



STATE OF CALIFORNIA DEPARTMENT OF GENERAL SERVICES

**REAL ESTATE SERVICES DIVISION
PROJECT MANAGEMENT AND DEVELOPMENT BRANCH**

PROJECT MANUAL – Book III of IV

INTRODUCTORY INFORMATION
APPENDICES (Continued)

APPENDIX 1 (Continued) – PREVIOUSLY ISSUED ADDITIONAL DETAILED INSTRUCTIONS, ADDED SPECIFICATIONS, SUBMITTALS, AND CUT SHEETS

FOR:

DSH METROPOLITAN SNF BLDG REPAIR PROJECT

DEPARTMENT OF STATE HOSPITALS

11401 BLOOMFIELD AVE

**NORWALK, LOS ANGELES COUNTY, CALIFORNIA
90650**

Thomas Brunet, Project Director
West Sacramento, California

Consultants: J C Chang and Associates, Inc.

May 2022

DGS00000142412C

DOCUMENT 00 01 01

PROJECT TITLE PAGE

Title: DSH METROPOLITAN SNF BLDG REPAIR PROJECT

Client Agency: DEPARTMENT OF STATE HOSPITALS

Location: 11401 BLOOMFIELD AVE, NORWALK CA ,
LOS ANGELES COUNTY, CALIFORNIA

Project Number : DGS00000142412C

Project Director : Thomas Brunet
State of California
Department of General Services
Real Estate Services Division
Project Management and Development Branch
707 Third Street, 4th Floor
West Sacramento, California 95605
Telephone Number: (916) 995-2993
Email: thomas.brunet@dgs.ca.gov

Consultant : J C Chang & Associates Inc.
Ramy Eskander
385 Van Ness Avenue, Suite 208
Torrance, California 90501
Telephone Number: (310) 212 7644
Email: REskander@jccainc.com

CERTIFICATIONS PAGE

PROJECT TITLE : DSH METROPOLITAN SNF BLDG REPAIR PROJECT

CLIENT AGENCY : DEPARTMENT OF STATE HOSPITALS

LOCATION : NORWALK CA, LOS ANGELES COUNTY, CALIFORNIA

PROJECT NUMBER : DGS00000142412C

OWNER : STATE OF CALIFORNIA

PROJECT DIRECTOR : Thomas Brunet
 Department of General Services
 Project Management and Development Branch
 707 Third Street, 4th Floor
 West Sacramento, California 95605
 Telephone Number: (916) 995-2993
 Email : thomas.brunet@dgs.ca.gov

CONSULTANT : J C Chang & Associates Inc.
 Ramy Eskander

		
ARCHITECT	CIVIL ENGINEER	STRUCTURAL ENGINEER
ELECTRICAL ENGINEER	MECHANICAL ENGINEER	LANDSCAPE ARCHITECT

PROJECT TITLE : DSH METROPOLITAN SNF BLDG REPAIR PROJECT
 CLIENT AGENCY : DEPARTMENT OF STATE HOSPITALS
 LOCATION : NORWALK CA, LOS ANGELES COUNTY, CALIFORNIA
 PROJECT NO. : DGS00000142412C

REGULATORY REVIEWS:

<p> Office of the State Fire Marshal Reviewed, No Exception Taken Jason Chavez, DSFM III Date <u>6/13/2022</u> </p>	
<p>STATE FIRE MARSHAL</p>	<p>ACCESS COMPLIANCE</p>
<p>OSHPD</p>	

DOCUMENT 00 01 10

TABLE OF CONTENTS

BOOK I

INTRODUCTORY INFORMATION

	Pages
Document 00 01 01 Project Title Page	1 only
00 01 05 Certifications Page.....	1 through 2
00 01 10 Table of Contents	1 through 3
00 01 15 List of Drawings	1 through 2

BIDDING REQUIREMENTS

Document 00 11 00 Invitation to Bid	1 through 2
00 21 00 Instructions to Bidders	1 through 10
Appendix 00 21 00.1, Request for Bidding Interpretation	1 only
00 22 00 Supplementary Instructions to Bidders	1 through 2
00 22 10 DVBE Participation Program Requirements	1 through 3
00 41 00 Bid Form (Sample).....	1 through 11
00 45 46 Payee Data Record.....	1 through 2

CONTRACTING REQUIREMENTS

Document 00 52 00 Agreement (Sample).....	1 only
00 61 13 Performance Bond (Sample).....	1 only
00 61 14 Payment Bond (Sample).....	1 only
00 63 63 Construction Contract Change Order (Sample).....	1 only
00 72 00 General Conditions of the Contract for Construction	1 through 31
00 73 00 Supplementary Conditions	1 through 14

SPECIFICATIONS

DIVISION 01 - GENERAL REQUIREMENTS

Section 01 11 00 Summary	1 through 5
01 21 00 Allowances	1 through 2
01 31 00 Project Management and Coordination	1 through 2
01 31 25 Web based Project Management System	1 through 4
01 32 16 Progress Schedules and Reports	1 through 6
01 32 33 Construction Photographs.....	1 through 2
01 33 00 Submittal Procedures.....	1 through 6
01 33 29.08 Buy Clean California Report.....	1 through 2
01 35 16 Alteration Project Procedures	1 through 3
01 35 54 Hospital Project Procedures.....	1 through 3
01 41 00 Quality Requirements	1 through 2
01 51 00 Temporary Facilities and Controls.....	1 through 3
01 60 00 Product Requirements	1 through 2
01 73 29 Cutting and Patching.....	1 through 2
01 74 19 Construction Waste Management.....	1 through 3
Appendix 01 74 19.1, Construction Waste Estimate.....	1 only
Appendix 01 74 19.2, Waste Management Report.....	1 through 2
01 74 20 Recycled Content Certification.....	1 through 2
Appendix 01 74 20.1, Ex. Recycled Content Certification Worksheet	1 through 3
Appendix 01 74 20.2, Example SABRC Procurement Summary.....	1 through 2

01 74 23	Cleaning	1 through 2
01 77 00	Closeout Procedures	1 through 5
	STD 817 Prime contractor's certification – Subcontractor Report	1 through 5
	Appendix 01 77 00, A-1, Contractors Certification of SB Participation.....	1 only
	Appendix 01 77 00, A-2, Contractor's Certification of SB Participation, Preliminary & Final Report.....	1 only

DIVISION 07 - THERMAL AND MOISTURE PROTECTION

Section	07 82 00	Board Fire Protection	1 through 4
	07 84 43	Joint Firestopping	1 through 6
	07 92 00	Joint Sealants	1 through 8

DIVISION 08 – OPENINGS

Section	08 31 13	Access Doors and Frames	1 through 6
---------	----------	-------------------------------	-------------

DIVISION 09 - FINISHES

Section	09 10 90.52	Maintenance Repainting	1 through 14
	09 22 16	Non-Structural Metal Framing	1 through 8
	09 24 00	Cement Plastering	1 through 8
	09 29 00	Gypsum Board.....	1 through 8
	09 51 23	Acoustical Tile Ceilings	1 through 6
	09 65 13	Resilient Base and Accessories	1 through 6
	09 65 19	Resilient Tile Flooring	1 through 6
	09 91 23	Interior Painting.....	1 through 8

DIVISION 12 – FURNISHINGS

Section	12 32 16	Manufactured Plastic Laminate Clad Casework	1 through 10
	12 36 23.13	Plastic Laminate Clad Countertops	1 through 8

BOOK II - APPENDICES

APPENDIX 1- PREVIOUSLY ISSUED ADDITIONAL DETAILED INSTRUCTIONS (ADI), ADDED SPECIFICATIONS, SUBMITTALS, AND CUT SHEETS

ADI 01.1 ISSUED TO KAZONI CONSTRUCTION (PART 1)

ADI 1.1	Cover Sheet – JCCA to Kazoni Construction	1 only
ADI 1.1	Plan Sheet Edits (showing door locations)	1 through 5
ADI 1.1	DSH-Metropolitan SNF BLDG Punch Report	1 through 348

BOOK III – APPENDICES (Continued)

APPENDIX 1 (Cont.)- PREVIOUSLY ISSUED ADDITIONAL DETAILED INSTRUCTIONS, ADDED SPECIFICATIONS, SUBMITTALS, AND CUT SHEETS

ADI 1.1 ISSUED TO KAZONI CONSTRUCTION (PART 2)

ADI 1.1.	DSH-Metropolitan SNF BLDG - Fire Door Inspection Report	1 through 261
ADI 1.1	Door Schedule Report	1 through 12
ADI 1.1	Corrective Action Report.....	1 through 24

ADI 2.0 ISSUED TO KAZONI CONSTRUCTION

ADI 2.0 – JCCA to Kazoni Construction re. Ductwork.....	1 through 2
---	-------------

ADI 3.0 ISSUED TO SJ AMOROSO

ADI 3.0 – JCCA to SJ Amoroso re. product assembly detail.....	1 through 3
---	-------------

ADDED SPECIFICATIONS

08 31 13	Access Doors and Frames (Add. No. 3 Kazoni 6/15/2022)	1 through 6
12 32 16	Manufactured Plastic-Laminate-Clad Casework.....	1 through 10
12 36 23.13	Plastic-Laminate-Clad Countertops.....	1 through 8

SUBMITTALS FROM KAZONI CONSTRUCTION

Submittal 17R2 – Polystyrene Core Transom	1 through 5
---	-------------

ADDED CUT SHEETS

Paint Cut Sheets – Color, Primer, Wood Stain.....	1 through 6
---	-------------

BOOK IV – APPENDICES (Continued)

APPENDIX 2 - REQUESTS FOR INFORMATION (RFI) RESPONSES TO KAZONI AND TO S.J. AMOROSO

RFI RESPONSES TO KAZONI CONSTRUCTION

RFI 16	Response from JCCA - Millwork Damage	1 through 3
RFI 39	Response from JCCA – Door Schedule	1 through 67
RFI 39.1	Response from JCCA – Door Schedule Clarifications	1 through 2
RFI 51	Response from JCCA – Possible Mold Growing on Walls.....	1 through 8
RFI 69	Response from JCCA – Millwork at Dentist Office	1 through 4
RFI 71	Response from JCCA – Millwork at Dining Area	1 through 6
RFI 72R1	Response from JCCA – Existing Pipe Penetrations	1 through 11
RFI 76	Response from JCCA – Low Voltage Box for Wi-Fi.....	1 through 2
RFI 80R1	Response from JCCA – Seismic Light Wire at Suspended Ceiling.....	1 through 8
RFI 81	Response from JCCA – Unsupported Electrical.....	1 through 61
RFI 84	Response from JCCA – Day Room and Cafeteria Lighting	1 through 11

RFI RESPONSES TO S.J. AMOROSO

RFI 21	Response from JCCA – Plumbing Observations – Unit 419 & 420.....	1 through 3
RFI 21.1	Response from JCCA – Plumbing Observations – Unit 418.....	1 through 2
RFI 21.2	Response from JCCA – Plumbing Observations – Units 417 & A	1 through 3
RFI 26	Response from JCCA – Sewer System Jetting	1 through 6
RFI 28	Response from JCCA – Negative Aire Pressure Machine.....	1 only
RFI 30	Response from JCCA – Use of Remote Volume Dampers.....	1 through 24

END OF DOCUMENT

DOCUMENT 00 01 15

LIST OF DRAWINGS

Sheet Number

Description

GENERAL

T 01

TITLE SHEET INDEX, NOTES

ARCHITECTURAL

A1.1	UNIT 417 - EXISTING CONDITIONS PHOTOGRAPH PLAN
A1.1.1	UNIT 417 - EXISTING CONDITIONS PHOTOGRAPHS
A1.2	UNIT 418 - EXISTING CONDITIONS PHOTOGRAPH PLAN
A1.2.1	UNIT 418 - EXISTING CONDITIONS PHOTOGRAPHS
A1.2.2	UNIT 418 - EXISTING CONDITIONS PHOTOGRAPHS
A1.3	UNIT A SNF- EXISTING CONDITIONS PHOTOGRAPHS PLAN
A1.3.1	UNIT A SNF- EXISTING CONDITIONS PHOTOGRAPHS
A1.3.2	UNIT A SNF- EXISTING CONDITIONS PHOTOGRAPHS
A1.4	UNIT 419 - EXISTING CONDITIONS PHOTOGRAPHS
A1.4.1	UNIT 419 - EXISTING CONDITIONS PHOTOGRAPHS
A1.5	UNIT 420 - EXISTING CONDITIONS PHOTOGRAPHS PLAN
A1.5.1	UNIT 420 - EXISTING CONDITIONS PHOTOGRAPHS
A1.5.2	UNIT 420 - EXISTING CONDITIONS PHOTOGRAPHS
A1.6	UNIT 417 - EXISTING CONDITIONS PHOTOGRAPH PLAN
A1.6.1	UNIT 417 - EXISTING CONDITIONS PHOTOGRAPHS
A1.6.2	UNIT 417 - EXISTING CONDITIONS PHOTOGRAPHS
A1.6.3	UNIT 417 - EXISTING CONDITIONS PHOTOGRAPHS
A1.7	UNIT 418 - EXISTING CONDITIONS PHOTOGRAPH PLAN
A1.7.1	UNIT 418 - EXISTING CONDITIONS PHOTOGRAPHS
A1.8	UNIT A SNF - EXISTING CONDITIONS PHOTOGRAPH PLAN
A1.8.1	UNIT A SNF - EXISTING CONDITIONS PHOTOGRAPHS
A1.8.2	UNIT A SNF - EXISTING CONDITIONS PHOTOGRAPHS
A1.9	UNIT 419 - EXISTING CONDITIONS PHOTOGRAPH PLAN
A1.9.1	UNIT 419 - EXISTING CONDITIONS PHOTOGRAPHS
A1.9.2	UNIT 419 - EXISTING CONDITIONS PHOTOGRAPHS
A1.10	UNIT 420 - EXISTING CONDITIONS PHOTOGRAPH PLAN
A1.10.1	UNIT 420 - EXISTING CONDITIONS PHOTOGRAPHS
A2.1	UNIT 417 CEILING PLAN
A2.1.1	UNIT 417 CEILING FINISH PLAN / ADDED REPAIRS
A2.1.2	UNIT 417 FINISH AND CASEWORK PLAN / ADDED REPAIRS
A2.2	UNIT 418 CEILING PLAN
A2.2.1	UNIT 418 CEILING FINISH PLAN / ADDED REPAIRS
A2.2.2	UNIT 418 FINISH AND CASEWORK PLAN / ADDED REPAIRS
A2.3	UNIT A SNF CEILING PLAN
A2.3.1	UNIT A SNF CEILING FINISH PLAN / ADDED REPAIRS
A2.3.2	UNIT A SNF FINISH AND CASEWORK PLAN / ADDED REPAIRS
A2.4	UNIT 419 CEILING PLAN
A2.4.1	UNIT 419 CEILING FINISH PLAN / ADDED REPAIRS
A2.4.2	UNIT 419 FINISH AND CASEWORK PLAN / ADDED REPAIRS
A2.5	UNIT 420 CEILING PLAN

LIST OF DRAWINGS

00 01 15 - 1

RESDMSTR: 02/03/2014

DGS00000142142C

A2.5.1	UNIT 420 CEILING FINISH PLAN / ADDED REPAIRS
A2.5.2	UNIT 420 FINISH AND CASEWORK PLAN / ADDED REPAIRS
A3.1	DETAILS
A3.2	DETAILS
A3.3	DETAILS
A3.4	DETAILS
A4.1	UNIT A - ENLARGED CABINETS PLANS AND ELEVATIONS
A4.2	UNIT 417 - ENLARGED CABINETS PLANS AND ELEVATIONS
A4.3	UNIT 418 - ENLARGED CABINETS PLANS AND ELEVATIONS
A4.4	UNIT 419 - ENLARGED CABINETS PLANS AND ELEVATIONS

END OF DOCUMENT

DSH-METROPOLITAN SNF BLDG

Fire Door Inspection Report

Review Dates From 10-16-2023 To 10-19-2023

OWNER**FIRE DOOR INSPECTION****PROJECT****DATE(S)**

DSH-METROPOLITAN SNF BLDG

10-16-2023 - 10-19-2023

Scope of Services

The fire door and smoke door (as applicable) openings described in the Door Inspection List at the project location and dates were inspected and noted as "Compliant, Non-Compliant or Not Inspected" as determined by an ASSA ABLOY EDSSG professional inspector(s). The guidelines used for inspection and compliance were based on The National Fire Protection Association (NFPA) Standard "NFPA 80 - Standard for Fire Doors and Other Opening Protectives" Section 5.2.4 and "NFPA 105 - Standard for Smoke Door Assemblies and Other Opening Protectives" Section 5.2.1 (as applicable).

The purpose of the summary report, and associated digital images, is to describe the location and deficiencies of the inspected "Non- Compliant" door openings with the respective NFPA Standard as of the date of inspection. The inspection report is not intended to constitute a warranty as to the continued compliance or functional operation of any of the door openings and associated hardware or access control systems.

ASSA ABLOY EDSSG is held harmless from and against damages incurred as a result of variances from any building codes or regulations in place by the authority having jurisdiction ("AHJ") over the Owner or its facilities that impact the inspection services provided (such as the Joint Commission on Accreditation of Health Care Organizations, Centers for Medicare and Medicaid Services, local fire protection agencies, and the Owner's insurance company) if ASSA ABLOY EGSSG is not informed of such requirements in advance by the Owner.

This summary report is provided in conjunction with the project inspection services performed by an ASSA ABLOY EDSSG inspector(s) and does not cover cost of repair or any other services with respect to the openings.

Questions regarding this summary report can be directed to the following Openings Studio Building Technologies Consultant:

NAME OF INSPECTOR: Jeremy Hoyos

CONTACT INFORMATION: jeremy.hoyos@assaabloy.com

SIGNATURE: _____

GENERAL COMMENTS: .

Majority of all perimeter gasketing missing or needs replacement.
All door lock wraps are non-compliant, recommend AHJ sign off for continued use.
All doors with mag holds missing wall mounted hold.
All 103 doors are exterior custom plywood doors and frames.

Fire Ratings & Issue Type Breakdown
 Total Number of Openings: 228

Fire Ratings

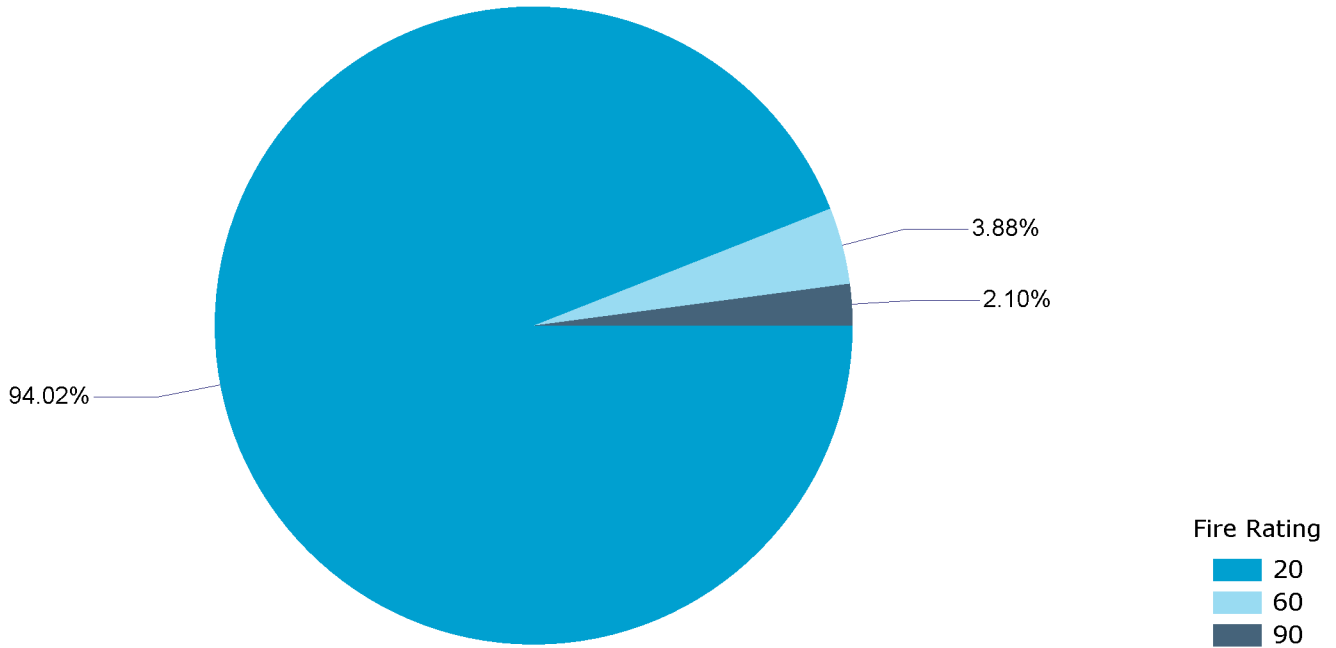

Issue Type Breakdown

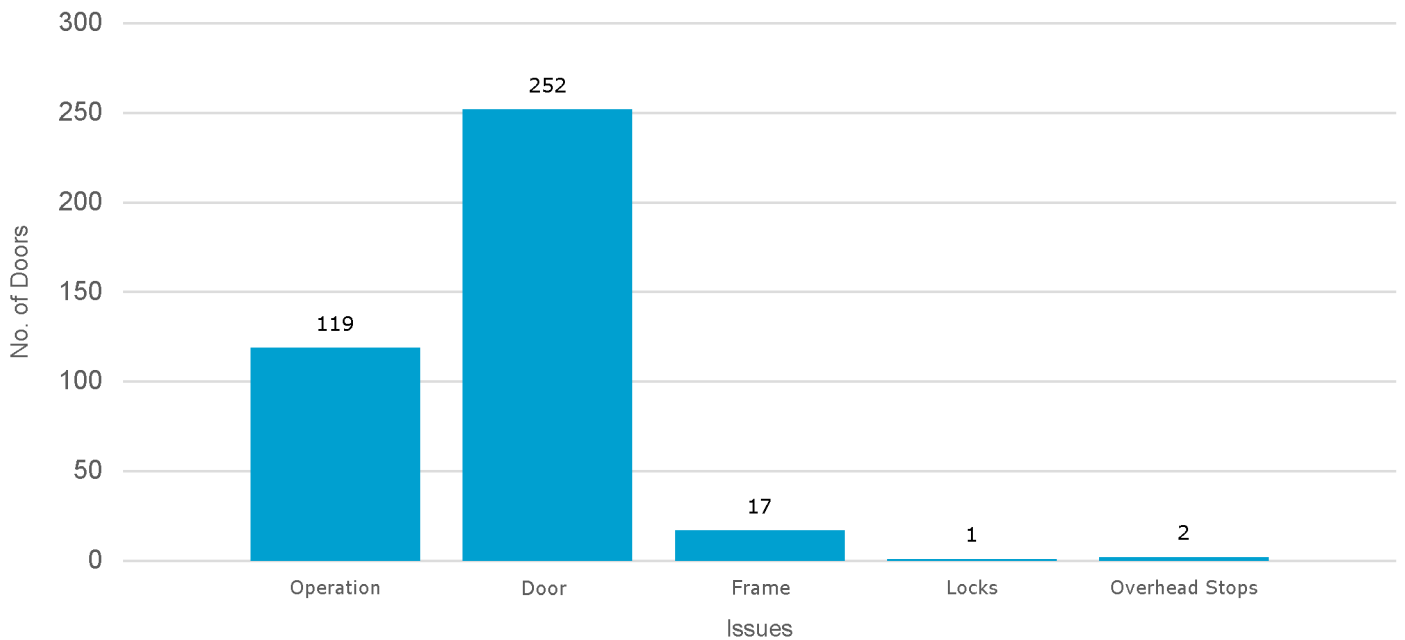

Door Inspection List

Mark	Building	Level	Fire Rating	Smoke Rating	Acoustic Rating	Opening Status	Issue Codes	Date	Technician
417-101A	SNF	417	FR-20			Non-Compliant	D9	10-18-2023	j Mcburnett
417-101E	SNF	417	FR-20			Non-Compliant	D4, D3, D2, F4	10-18-2023	V Evans
417-102	SNF	417	FR-60			Non-Compliant	D2, F4	10-18-2023	V Evans
417-104A	SNF	417	FR-20			Non-Compliant	D9	10-18-2023	j Mcburnett
417-107A	SNF	417	FR-20			Non-Compliant	D2, D9	10-18-2023	j Mcburnett
417-108	SNF	417	FR-20			Non-Compliant	F4, D3	10-18-2023	j Mcburnett
417-112	SNF	417	FR-20			Non-Compliant	D9	10-18-2023	j Mcburnett
417-113	SNF	417	FR-20			Non-Compliant	D9	10-18-2023	j Mcburnett
417-114	SNF	417	FR-20			Non-Compliant	D9	10-18-2023	j Mcburnett
417-115	SNF	417	FR-20			Non-Compliant	F4	10-18-2023	j Mcburnett
417-116	SNF	417	FR-20			Non-Compliant	D9, F4	10-18-2023	j Mcburnett
417-117	SNF	417	FR-20			Non-Compliant	D9, F4	10-18-2023	j Mcburnett
417-118	SNF	417	FR-20			Non-Compliant	F4, D9	10-18-2023	j Mcburnett
417-119	SNF	417	FR-20			Non-Compliant	D9, D2	10-18-2023	V Evans
417-120	SNF	417	FR-60			Non-Compliant	F4, D9, D2	10-18-2023	V Evans
417-121	SNF	417	FR-20			Non-Compliant	F4, D9, D2	10-18-2023	V Evans
417-122	SNF	417	FR-20			Non-Compliant	D2, D9	10-18-2023	V Evans
417-124	SNF	417	FR-20			Non-Compliant	D2, F4, D9	10-18-2023	V Evans
417-125	SNF	417	FR-20			Non-Compliant	D2, D9	10-18-2023	V Evans
417-126	SNF	417	FR-20			Non-Compliant	O2, D9, F4	10-18-2023	V Evans
417-127	SNF	417	FR-20			Non-Compliant	D9, D2, F4	10-18-2023	V Evans
419-129	SNF	419	FR-20			Non-Compliant	F4, D9	10-17-2023	j Mcburnett
417-131A	SNF	417	FR-20			Non-Compliant	D2, D9	10-18-2023	j Mcburnett
417-133	SNF	417	FR-20			Non-Compliant	D2, D9, F4	10-18-2023	j Mcburnett
417-135	SNF	417	FR-20			Non-Compliant	D2, D9, F4	10-18-2023	j Mcburnett
417-136	SNF	417	FR-20			Non-Compliant	F4, D2, D9	10-18-2023	j Mcburnett
417-137	SNF	417	FR-20			Non-Compliant	D9, F4, D2	10-18-2023	j Mcburnett

Door Inspection List

Mark	Building	Level	Fire Rating	Smoke Rating	Acoustic Rating	Opening Status	Issue Codes	Date	Technician
417-139	SNF	417	FR-20			Non-Compliant	F4, D2, D9	10-18-2023	j Mcburnett
417-141	SNF	417	FR-20			Non-Compliant	D2	10-18-2023	j Mcburnett
417-142	SNF	417	FR-20			Non-Compliant	F4	10-18-2023	j Mcburnett
417-145	SNF	417	FR-20			Non-Compliant	F4, D9, D2	10-18-2023	j Mcburnett
417-146	SNF	417	FR-20			Non-Compliant	F4, D9, D2	10-18-2023	j Mcburnett
417-147	SNF	417	FR-60			Non-Compliant	D2	10-18-2023	j Mcburnett
417-148	SNF	417	FR-20			Non-Compliant	O5, F4, D2	10-18-2023	V Evans
417-150	SNF	417	FR-20			Non-Compliant	D2, D9, F2, F4	10-18-2023	V Evans
417-151	SNF	417	FR-20			Non-Compliant	F4, D9, D2	10-18-2023	V Evans
417-152	SNF	417	FR-20			Non-Compliant	F4, O5, D9, D2	10-18-2023	V Evans
417-153	SNF	417	FR-20			Non-Compliant	D2, F4, D9	10-18-2023	j Mcburnett
417-155	SNF	417	FR-20			Non-Compliant	F4, D2, D9	10-18-2023	j Mcburnett
417-156	SNF	417	FR-20			Non-Compliant	D2, D9, F4	10-18-2023	j Mcburnett
417-157	SNF	417	FR-20			Non-Compliant	D9, F4	10-18-2023	j Mcburnett
417-C100	SNF	417	FR-20			Non-Compliant	F4, D2	10-18-2023	j Mcburnett
418-101E	SNF	418	FR-20			Non-Compliant	D2	10-19-2023	j Mcburnett
418-102	SNF	418	FR-60			Non-Compliant	D2, F4, F2, F3, O5	10-18-2023	V Evans
418-104A	SNF	418	FR-20			Non-Compliant	D2	10-18-2023	V Evans
418-104B	SNF	418	FR-20			Non-Compliant	F4, D2	10-18-2023	V Evans
418-108	SNF	418	FR-90			Non-Compliant	D2	10-19-2023	j Mcburnett
418-109	SNF	418	FR-20			Non-Compliant	D2	10-19-2023	j Mcburnett
418-110	SNF	418	FR-20			Non-Compliant	D2	10-19-2023	j Mcburnett
418-111	SNF	418	FR-20			Non-Compliant	D2	10-19-2023	j Mcburnett
418-112	SNF	418	FR-20			Non-Compliant	D9	10-19-2023	j Mcburnett
418-113	SNF	418	FR-20			Non-Compliant	D2	10-19-2023	j Mcburnett
418-114	SNF	418	FR-20			Compliant		10-19-2023	j Mcburnett
418-115	SNF	418	FR-20			Non-Compliant	D9	10-19-2023	j Mcburnett

Door Inspection List

Mark	Building	Level	Fire Rating	Smoke Rating	Acoustic Rating	Opening Status	Issue Codes	Date	Technician
418-116	SNF	418	FR-20			Non-Compliant	D9	10-19-2023	j Mcburnett
418-117	SNF	418	FR-20			Non-Compliant	D9	10-19-2023	j Mcburnett
418-118	SNF	418	FR-20			Non-Compliant	D9, O5	10-19-2023	j Mcburnett
418-121	SNF	418	FR-20			Non-Compliant	D9	10-19-2023	j Mcburnett
418-122	SNF	418	FR-20			Non-Compliant	D2	10-19-2023	V Evans
418-123	SNF	420	FR-90			Non-Compliant	D2, O5	10-19-2023	V Evans
418-125	SNF	418	FR-20			Non-Compliant	D9, D2	10-19-2023	V Evans
418-126	SNF	418	FR-20			Non-Compliant	D2	10-19-2023	V Evans
418-128	SNF	418	FR-20			Non-Compliant	F4, D2, D9	10-19-2023	V Evans
418-129	SNF	418	FR-20			Non-Compliant	D2	10-19-2023	V Evans
418-130	SNF	418	FR-20			Non-Compliant	O5, D2, F4	10-19-2023	V Evans
418-132	SNF	418	FR-20			Non-Compliant	D2	10-19-2023	j Mcburnett
418-133	SNF	418	FR-20			Non-Compliant	F4, D2, D9	10-19-2023	j Mcburnett
418-134	SNF	418	FR-20			Non-Compliant	D2	10-18-2023	j Mcburnett
418-135	SNF	418	FR-20			Non-Compliant	D9	10-18-2023	j Mcburnett
418-136	SNF	418	FR-20			Non-Compliant	D9	10-18-2023	j Mcburnett
418-137	SNF	418	FR-20			Compliant		10-18-2023	j Mcburnett
418-139	SNF	418	FR-20			Non-Compliant	D2, F4	10-18-2023	j Mcburnett
418-140	SNF	418	FR-20			Non-Compliant	D2	10-18-2023	j Mcburnett
418-141	SNF	418	FR-20			Non-Compliant	D2	10-18-2023	j Mcburnett
418-142	SNF	418	FR-20			Compliant		10-18-2023	j Mcburnett
418-143	SNF	418	FR-20			Compliant		10-18-2023	j Mcburnett
418-144	SNF	418	FR-20			Non-Compliant	D9, F4	10-18-2023	j Mcburnett
418-145	SNF	418	FR-20			Non-Compliant	D2	10-18-2023	j Mcburnett
418-146	SNF	418	FR-60			Non-Compliant	D2, F2	10-18-2023	j Mcburnett
418-147	SNF	418	FR-20			Non-Compliant	D9	10-18-2023	j Mcburnett
418-148	SNF	418	FR-20			Non-Compliant	D2	10-19-2023	j Mcburnett

Door Inspection List

Mark	Building	Level	Fire Rating	Smoke Rating	Acoustic Rating	Opening Status	Issue Codes	Date	Technician
418-149	SNF	418	FR-20			Non-Compliant	F4, D9	10-18-2023	j Mcburnett
418-150	SNF	418	FR-20			Non-Compliant	D2	10-18-2023	j Mcburnett
418-151	SNF	418	FR-20			Non-Compliant	D2	10-18-2023	j Mcburnett
418-152	SNF	418	FR-20			Non-Compliant	D9	10-18-2023	j Mcburnett
418-153	SNF	418	FR-20			Non-Compliant	D9	10-18-2023	j Mcburnett
418-154	SNF	418	FR-20			Non-Compliant	D9	10-18-2023	j Mcburnett
418-155	SNF	418	FR-20			Non-Compliant	D9	10-18-2023	j Mcburnett
418-156	SNF	418	FR-20			Compliant		10-18-2023	j Mcburnett
418-157	SNF	418	FR-20			Compliant		10-18-2023	j Mcburnett
418-162	SNF	418	FR-20			Non-Compliant	D2	10-19-2023	j Mcburnett
418-C100	SNF	418	FR-20			Non-Compliant	D2	10-18-2023	j Mcburnett
419-101A	SNF	419	FR-20			Non-Compliant	D9	10-17-2023	j Mcburnett
419-101B	SNF	419	FR-20			Non-Compliant	O1	10-17-2023	j Mcburnett
419-102	SNF	419	FR-20			Non-Compliant	F4, D3	10-17-2023	j Mcburnett
419-104A	SNF	419	FR-20			Non-Compliant	F4, O5, D3	10-17-2023	j Mcburnett
419-108	SNF	419	FR-90			Non-Compliant	D2	10-17-2023	j Mcburnett
419-109	SNF	419	FR-20			Non-Compliant	D2, F4	10-17-2023	V Evans
419-110	SNF	419	FR-20			Non-Compliant	D2	10-17-2023	j Mcburnett
419-111	SNF	419	FR-20			Non-Compliant	D2	10-17-2023	j Mcburnett
419-113	SNF	419	FR-20			Non-Compliant	D9	10-17-2023	j Mcburnett
419-115	SNF	419	FR-20			Non-Compliant	D9	10-17-2023	j Mcburnett
419-116	SNF	419	FR-20			Non-Compliant	D9	10-17-2023	j Mcburnett
419-117	SNF	419	FR-20			Non-Compliant	D9, F4	10-17-2023	j Mcburnett
419-118	SNF	419	FR-20			Non-Compliant	D9	10-17-2023	j Mcburnett
419-122	SNF	419	FR-20			Compliant		10-17-2023	j Mcburnett
419-123	SNF	419	FR-90			Non-Compliant	D2	10-17-2023	j Mcburnett
419-125	SNF	419	FR-20			Non-Compliant	D9	10-17-2023	j Mcburnett

Door Inspection List

Mark	Building	Level	Fire Rating	Smoke Rating	Acoustic Rating	Opening Status	Issue Codes	Date	Technician
419-126	SNF	419	FR-20			Compliant		10-17-2023	j Mcburnett
419-127	SNF	419	FR-20			Non-Compliant	D2, D9, F4	10-17-2023	j Mcburnett
417-128	SNF	417	FR-20			Non-Compliant	F4, D9	10-18-2023	V Evans
417-129	SNF	417	FR-20			Non-Compliant	F4, D9, D2	10-18-2023	V Evans
417-130	SNF	417	FR-20			Non-Compliant	F4, D2, D9	10-18-2023	V Evans
419-132	SNF	419	FR-20			Non-Compliant	D2, F4, F2, D3, O5	10-17-2023	V Evans
419-133	SNF	419	FR-20			Non-Compliant	D9, D2	10-17-2023	V Evans
419-134	SNF	419	FR-20			Non-Compliant	D2	10-17-2023	V Evans
419-135	SNF	419	FR-20			Non-Compliant	D9, F4	10-17-2023	V Evans
419-136	SNF	419	FR-20			Non-Compliant	D2, D8, F4	10-17-2023	V Evans
419-137	SNF	419	FR-20			Compliant		10-17-2023	V Evans
419-139	SNF	419	FR-20			Non-Compliant	O5, D9	10-17-2023	V Evans
419-140	SNF	419	FR-20			Non-Compliant	D2	10-17-2023	V Evans
419-141	SNF	419	FR-20			Non-Compliant	D2, D9, F4	10-17-2023	V Evans
419-142	SNF	419	FR-20			Non-Compliant	D9, D3	10-17-2023	V Evans
419-143	SNF	419	FR-20			Non-Compliant	D2	10-17-2023	V Evans
419-145	SNF	419	FR-20			Non-Compliant	D2	10-17-2023	V Evans
419-146	SNF	419	FR-20			Non-Compliant	F4, D3	10-17-2023	V Evans
419-147	SNF	419	FR-20			Non-Compliant	D2, F4	10-17-2023	V Evans
419-150	SNF	419	FR-20			Non-Compliant	D2, F4	10-17-2023	j Mcburnett
419-152	SNF	419	FR-20			Non-Compliant	F4, D9	10-17-2023	j Mcburnett
419-153	SNF	419	FR-20			Non-Compliant	D9	10-17-2023	j Mcburnett
419-155	SNF	419	FR-20			Non-Compliant	F4, D2, D9	10-17-2023	j Mcburnett
419-156	SNF	419	FR-20			Non-Compliant	D2	10-17-2023	j Mcburnett
419-157	SNF	419	FR-20			Non-Compliant	D2	10-17-2023	j Mcburnett
419-158	SNF	419	FR-20			Non-Compliant	LO1	10-17-2023	j Mcburnett
419-C100	SNF	419	FR-20			Non-Compliant	D2	10-17-2023	j Mcburnett

Door Inspection List

Mark	Building	Level	Fire Rating	Smoke Rating	Acoustic Rating	Opening Status	Issue Codes	Date	Technician
420-101A	SNF	420	FR-20			Non-Compliant	F4, D2	10-18-2023	V Evans
420-101B	SNF	420	FR-20			Non-Compliant	D2, D9, F4	10-18-2023	j Mcburnett
420-102	SNF	420	FR-20			Non-Compliant	F4, D2	10-18-2023	V Evans
420-104A	SNF	420	FR-20			Non-Compliant	F4, D9	10-18-2023	j Mcburnett
420-108	SNF	420	FR-90			Non-Compliant	D2	10-18-2023	j Mcburnett
420-109	SNF	420	FR-60			Non-Compliant	F4, D2	10-18-2023	j Mcburnett
420-110	SNF	420	FR-20			Non-Compliant	F4, D2	10-18-2023	j Mcburnett
420-111	SNF	420	FR-20			Non-Compliant	D2, D9, F4	10-18-2023	j Mcburnett
420-112	SNF	420	FR-20			Non-Compliant	F4, D9	10-18-2023	j Mcburnett
420-113	SNF	420	FR-20			Non-Compliant	F4, D2	10-18-2023	j Mcburnett
420-114	SNF	420	FR-20			Compliant		10-18-2023	j Mcburnett
420-115	SNF	420	FR-20			Non-Compliant	D2, F4	10-18-2023	j Mcburnett
420-116	SNF	420	FR-20			Non-Compliant	D2, D9, F4	10-18-2023	j Mcburnett
420-117	SNF	420	FR-20			Non-Compliant	F4, D9	10-18-2023	j Mcburnett
420-118	SNF	420	FR-20			Non-Compliant	F4, D9	10-18-2023	j Mcburnett
420-121	SNF	420	FR-20			Non-Compliant	D2	10-18-2023	V Evans
420-122	SNF	420	FR-20			Non-Compliant	D2, O5, F4	10-18-2023	V Evans
420-124	SNF	420	FR-20			Non-Compliant	F4, D2, D9, O5	10-18-2023	V Evans
420-125	SNF	420	FR-20			Non-Compliant	F4, D9, D2, O5, D3	10-18-2023	V Evans
420-126	SNF	420	FR-20			Non-Compliant	D2, D9	10-18-2023	V Evans
420-127	SNF	420	FR-20			Non-Compliant	D2, F4, D9	10-18-2023	V Evans
420-129	SNF	420	FR-20			Non-Compliant	D3, OT, F4, D9, D2	10-18-2023	V Evans
420-130	SNF	420	FR-20			Non-Compliant	D3, F4, D9, D2	10-18-2023	V Evans
420-132	SNF	420	FR-20			Non-Compliant	F4	10-18-2023	j Mcburnett
420-133	SNF	420	FR-20			Non-Compliant	F4, D9	10-18-2023	j Mcburnett
420-134	SNF	420	FR-20			Non-Compliant	D2, F4	10-18-2023	j Mcburnett
420-135	SNF	420	FR-20			Non-Compliant	F4, D9, D2	10-18-2023	j Mcburnett

Door Inspection List

Mark	Building	Level	Fire Rating	Smoke Rating	Acoustic Rating	Opening Status	Issue Codes	Date	Technician
420-136	SNF	420	FR-20			Non-Compliant	F4, D9	10-18-2023	j Mcburnett
420-137	SNF	420	FR-20			Non-Compliant	F4, D9	10-18-2023	j Mcburnett
420-139	SNF	420	FR-20			Non-Compliant	D2, F4, D9	10-18-2023	j Mcburnett
420-140	SNF	420	FR-20			Non-Compliant	F4, D9	10-18-2023	j Mcburnett
420-141	SNF	420	FR-20			Non-Compliant	D9, F4	10-18-2023	j Mcburnett
420-142	SNF	420	FR-20			Non-Compliant	D2	10-18-2023	j Mcburnett
420-143	SNF	420	FR-20			Non-Compliant	F4, D2	10-18-2023	j Mcburnett
420-145	SNF	420	FR-20			Non-Compliant	D9	10-18-2023	j Mcburnett
420-146	SNF	420	FR-20			Non-Compliant	D9, F4	10-18-2023	j Mcburnett
420-147	SNF	420	FR-20			Non-Compliant	D9, F4	10-18-2023	j Mcburnett
420-148	SNF	420	FR-20			Non-Compliant	F4, D2	10-18-2023	V Evans
420-150	SNF	420	FR-20			Non-Compliant	D9, D2, F4, OT, D3	10-18-2023	V Evans
420-152	SNF	420	FR-20			Non-Compliant	D9, D2	10-18-2023	V Evans
420-153	SNF	420	FR-20			Non-Compliant	D3, F4, D9, D2	10-18-2023	V Evans
420-154	SNF	420	FR-20			Non-Compliant	D2, D9, F4	10-18-2023	V Evans
420-156	SNF	420	FR-20			Non-Compliant	F4, D3, D2, D9	10-18-2023	V Evans
420-157	SNF	420	FR-20			Compliant		10-18-2023	j Mcburnett
420-158	SNF	420	FR-20			Non-Compliant	D2	10-18-2023	j Mcburnett
420-162	SNF	420	FR-20			Non-Compliant	F4	10-18-2023	V Evans
420-C100	SNF	420	FR-20			Non-Compliant	D3, O5, F4	10-18-2023	j Mcburnett
A-103	SNF	A	FR-20			Non-Compliant	F4, D9	10-17-2023	j Mcburnett
A-114	SNF	A	FR-20			Non-Compliant	F4, D2	10-17-2023	j Mcburnett
A-116	SNF	A	FR-20			Non-Compliant	D2, F4	10-17-2023	j Mcburnett
A-118	SNF	A	FR-20			Non-Compliant	F4, D2	10-17-2023	j Mcburnett
A-119	SNF	A	FR-20			Non-Compliant	D2, F4	10-17-2023	j Mcburnett
A-122	SNF	A	FR-20			Non-Compliant	D9, D2, F4, D3	10-17-2023	V Evans
A-123	SNF	A	FR-20			Non-Compliant	D2, F4, D3	10-17-2023	V Evans

Door Inspection List

Mark	Building	Level	Fire Rating	Smoke Rating	Acoustic Rating	Opening Status	Issue Codes	Date	Technician
A-124	SNF	A	FR-20			Non-Compliant	D3, D2, F4	10-17-2023	V Evans
A-136B	SNF	A	FR-60			Non-Compliant	D2, F4	10-17-2023	V Evans
A-136C	SNF	A	FR-20			Non-Compliant	D2, F4	10-17-2023	j Mcburnett
A-142B	SNF	A	FR-20			Non-Compliant	D3, D1, F2, F4	10-17-2023	V Evans
A-143A	SNF	A	FR-20			Non-Compliant	D2, F4	10-17-2023	j Mcburnett
A-143B	SNF	A	FR-20			Non-Compliant	D2, F4	10-17-2023	j Mcburnett
A-147A	SNF	A	FR-20			Non-Compliant	O5, F4, D2	10-17-2023	j Mcburnett
A-147B	SNF	A	FR-20			Non-Compliant	F4, D2	10-17-2023	j Mcburnett
A-148A	SNF	A	FR-20			Non-Compliant	F4, D2	10-17-2023	j Mcburnett
A-149	SNF	A	FR-20			Non-Compliant	D4, F4, D3	10-17-2023	V Evans
A-151	SNF	A	FR-20			Non-Compliant	O5	10-17-2023	j Mcburnett
A-159	SNF	A	FR-20			Non-Compliant	D2, F4, D3	10-17-2023	V Evans
A-160	SNF	A	FR-20			Non-Compliant	F4, D3, D2	10-17-2023	V Evans
A-161	SNF	A	FR-20			Non-Compliant	D2, F4, D3	10-17-2023	V Evans

Issues Key

Operation Issues

- O1, Door does not swing freely
- O2, Door does not close completely
- O3, Door does not securely latch
- O4, Electric door release does not allow door to close
- O5, Door drags on floor, rubs frame/rubs other door
- O6, Paired doors are not coordinated
- O7, Incorrect clearance (top of door to frame)
- O8, Incorrect clearance (hinge edge to frame)
- O9, Incorrect clearance (lock edge to frame)
- O10, Incorrect clearance (between doors)
- O11, Incorrect clearance (door bottom to floor)
- O12, Door blocked

Frame Issues

- F1, Not secured to the wall
- F2, Damaged/rust through on frame
- F3, Frame is out of alignment
- F4, Missing/painted/illegible label
- F5, Incorrect glass installed
- F6, Broken/damaged glass
- F7, Missing glazing bead/glazing bead screws
- F8, Unused fastener holes/wrong frame prep
- F9, Improper field modification or repair

Door Issues

- D1, Rust-through on door
- D2, Door damaged (bent, dented, delaminating)
- D3, Missing/painted/illegible label
- D4, Incorrect/missing/broken glass
- D5, Missing glazing bead/lite kit screws
- D6, Incorrect lite kit installed
- D7, Loose lite kit
- D8, Unused fastener holes/wrong door prep
- D9, Improper field modification or repair
- D10, Improper plant-ons
- D11, Unapproved louver

Hinges/Pivots

- H1, Missing hinge(s)/Pivot
- H2, Incorrect hinge(s)/Pivot
- H3, Binding hinge(s)
- H4, Hinge fastener(s) stripped, missing or broken
- H5, Damaged/defective hinge(s)
- H6, Incorrectly shimmed

Door Bolts

- BO1, Missing/damaged/incorrect bolt
- BO2, Missing/damaged/incorrect strike
- BO3, Bolt(s) not engaged/aligned with strike
- BO4, Missing/incorrect rub plate(s)/fastener(s)

Locks

- LO1, Lock missing/damaged/not securely fastened
- LO2, Lock strike missing/damaged/out of alignment
- LO3, Latchbolt missing/damaged/incorrect application
- LO4, Non-fire rated latchbolt
- LO5, Latchbolt(s) not engaging strike/binding
- LO6, Lock/strike fastener(s) stripped, missing or broken
- LO7, Electric lock/maglocks not integrated with access control
- LO8, Electric lock/maglocks not integrated with fire alarm
- LO9, Unapproved deadbolt/latchbolt/hook

Electric Strike

- ES1, Electric strike missing/damaged/incorrect application
- ES2, Electric strike fastener(s) stripped, missing or broken
- ES3, Non-fire rated electric strike
- ES4, Electric strike not integrated with access control
- ES5, Electric strike not integrated with fire alarm

Protection Plates & Trim

- KP1, Protection plate missing label
- KP2, Protection plate fasteners stripped, missing or broken

Coordinators

- CO1, Coordinator missing/damaged
- CO2, Coordinator fastener(s) stripped, missing or broken
- CO3, Unacceptable quality/material/finish

Fire Exit Hardware

- MU1, Mullion missing/broken/not securely fastened
- MU2, Mullion fastener(s) stripped, missing or broken
- ED1, Missing fire exit device
- ED2, Exit device is not fire rated (missing label)
- ED3, Missing/damaged latchbolt(s)/fire bolt(s)/components
- ED4, Missing/damaged vertical rod(s)
- ED5, Exit device/trim not securely fastened
- ED6, Exit device does not latch
- ED7, Exit device fastener(s) stripped, missing or broken
- ED8, Exit device not integrated with access control
- ED9, Exit device not integrated fire alarm
- ED10, Exit device actuating portion does not extend half of door width
- ED11, Special locking arrangements/access controlled egress doors are non-compliant
- ED12, Missing THIS DOOR TO REMAIN OPEN WHEN THE SPACE IS OCCUPIED sign
- ED13, Missing PUSH/PULL UNTIL ALARM SOUNDS, FREE EGRESS AFTER 15 SECONDS sign

Overhead Stops

- OH1, Overhead stop/holder missing/damaged/broken/installed incorrectly
- OH2, Mechanical hold-open installed
- OH3, Fastener(s) stripped, missing or broken

Door Closers

- CL1, Missing/damaged door closer(s)
- CL2, Leaking closer
- CL3, Missing/damaged/broken arm
- CL4, Does not close door completely
- CL5, Missing drop/adaptor plates
- CL6, Closer not securely fastened
- CL7, Closer cover missing/loose
- CL8, Closer fastener(s) stripped, missing or broken
- CL9, Hold-open/incorrect closer arm
- CL10, Closer parallel arm not pre-loaded when installed
- CL11, Closer installed in wrong location

Door Operators

- DO1, Missing door operator
- DO2, Incorrect door operator
- DO3, Does not close door completely
- DO4, Incorrect arm
- DO5, Door operator installed in wrong location
- DO6, Door operator not integrated with access control
- DO7, Door Operator not integrated with fire alarm
- DO8, Missing /defective/incorrect location(s) of actuator buttons

Stops & Holders

- ST1, Kick-down door holder installed
- ST2, Door stop with manual hold-open
- ST3, Door propped open
- ST4, Door stop missing
- ST5, Door stop incorrectly installed
- ST6, Door stop damaged
- ST7, Door stop fasteners stripped, missing or broken
- ST8, Electromagnetic holder not functioning correctly
- ST9, Electromagnetic holder damaged
- ST10, Electromagnetic holder fasteners stripped, missing or broken

Accessories

- TH1, Threshold missing/damaged/installed incorrectly
- TH2, Incorrect threshold
- TH3, Threshold fasteners stripped, missing or broken
- GA1, Gasketing/smoke seal missing/damaged/installed incorrectly
- GA2, Incorrect gasketing/smoke seal installed
- GA3, Gasketing/smoke seal fasteners stripped, missing or broken
- GA4, Door sweep/bottom is missing/damaged
- GA5, Incorrect door sweep/bottom installed
- GA6, Door sweep/bottom fasteners stripped, missing or broken
- GA7, Astragal/meeting stile(s) missing/damaged
- GA8, Incorrect astragal/meeting stile(s)
- GA9, Astragals/meeting stile(s) fasteners stripped, missing or broken
- MI1, Signage too large
- MI2, Signage screwed/nailed to door
- MI3, Door viewer missing/damaged/incorrect

Electronic Accessories & Controls

- EA1, Missing/defective/incorrect
- EA2, Not connected/commissioned
- EA3, Incorrect system operation

Other

- OT-x, Reference Opening Detail page

Building: SNF

Non-Compliant
Level: 417

Mark: 417-101A

Secure Side

Description: 3' 0" x 6' 8" x 1 3/4" WD.G Wood HM.3F.M Hollow Metal FR-20

Issue Codes: D9

Hardware Set #: 56.38M.69.7.KP.WP

Qty	Type	Description	Part Description
3	Hinge		Full Mortise - Standard - 4-1/2"x4-1/2" - Ball Bearing
1	Lockset		Mortise - Non-Electrified - CLASSROOM SECURITY
1	Closer		Surface - Push Side - Track
1	Plate		Plates - Kick Plate
1	Plate		Wrap around

Non-Secure Side

Opening Remarks:
Issue Comments:

D9: Improper field modification or repair
 Comments:
 Corrective Action: Replace
 Issue Status: Non-Compliant



O1



O2



O4



O3



D9-1

Building: SNF

Non-Compliant
Level: 417

Mark: 417-101E

Secure Side

Description: 3' 0" x 6' 8" x 1 3/4" HM.G Hollow Metal HM.3F.M Hollow Metal FR-20

Issue Codes: **D2, D3, D4, F4**
Hardware Set #: 56.38M.69.7.KP.

Qty	Type	Description	Part Description
3	Hinge		Full Mortise - Standard - 4-1/2"x4-1/2" - Ball Bearing
1	Lockset		Mortise - Non-Electrified - CLASSROOM SECURITY
1	Closer		Surface - Push Side - Track
1	Plate		Plates - Kick Plate

Non-Secure Side

Opening Remarks:
Issue Comments:

- D2: Door damaged (bent, dented, delaminating)
Comments:
Corrective Action: Replace
Issue Status: Non-Compliant
- D3: Missing/painted/illegible label
Comments: Painted
Issue Status: Non-Compliant
- D4: Incorrect/missing/broken glass
Comments: Non-rated glass
Issue Status: Non-Compliant
- F4: Missing/painted/illegible label
Comments: Painted
Issue Status: Non-Compliant



02



01



03



04



05



D2-1

Building: SNF

Non-Compliant
Level: 417

Mark: 417-102

Secure Side

Description: 2' 6" x 6' 8" x 1 3/4" WD.F Wood HM.TR.M Hollow Metal FR-60

Issue Codes: D2, F4

Hardware Set #: 56.38M.50.4(4x4).

Qty	Type	Description	Part Description
3	Hinge		Full Mortise - Standard - 4"x4"
1	Lockset		Mortise - Non-Electrified - CLASSROOM SECURITY

Non-Secure Side

Opening Remarks:
Issue Comments:

D2: Door damaged (bent, dented, delaminating)

Comments:

Corrective Action: Replace

Issue Status: Non-Compliant

F4: Missing/painted/illegible label

Comments: Missing

Issue Status: Non-Compliant

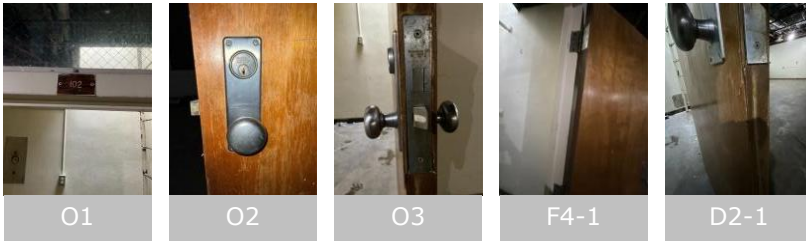

Building: SNF

Non-Compliant

Level: 417

Mark: 417-104A

Secure Side

Description: 3' 0" x 6' 8" x 1 3/4" WD.G Wood HM.3F.D Hollow Metal FR-20



Issue Codes: D9

Hardware Set #: 56.04M.69.7.WP

Qty	Type	Description	Part Description
3	Hinge		Full Mortise - Standard - 4-1/2"x4-1/2" - Ball Bearing
1	Lockset		Mortise - Non-Electrified - Store (F07) - Escutcheon - Knob
1	Closer		Surface - Push Side - Track
1	Plate		Wrap around

Non-Secure Side



Opening Remarks:

Issue Comments:

D9: Improper field modification or repair
 Comments:
 Corrective Action: Replace
 Issue Status: Non-Compliant

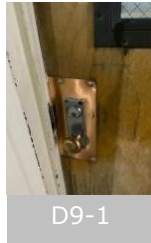

Building: SNF

Non-Compliant
Level: 417

Mark: 417-107A

Secure Side

Description: 3' 6" x 6' 8" x 1 3/4" WD.G Wood HM.3F.M Hollow Metal FR-20

Issue Codes: D2, D9

Hardware Set #: 56.38M.69.7.KP.WP

Qty	Type	Description	Part Description
3	Hinge		Full Mortise - Standard - 4-1/2"x4-1/2" - Ball Bearing
1	Lockset		Mortise - Non-Electrified - CLASSROOM SECURITY
1	Closer		Surface - Push Side - Track
1	Plate		Plates - Kick Plate
1	Plate		Wrap around

Non-Secure Side

Opening Remarks:
Issue Comments:

D2: Door damaged (bent, dented, delaminating)

Comments:

Issue Status: Non-Compliant

D9: Improper field modification or repair

Comments:

Issue Status: Non-Compliant

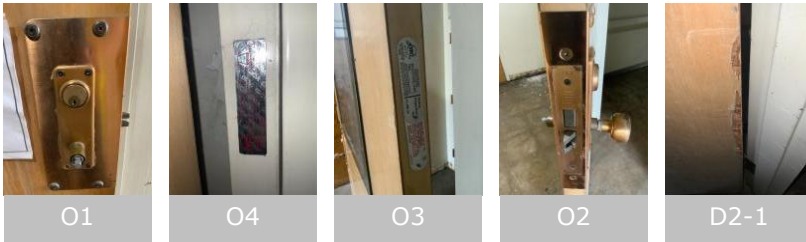

Building: SNF

Non-Compliant
Level: 417

Mark: 417-108

Secure Side

Description: 3' 0" x 6' 8" x 1 3/4" HM.F Hollow Metal HM.3F.M Hollow Metal FR-20

Issue Codes: **D3, F4**
Hardware Set #: 26.38M.69.7.SW.

Qty	Type	Description	Part Description
3	Hinge		Full Mortise - Standard - 4-1/2"x4-1/2" - Ball Bearing
1	Lockset		Mortise - Non-Electrified - CLASSROOM SECURITY
1	Closer		Surface - Push Side - Track
1	Sweep		Brush

Non-Secure Side

Opening Remarks:
Issue Comments:

D3: Missing/painted/illegible label
 Comments: Painted
 Issue Status: Non-Compliant

F4: Missing/painted/illegible label
 Comments: Painted
 Issue Status: Non-Compliant



Building: SNF

Non-Compliant
Level: 417

Mark: 417-112

Secure Side

Description: 3' 8" x 6' 8" x 1 3/4" WD.F Wood HM.3F.M Hollow Metal FR-20

Issue Codes: **D9**
Hardware Set #: 55.95HL/03.69.5.KP.WP

Qty	Type	Description	Part Description
3	Hinge		Full Mortise - Standard - 5"x4-1/2" - Ball Bearing
1	Lockset		Cylindrical - Non-Electrified - Passage (F75) - Hospital Latch
1	Lockset		Deadbolt - Mortise - Small Body Deadbolt - Double Cylinder
1	Closer		Surface - Push Side - Track
1	Plate		Plates - Kick Plate
1	Plate		Wrap around

Non-Secure Side

Opening Remarks:
Issue Comments:

D9: Improper field modification or repair
 Comments:
 Corrective Action: Replace
 Issue Status: Non-Compliant



Building: SNF

Non-Compliant
Level: 417

Mark: 417-113

Secure Side

Description: 3' 0" x 6' 8" x 1 3/4" WD.F Wood HM.3F.M Hollow Metal FR-20

Issue Codes: **D9**
Hardware Set #: 56.38M.69.7.WP

Qty	Type	Description	Part Description
3	Hinge		Full Mortise - Standard - 4-1/2"x4-1/2" - Ball Bearing
1	Lockset		Mortise - Non-Electrified - CLASSROOM SECURITY
1	Closer		Surface - Push Side - Track
1	Plate		Wrap around

Non-Secure Side

Opening Remarks:
Issue Comments:

D9: Improper field modification or repair
 Comments:
 Corrective Action: Replace
 Issue Status: Non-Compliant



O2



O1



O3



O4



O5



D9-1

Building: SNF

Non-Compliant
Level: 417

Mark: 417-114

Secure Side

Description: 3' 0" x 6' 8" x 1 3/4" WD.F Wood HM.3F.M Hollow Metal FR-20

Issue Codes: **D9**
Hardware Set #: 56.04M.69.5.KP.WP

Qty	Type	Description	Part Description
3	Hinge		Full Mortise - Standard - 5"x4-1/2" - Ball Bearing
1	Lockset		Mortise - Non-Electrified - Store (F07) - Escutcheon - Knob
1	Closer		Surface - Push Side - Track
1	Plate		Plates - Kick Plate
1	Plate		Wrap around

Non-Secure Side

Opening Remarks:
Issue Comments:

D9: Improper field modification or repair
 Comments:
 Corrective Action: Replace
 Issue Status: Non-Compliant



Building: SNF

Non-Compliant
Level: 417

Mark: 417-115

Secure Side

Description: 3' 8" x 6' 8" x 1 3/4" WD.F Wood HM.3F.M Hollow Metal FR-20

Issue Codes: F4

Hardware Set #: 55.95HL/03.69.5.KP.WP.MHO

Qty	Type	Description	Part Description
3	Hinge		Full Mortise - Standard - 5"x4-1/2" - Ball Bearing
1	Lockset		Cylindrical - Non-Electrified - Passage (F75) - Hospital Latch
1	Lockset		Deadbolt - Mortise - Small Body Deadbolt - Double Cylinder
1	Mag Hold Open		Surface - Medium Duty (Traffic) - Model
1	Closer		Surface - Push Side - Track
1	Plate		Plates - Kick Plate
1	Plate		Wrap around

Non-Secure Side

Opening Remarks:
Issue Comments:

 F4: Missing/painted/illegible label
 Comments: Missing
 Issue Status: Non-Compliant

Building: SNF

Non-Compliant
Level: 417

Mark: 417-116

Secure Side

Description: 3' 8" x 6' 8" x 1 3/4" WD.F Wood HM.3F.M Hollow Metal FR-20

Issue Codes: **D9, F4**
Hardware Set #: 55.95HL/03.69.5.KP.WP.MHO

Qty	Type	Description	Part Description
3	Hinge		Full Mortise - Standard - 5"x4-1/2" - Ball Bearing
1	Lockset		Cylindrical - Non-Electrified - Passage (F75) - Hospital Latch
1	Lockset		Deadbolt - Mortise - Small Body Deadbolt - Double Cylinder
1	Mag Hold Open		Surface - Medium Duty (Traffic) - Model
1	Closer		Surface - Push Side - Track
1	Plate		Plates - Kick Plate
1	Plate		Wrap around

Non-Secure Side

Opening Remarks:
Issue Comments:

D9: Improper field modification or repair
 Comments:
 Corrective Action: Replace
 Issue Status: Non-Compliant

F4: Missing/painted/illegible label
 Comments: Missing
 Issue Status: Non-Compliant

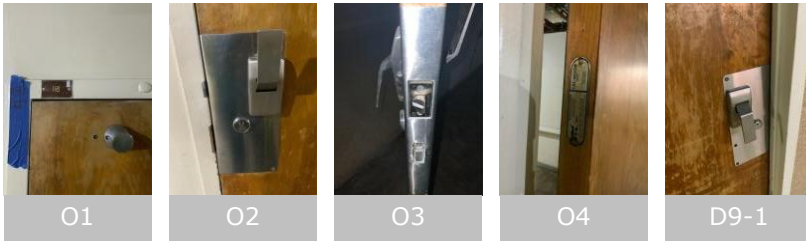

Building: SNF

Non-Compliant
Level: 417

Mark: 417-117

Secure Side

Description: 3' 8" x 6' 8" x 1 3/4" WD.F Wood HM.3F.M Hollow Metal FR-20

Issue Codes: **D9, F4**
Hardware Set #: 55.95HL/03.69.5.KP.WP.MHO

Qty	Type	Description	Part Description
3	Hinge		Full Mortise - Standard - 5"x4-1/2" - Ball Bearing
1	Lockset		Cylindrical - Non-Electrified - Passage (F75) - Hospital Latch
1	Lockset		Deadbolt - Mortise - Small Body Deadbolt - Double Cylinder
1	Mag Hold Open		Surface - Medium Duty (Traffic) - Model
1	Closer		Surface - Push Side - Track
1	Plate		Plates - Kick Plate
1	Plate		Wrap around

Non-Secure Side

Opening Remarks:
Issue Comments:

D9: Improper field modification or repair
 Comments:
 Corrective Action: Replace
 Issue Status: Non-Compliant

F4: Missing/painted/illegible label
 Comments: Missing
 Issue Status: Non-Compliant

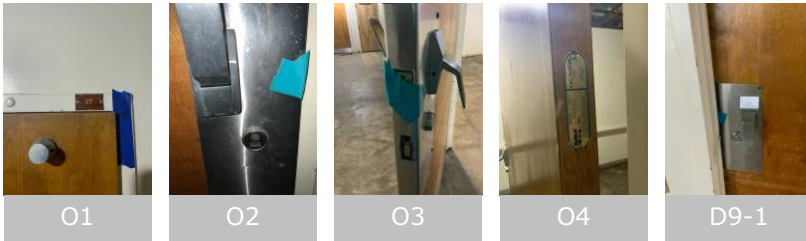

Building: SNF

Non-Compliant
Level: 417

Mark: 417-118

Secure Side

Description: 3' 8" x 6' 8" x 1 3/4" WD.F Wood HM.3F.M Hollow Metal FR-20

Issue Codes: **D9, F4**
Hardware Set #: 55.95HL/03.69.5.KP.WP.MHO

Qty	Type	Description	Part Description
3	Hinge		Full Mortise - Standard - 5"x4-1/2" - Ball Bearing
1	Lockset		Cylindrical - Non-Electrified - Passage (F75) - Hospital Latch
1	Lockset		Deadbolt - Mortise - Small Body Deadbolt - Double Cylinder
1	Mag Hold Open		Surface - Medium Duty (Traffic) - Model
1	Closer		Surface - Push Side - Track
1	Plate		Plates - Kick Plate
1	Plate		Wrap around

Non-Secure Side

Opening Remarks:
Issue Comments:

- D9: Improper field modification or repair
 Comments:
 Corrective Action: Replace
 Issue Status: Non-Compliant
- F4: Missing/painted/illegible label
 Comments: Missing
 Issue Status: Non-Compliant

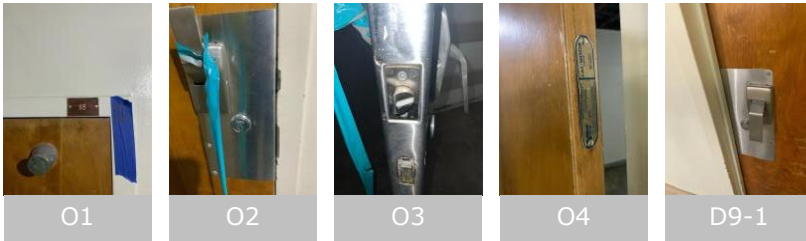

Building: SNF

Non-Compliant
Level: 417

Mark: 417-119

Secure Side

Description: 3' 0" x 6' 8" x 1 3/4" WD.F Wood HM.3F.M Hollow Metal FR-20

Issue Codes: **D2, D9**
Hardware Set #: 56.04M.69.7

Qty Type Description

- 3 Hinge
- 1 Lockset
- 1 Closer

Part Description

- Full Mortise - Standard - 4-1/2"x4-1/2"
- Ball Bearing
- Mortise - Non-Electrified - Store (F07) -
Escutcheon - Knob
- Surface - Push Side - Track

Non-Secure Side

Opening Remarks:
Issue Comments:

- D2: Door damaged (bent, dented, delaminating)
Comments:
Corrective Action: Replace
Issue Status: Non-Compliant
- D9: Improper field modification or repair
Comments:
Corrective Action: Replace
Issue Status: Non-Compliant



O1



O3



O2



D2-1



D9-1



D2-3



D2-2

Building: SNF

Non-Compliant
Level: 417

Mark: 417-120

Secure Side

Description: 3' 0" x 6' 8" x 1 3/4" WD.F Wood HM.3F.M Hollow Metal FR-60

Issue Codes: **D2, D9, F4**
Hardware Set #: 56.04M.69.7.KP.WP

Qty	Type	Description	Part Description
3	Hinge		Full Mortise - Standard - 4-1/2"x4-1/2" - Ball Bearing
1	Lockset		Mortise - Non-Electrified - Store (F07) - Escutcheon - Knob
1	Closer		Surface - Push Side - Track
1	Plate		Plates - Kick Plate
1	Plate		Wrap around

Non-Secure Side

Opening Remarks:
Issue Comments:

D2: Door damaged (bent, dented, delaminating)

Comments:

Corrective Action: Replace

Issue Status: Non-Compliant

D9: Improper field modification or repair

Comments:

Corrective Action: Replace

Issue Status: Non-Compliant

F4: Missing/painted/illegible label

Comments: Painted

Issue Status: Non-Compliant



O1



O4



O3



O2

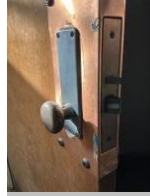

O5



D9-1



D2-1

Building: SNF

Non-Compliant
Level: 417

Mark: 417-121

Secure Side

Description: 3' 6" x 6' 8" x 1 3/4" WD.G Wood HM.3F.M Hollow Metal FR-20

Issue Codes: **D2, D9, F4**
Hardware Set #: 56.38M.69.7

Qty Type Description

3	Hinge
1	Lockset
1	Closer

Part Description

Full Mortise - Standard - 4-1/2"x4-1/2" - Ball Bearing
Mortise - Non-Electrified - CLASSROOM SECURITY
Surface - Push Side - Track

Non-Secure Side

Opening Remarks:
Issue Comments:

D2: Door damaged (bent, dented, delaminating)

Comments:

Corrective Action: Repair

Issue Status: Non-Compliant

D9: Improper field modification or repair

Comments:

Corrective Action: Replace

Issue Status: Non-Compliant

F4: Missing/painted/illegible label

Comments: Defaced

Issue Status: Non-Compliant



O1



O2



O3



O4



F4-1



D2-1



D9-1

Building: SNF

Non-Compliant
Level: 417

Mark: 417-122

Secure Side

Description: 2' 6" x 6' 8" x 1 3/4" WD.F Wood HM.3F.M Hollow Metal FR-20

Issue Codes: D2, D9

Hardware Set #: 56.04M.69.4(4")

Qty	Type	Description	Part Description
3	Hinge		Full Mortise - Standard - 4"x4"
1	Lockset		Mortise - Non-Electrified - Store (F07) - Escutcheon - Knob
1	Closer		Surface - Push Side - Track

Non-Secure Side

Opening Remarks:
Issue Comments:

D2: Door damaged (bent, dented, delaminating)

Comments:

Corrective Action: Replace

Issue Status: Non-Compliant

D9: Improper field modification or repair

Comments:

Corrective Action: Replace

Issue Status: Non-Compliant



O2



O1



O3



O5



O4



D9-1



D2-1

Building: SNF

Non-Compliant
Level: 417

Mark: 417-124

Secure Side

Description: 3' 8" x 6' 8" x 1 3/4" WD.F Wood HM.3F.M Hollow Metal FR-20

Issue Codes: **D2, D9, F4**
Hardware Set #: 55.95HL/03.69.5.KP.WP

Qty	Type	Description	Part Description
3	Hinge		Full Mortise - Standard - 5"x4-1/2" - Ball Bearing
1	Lockset		Cylindrical - Non-Electrified - Passage (F75) - Hospital Latch
1	Lockset		Deadbolt - Mortise - Small Body Deadbolt - Double Cylinder
1	Closer		Surface - Push Side - Track
1	Plate		Plates - Kick Plate
1	Plate		Wrap around

Non-Secure Side

Opening Remarks:
Issue Comments:

D2: Door damaged (bent, dented, delaminating)

Comments:

Corrective Action: Replace

Issue Status: Non-Compliant

D9: Improper field modification or repair

Comments:

Corrective Action: Replace

Issue Status: Non-Compliant

F4: Missing/painted/illegible label

Comments: Missing

Issue Status: Non-Compliant



O1



O2



O3



O4



D2-1



D9-1

Building: SNF

Non-Compliant
Level: 417

Mark: 417-125

Secure Side

Description: 3' 0" x 6' 8" x 1 3/4" WD.F Wood HM.3F.M Hollow Metal FR-20

Issue Codes: D2, D9

Hardware Set #: 55.95HL/03.69.5.KP.WP

Qty	Type	Description	Part Description
3	Hinge		Full Mortise - Standard - 5"x4-1/2" - Ball Bearing
1	Lockset		Cylindrical - Non-Electrified - Passage (F75) - Hospital Latch
1	Lockset		Deadbolt - Mortise - Small Body Deadbolt - Double Cylinder
1	Closer		Surface - Push Side - Track
1	Plate		Plates - Kick Plate
1	Plate		Wrap around

Non-Secure Side

Opening Remarks:
Issue Comments:

D2: Door damaged (bent, dented, delaminating)

Comments:

Corrective Action: Replace

Issue Status: Non-Compliant

D9: Improper field modification or repair

Comments:

Issue Status: Non-Compliant



01



02



03



04



05



D9-1



D2-1

Building: SNF

Non-Compliant
Level: 417

Mark: 417-126

Secure Side

Description: 3' 0" x 6' 8" x 1 3/4" WD.F Wood HM.3F.M Hollow Metal FR-20

Issue Codes: **D9, F4, O2**
Hardware Set #: 56.04M.69.7.KP.WP

Qty	Type	Description	Part Description
3	Hinge		Full Mortise - Standard - 4-1/2"x4-1/2" - Ball Bearing
1	Lockset		Mortise - Non-Electrified - Store (F07) - Escutcheon - Knob
1	Closer		Surface - Push Side - Track
1	Plate		Plates - Kick Plate
1	Plate		Wrap around

Non-Secure Side

Opening Remarks:
Issue Comments:

D9: Improper field modification or repair

Comments:

Corrective Action: Replace

Issue Status: Non-Compliant

F4: Missing/painted/illegible label

Comments: Painted

Issue Status: Non-Compliant

O2: Door does not close completely

Comments: Wrap around plate prevent door from closing completely

Issue Status: Non-Compliant



01



02



03



04



05



D9-1

Building: SNF

Non-Compliant
Level: 417

Mark: 417-127

Secure Side

Description: 3' 8" x 6' 8" x 1 3/4" WD.F Wood HM.3F.M Hollow Metal FR-20

Issue Codes: D2, D9, F4

Hardware Set #: 55.95HL/03.69.5.KP.WP

Qty	Type	Description	Part Description
3	Hinge		Full Mortise - Standard - 5"x4-1/2" - Ball Bearing
1	Lockset		Cylindrical - Non-Electrified - Passage (F75) - Hospital Latch
1	Lockset		Deadbolt - Mortise - Small Body Deadbolt - Double Cylinder
1	Closer		Surface - Push Side - Track
1	Plate		Plates - Kick Plate
1	Plate		Wrap around

Non-Secure Side

Opening Remarks:
Issue Comments:

D2: Door damaged (bent, dented, delaminating)

Comments:

Corrective Action: Replace

Issue Status: Non-Compliant

D9: Improper field modification or repair

Comments:

Corrective Action: Replace

Issue Status: Non-Compliant

F4: Missing/painted/illegible label

Comments: Missing

Issue Status: Non-Compliant



01



02



03



D2-1



D9-1

Building: SNF

Non-Compliant
Level: 419

Mark: 419-129

Secure Side

Description: 3' 8" x 6' 8" x 1 3/4" WD.F Wood HM.3F.M Hollow Metal FR-20

Issue Codes: D9, F4

Hardware Set #: 55.95HL.69.5.KP.WP.MHO

Qty	Type	Description	Part Description
3	Hinge		Full Mortise - Standard - 5"x4-1/2" - Ball Bearing
1	Lockset		Cylindrical - Non-Electrified - Passage (F75) - Hospital Latch
1	Mag Hold Open		Surface - Medium Duty (Traffic) - Model
1	Closer		Surface - Push Side - Track
1	Plate		Plates - Kick Plate
1	Plate		Wrap around

Non-Secure Side

Opening Remarks:
Issue Comments:

D9: Improper field modification or repair
 Comments:
 Corrective Action: Replace
 Issue Status: Non-Compliant

F4: Missing/painted/illegible label
 Comments: Missing
 Issue Status: Non-Compliant



Building: SNF

Non-Compliant
Level: 417

Mark: 417-131A

Secure Side

Description: 4' 0" x 6' 8" x 1 3/4" HM.G Hollow Metal HM.3F.M Hollow Metal FR-20

Issue Codes: **D2, D9**
Hardware Set #: 56.38M.69.7.WP

Qty	Type	Description	Part Description
3	Hinge		Full Mortise - Standard - 4-1/2"x4-1/2" - Ball Bearing
1	Lockset		Mortise - Non-Electrified - CLASSROOM SECURITY
1	Closer		Surface - Push Side - Track
1	Plate		Wrap around

Non-Secure Side

Opening Remarks:
Issue Comments:

D2: Door damaged (bent, dented, delaminating)

Comments:

Corrective Action: Replace

Issue Status: Non-Compliant

D9: Improper field modification or repair

Comments:

Issue Status: Non-Compliant



O1



O2



O3



O4



D2-1



D9-1

Building: SNF

Non-Compliant
Level: 417

Mark: 417-133

Secure Side

Description: 3' 8" x 6' 8" x 1 3/4" WD.F Wood HM.3F.M Hollow Metal FR-20

Issue Codes: **D2, D9, F4**
Hardware Set #: 55.95HL/03.69.5.KP.WP

Qty	Type	Description	Part Description
3	Hinge		Full Mortise - Standard - 5"x4-1/2" - Ball Bearing
1	Lockset		Cylindrical - Non-Electrified - Passage (F75) - Hospital Latch
1	Lockset		Deadbolt - Mortise - Small Body Deadbolt - Double Cylinder
1	Closer		Surface - Push Side - Track
1	Plate		Plates - Kick Plate
1	Plate		Wrap around

Non-Secure Side

Opening Remarks:
Issue Comments:

D2: Door damaged (bent, dented, delaminating)

Comments:

Corrective Action: Replace

Issue Status: Non-Compliant

D9: Improper field modification or repair

Comments:

Corrective Action: Replace

Issue Status: Non-Compliant

F4: Missing/painted/illegible label

Comments: Missing

Issue Status: Non-Compliant



O1



O2



O3



O4



D9-1



D2-1

Building: SNF

Non-Compliant
Level: 417

Mark: 417-135

Secure Side

Description: 3' 8" x 6' 8" x 1 3/4" WD.F Wood HM.3F.M Hollow Metal FR-20

Issue Codes: **D2, D9, F4**
Hardware Set #: 55.95HL/03.69.5.KP.WP

Qty	Type	Description	Part Description
3	Hinge		Full Mortise - Standard - 5"x4-1/2" - Ball Bearing
1	Lockset		Cylindrical - Non-Electrified - Passage (F75) - Hospital Latch
1	Lockset		Deadbolt - Mortise - Small Body Deadbolt - Double Cylinder
1	Closer		Surface - Push Side - Track
1	Plate		Plates - Kick Plate
1	Plate		Wrap around

Non-Secure Side

Opening Remarks:
Issue Comments:

D2: Door damaged (bent, dented, delaminating)

Comments:

Corrective Action: Replace

Issue Status: Non-Compliant

D9: Improper field modification or repair

Comments:

Issue Status: Non-Compliant

F4: Missing/painted/illegible label

Comments: Missing

Issue Status: Non-Compliant

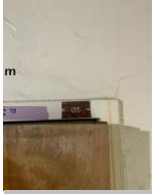

O1



O2



O3



O4



D2-1



D2-2



D9-1

Building: SNF

Non-Compliant
Level: 417

Mark: 417-136

Secure Side

Description: 3' 8" x 6' 8" x 1 3/4" WD.F Wood HM.3F.M Hollow Metal FR-20

Issue Codes: D2, D9, F4

Hardware Set #: 55.95HL/03.69.5.KP.WP.MHO

Qty	Type	Description	Part Description
3	Hinge		Full Mortise - Standard - 5"x4-1/2" - Ball Bearing
1	Lockset		Cylindrical - Non-Electrified - Passage (F75) - Hospital Latch
1	Lockset		Deadbolt - Mortise - Small Body Deadbolt - Double Cylinder
1	Mag Hold Open		Surface - Medium Duty (Traffic) - Model
1	Closer		Surface - Push Side - Track
1	Plate		Plates - Kick Plate
1	Plate		Wrap around

Non-Secure Side

Opening Remarks:
Issue Comments:

D2: Door damaged (bent, dented, delaminating)

Comments:

Corrective Action: Replace

Issue Status: Non-Compliant

D9: Improper field modification or repair

Comments:

Issue Status: Non-Compliant

F4: Missing/painted/illegible label

Comments: Missing

Issue Status: Non-Compliant

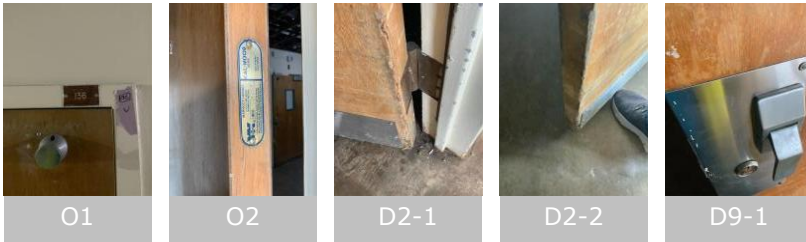

Building: SNF

Non-Compliant
Level: 417

Mark: 417-137

Secure Side

Description: 3' 0" x 6' 8" x 1 3/4" WD.F Wood HM.3F.M Hollow Metal FR-20

Issue Codes: **D2, D9, F4**
Hardware Set #: 56.04M.69.7.WP

Qty	Type	Description	Part Description
3	Hinge		Full Mortise - Standard - 4-1/2"x4-1/2" - Ball Bearing
1	Lockset		Mortise - Non-Electrified - Store (F07) - Escutcheon - Knob
1	Closer		Surface - Push Side - Track
1	Plate		Wrap around

Non-Secure Side

Opening Remarks:
Issue Comments:

D2: Door damaged (bent, dented, delaminating)

Comments:

Issue Status: Non-Compliant

D9: Improper field modification or repair

Comments:

Corrective Action: Replace

Issue Status: Non-Compliant

F4: Missing/painted/illegible label

Comments: Painted

Issue Status: Non-Compliant



O1



O2



O3



O4



D9-1



D2-1

Building: SNF

Non-Compliant
Level: 417

Mark: 417-139

Secure Side

Description: 3' 8" x 6' 8" x 1 3/4" WD.F Wood HM.3F.M Hollow Metal FR-20

Issue Codes: **D2, D9, F4**
Hardware Set #: 55.95HL/03.69.5.KP.WP

Qty	Type	Description	Part Description
3	Hinge		Full Mortise - Standard - 5"x4-1/2" - Ball Bearing
1	Lockset		Cylindrical - Non-Electrified - Passage (F75) - Hospital Latch
1	Lockset		Deadbolt - Mortise - Small Body Deadbolt - Double Cylinder
1	Closer		Surface - Push Side - Track
1	Plate		Plates - Kick Plate
1	Plate		Wrap around

Non-Secure Side

Opening Remarks:
Issue Comments:

D2: Door damaged (bent, dented, delaminating)

Comments:

Corrective Action: Replace

Issue Status: Non-Compliant

D9: Improper field modification or repair

Comments:

Issue Status: Non-Compliant

F4: Missing/painted/illegible label

Comments: Missing

Issue Status: Non-Compliant



O1



O2



O3



O4



D2-1



D2-2



D9-1

Building: SNF

Non-Compliant
Level: 417

Mark: 417-141

Secure Side

Description: 3' 0" x 6' 8" x 1 3/4" WD.F Wood HM.3F.M Hollow Metal FR-20

Issue Codes: **D2**
Hardware Set #: 56.04M.69.7.WP

Qty	Type	Description	Part Description
3	Hinge		Full Mortise - Standard - 4-1/2"x4-1/2" - Ball Bearing
1	Lockset		Mortise - Non-Electrified - Store (F07) - Escutcheon - Knob
1	Closer		Surface - Push Side - Track
1	Plate		Wrap around

Non-Secure Side

Opening Remarks:
Issue Comments:

D2: Door damaged (bent, dented, delaminating)
 Comments:
 Corrective Action: Replace
 Issue Status: Non-Compliant



Building: SNF

Non-Compliant
Level: 417

Mark: 417-142

Secure Side

Description: 3' 0" x 6' 8" x 1 3/4" HM.DD Hollow Metal HM.3F.M Hollow Metal FR-20

Issue Codes: **F4**
Hardware Set #: 56.04M/04C.69.7.MHO

Qty	Type	Description	Part Description
3	Hinge		Full Mortise - Standard - 4-1/2"x4-1/2" - Ball Bearing
1	Lockset		Mortise - Non-Electrified - Store (F07) - Escutcheon - Knob
1	Lockset		Cylindrical - Non-Electrified - Store (F86) - Knob
1	Mag Hold Open		Surface - Medium Duty (Traffic) - Model
1	Closer		Surface - Push Side - Track

Non-Secure Side

Opening Remarks:
Issue Comments:

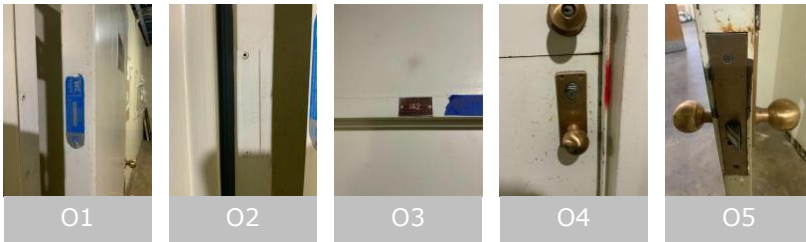
 F4: Missing/painted/illegible label
 Comments: Painted
 Issue Status: Non-Compliant

Building: SNF

Non-Compliant
Level: 417

Mark: 417-145

Secure Side

Description: 3' 0" x 6' 8" x 1 3/4" WD.F Wood HM.3F.M Hollow Metal FR-20

Issue Codes: **D2, D9, F4**
Hardware Set #: 56.04M.69.7.KP.WP

Qty	Type	Description	Part Description
3	Hinge		Full Mortise - Standard - 4-1/2"x4-1/2" - Ball Bearing
1	Lockset		Mortise - Non-Electrified - Store (F07) - Escutcheon - Knob
1	Closer		Surface - Push Side - Track
1	Plate		Plates - Kick Plate
1	Plate		Wrap around

Non-Secure Side

Opening Remarks:
Issue Comments:

D2: Door damaged (bent, dented, delaminating)

Comments:

Corrective Action: Replace

Issue Status: Non-Compliant

D9: Improper field modification or repair

Comments:

Issue Status: Non-Compliant

F4: Missing/painted/illegible label

Comments: Painted

Issue Status: Non-Compliant



O1



O2



O3



O4



O5



D2-1



D9-1

Building: SNF

Non-Compliant
Level: 417

Mark: 417-146

Secure Side

Description: 3' 0" x 6' 8" x 1 3/4" WD.F Wood HM.TR.M Hollow Metal FR-20

Issue Codes: **D2, D9, F4**
Hardware Set #: 56.04M.69.7.KP.WP

Qty	Type	Description	Part Description
3	Hinge		Full Mortise - Standard - 4-1/2"x4-1/2" - Ball Bearing
1	Lockset		Mortise - Non-Electrified - Store (F07) - Escutcheon - Knob
1	Closer		Surface - Push Side - Track
1	Plate		Plates - Kick Plate
1	Plate		Wrap around

Non-Secure Side

Opening Remarks:
Issue Comments:

D2: Door damaged (bent, dented, delaminating)

Comments:

Corrective Action: Replace

Issue Status: Non-Compliant

D9: Improper field modification or repair

Comments:

Corrective Action: Replace

Issue Status: Non-Compliant

F4: Missing/painted/illegible label

Comments: Missing

Issue Status: Non-Compliant



O2



O1



O4



O3



D9-1



D2-1

Building: SNF

Non-Compliant
Level: 417

Mark: 417-147

Secure Side

Description: 2' 6" x 6' 8" x 1 3/4" WD.F Wood HM.TR.M Hollow Metal FR-60

Issue Codes: **D2**
Hardware Set #: 56.04M.69.4(4").KP

Qty	Type	Description	Part Description
3	Hinge		Full Mortise - Standard - 4"x4"
1	Lockset		Mortise - Non-Electrified - Store (F07) - Escutcheon - Knob
1	Closer		Surface - Push Side - Track
1	Plate		Plates - Kick Plate

Non-Secure Side

Opening Remarks:
Issue Comments:

D2: Door damaged (bent, dented, delaminating)

Comments:

Corrective Action: Replace

Issue Status: Non-Compliant



O1



D2-1



D2-2

Building: SNF

Non-Compliant
Level: 417

Mark: 417-148

Secure Side

Description: 4' 0" x 6' 8" x 1 3/4" WD.F Wood HM.3F.M Hollow Metal FR-20

Issue Codes: **D2, F4, O5**
Hardware Set #: 56.04M.41.4(4").AF.KP.AS

Qty	Type	Description	Part Description
6	Hinge		Full Mortise - Standard - 4"x4"
1	Bolt		Concealed - Automatic
1	Lockset		Mortise - Non-Electrified - Store (F07) - Escutcheon - Knob
2	Closer		Surface - Push Side - Parallel
2	Plate		Plates - Kick Plate
1	Astragal		Flat Astragal - Steel

Non-Secure Side

Opening Remarks:
Issue Comments:

D2: Door damaged (bent, dented, delaminating)

Comments: Both doors

Corrective Action: Replace

Issue Status: Non-Compliant

F4: Missing/painted/illegible label

Comments: Missing

Issue Status: Non-Compliant

O5: Door drags on floor, rubs frame/rubs other door

Comments: Top of door, rubs top of frame at strike side on an active door

Issue Status: Non-Compliant



O1



O2



O3



O4



O5



D2-1



D2-2



D2-4



D2-3

Building: SNF

Non-Compliant
Level: 417

Mark: 417-150

Secure Side

Description: 3' 8" x 6' 8" x 1 3/4" WD.TYPE 4 Wood HM.3F.M Hollow Metal FR-20

Issue Codes: **D2, D9, F2, F4**
Hardware Set #: 56.05M.69.5.KP.WP.MHO

Qty	Type	Description	Part Description
3	Hinge		Full Mortise - Standard - 5"x4-1/2" - Ball Bearing
1	Lockset		Mortise - Non-Electrified - Ent/Off (F04) - Escutcheon - Knob
1	Mag Hold Open		Surface - Medium Duty (Traffic) - Model
1	Closer		Surface - Push Side - Track
1	Plate		Plates - Kick Plate
1	Plate		Wrap around

Non-Secure Side

Opening Remarks:
Issue Comments:

D2: Door damaged (bent, dented, delaminating)

Comments:

Issue Status: Non-Compliant

D9: Improper field modification or repair

Comments:

Issue Status: Non-Compliant

F2: Damaged/rust through on frame

Comments:

Corrective Action: Replace

Issue Status: Non-Compliant

F4: Missing/painted/illegible label

Comments: Missing

Issue Status: Non-Compliant

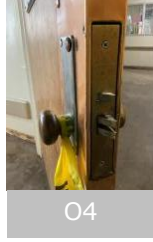
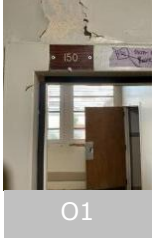

Building: SNF

Non-Compliant
Level: 417

Mark: 417-151

Secure Side

Description: 3' 8" x 6' 8" x 1 3/4" WD.TYPE 4 Wood HM.3F.M Hollow Metal FR-20

Issue Codes: **D2, D9, F4**
Hardware Set #: 56.05M.69.5.KP.WP.MHO

Qty	Type	Description	Part Description
3	Hinge		Full Mortise - Standard - 5"x4-1/2" - Ball Bearing
1	Lockset		Mortise - Non-Electrified - Ent/Off (F04) - Escutcheon - Knob
1	Mag Hold Open		Surface - Medium Duty (Traffic) - Model
1	Closer		Surface - Push Side - Track
1	Plate		Plates - Kick Plate
1	Plate		Wrap around

Non-Secure Side

Opening Remarks:
Issue Comments:

- D2: Door damaged (bent, dented, delaminating)
 Comments: Damaged and warped
 Corrective Action: Replace
 Issue Status: Non-Compliant
- D9: Improper field modification or repair
 Comments:
 Issue Status: Non-Compliant
- F4: Missing/painted/illegible label
 Comments: Missing
 Issue Status: Non-Compliant



O1



O2



O3



O4



D9-1



D2-1



D2-3



D2-2

Building: SNF

Non-Compliant
Level: 417

Mark: 417-152

Secure Side

Description: 3' 8" x 6' 8" x 1 3/4" WD.TYPE 4 Wood HM.3F.M Hollow Metal FR-20

Issue Codes: **D2, D9, F4, O5**
Hardware Set #: 55.95HL/03.69.5.KP.WP.MHO(1)

Qty	Type	Description	Part Description
3	Hinge		Full Mortise - Standard - 5"x4-1/2" - Ball Bearing
1	Lockset		Cylindrical - Non-Electrified - Passage (F75) - Hospital Latch
1	Lockset		Deadbolt - Mortise - Small Body Deadbolt - Double Cylinder
1	Mag Hold Open		Surface - Medium Duty (Traffic) - Model
1	Closer		Surface - Push Side - Track
2	Plate		Plates - Kick Plate
1	Plate		Wrap around

Non-Secure Side

Opening Remarks:
Issue Comments:

D2: Door damaged (bent, dented, delaminating)

Comments:

Corrective Action: Replace

Issue Status: Non-Compliant

D9: Improper field modification or repair

Comments:

Issue Status: Non-Compliant

F4: Missing/painted/illegible label

Comments: Missing

Issue Status: Non-Compliant

O5: Door drags on floor, rubs frame/rubs other door

Comments: Wrap plate rubs on frame.

Issue Status: Non-Compliant



O1



O2



O3



O4



D2-1



D2-2



D9-1

Building: SNF

Non-Compliant
Level: 417

Mark: 417-153

Secure Side

Description: 3' 0" x 6' 8" x 1 3/4" WD.F Wood HM.3F.M Hollow Metal FR-20

Issue Codes: D2, D9, F4

Hardware Set #: 55.95HL/03.69.5.KP.WP.MHO

Qty	Type	Description	Part Description
3	Hinge		Full Mortise - Standard - 5"x4-1/2" - Ball Bearing
1	Lockset		Cylindrical - Non-Electrified - Passage (F75) - Hospital Latch
1	Lockset		Deadbolt - Mortise - Small Body Deadbolt - Double Cylinder
1	Mag Hold Open		Surface - Medium Duty (Traffic) - Model
1	Closer		Surface - Push Side - Track
1	Plate		Plates - Kick Plate
1	Plate		Wrap around

Non-Secure Side

Opening Remarks:
Issue Comments:

D2: Door damaged (bent, dented, delaminating)

Comments:

Corrective Action: Replace

Issue Status: Non-Compliant

D9: Improper field modification or repair

Comments:

Corrective Action: Replace

Issue Status: Non-Compliant

F4: Missing/painted/illegible label

Comments: Missing

Issue Status: Non-Compliant



O1



O2



O3



O4



D2-1



D9-1

Building: SNF

Non-Compliant
Level: 417

Mark: 417-155

Secure Side

Description: 3' 8" x 6' 8" x 1 3/4" WD.F Wood HM.3F.M Hollow Metal FR-20

Issue Codes: **D2, D9, F4**
Hardware Set #: 55.95HL/03.69.5.KP.WP.MHO

Qty	Type	Description	Part Description
3	Hinge		Full Mortise - Standard - 5"x4-1/2" - Ball Bearing
1	Lockset		Cylindrical - Non-Electrified - Passage (F75) - Hospital Latch
1	Lockset		Deadbolt - Mortise - Small Body Deadbolt - Double Cylinder
1	Mag Hold Open		Surface - Medium Duty (Traffic) - Model
1	Closer		Surface - Push Side - Track
1	Plate		Plates - Kick Plate
1	Plate		Wrap around

Non-Secure Side

Opening Remarks:
Issue Comments:

D2: Door damaged (bent, dented, delaminating)

Comments:

Corrective Action: Replace

Issue Status: Non-Compliant

D9: Improper field modification or repair

Comments:

Issue Status: Non-Compliant

F4: Missing/painted/illegible label

Comments: Missing

Issue Status: Non-Compliant



O1



O2



O3



O4



D2-1



D9-1

Building: SNF

Non-Compliant
Level: 417

Mark: 417-156

Secure Side

Description: 3' 0" x 6' 8" x 1 3/4" WD.F Wood HM.3F.M Hollow Metal FR-20

Issue Codes: **D2, D9, F4**
Hardware Set #: 56.04M.69.7.KP.WP

Qty	Type	Description	Part Description
3	Hinge		Full Mortise - Standard - 4-1/2"x4-1/2" - Ball Bearing
1	Lockset		Mortise - Non-Electrified - Store (F07) - Escutcheon - Knob
1	Closer		Surface - Push Side - Track
1	Plate		Plates - Kick Plate
1	Plate		Wrap around

Non-Secure Side

Opening Remarks:
Issue Comments:

D2: Door damaged (bent, dented, delaminating)

Comments:

Issue Status: Non-Compliant

D9: Improper field modification or repair

Comments:

Corrective Action: Replace

Issue Status: Non-Compliant

F4: Missing/painted/illegible label

Comments: Painted

Issue Status: Non-Compliant



01



02



03



04



05

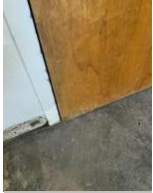

D2-1



D9-1

Building: SNF

Non-Compliant
Level: 417

Mark: 417-157

Secure Side

Description: 3' 0" x 6' 8" x 1 3/4" WD.F Wood HM.3F.M Hollow Metal FR-20

Issue Codes: D9, F4

Hardware Set #: 56.04M.69.7.KP.WP

Qty	Type	Description	Part Description
3	Hinge		Full Mortise - Standard - 4-1/2"x4-1/2" - Ball Bearing
1	Lockset		Mortise - Non-Electrified - Store (F07) - Escutcheon - Knob
1	Closer		Surface - Push Side - Track
1	Plate		Plates - Kick Plate
1	Plate		Wrap around

Non-Secure Side

Opening Remarks:
Issue Comments:

D9: Improper field modification or repair
 Comments:
 Corrective Action: Replace
 Issue Status: Non-Compliant

F4: Missing/painted/illegible label
 Comments: Painted
 Issue Status: Non-Compliant

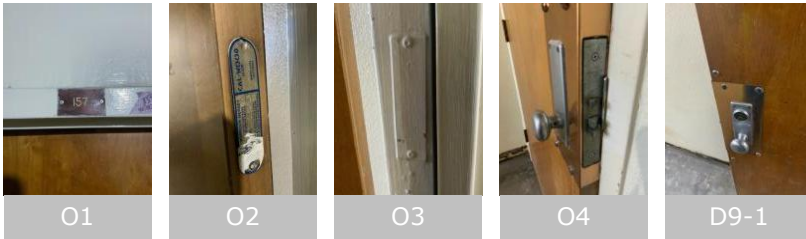

Building: SNF

Non-Compliant
Level: 417

Mark: 417-C100

Secure Side

Description: 7' 0" x 6' 8" x 1 3/4" HM.G Hollow Metal HM.3F.M Hollow Metal FR-20

Issue Codes: **D2, F4**
Hardware Set #: 45.10.69.5.T.SV.KP.EG.MHO

Qty	Type	Description	Part Description
6	Hinge		Full Mortise - Standard - 5"x4-1/2" - Ball Bearing
2	Exit Device		Surface Vertical Rod - Exit Only
2	Mag Hold Open		Surface - Medium Duty (Traffic) - Model
2	Closer		Surface - Push Side - Track
2	Plate		Plates - Kick Plate
2	Plate		Guards - Edge Guards
1	Threshold		Saddle

Non-Secure Side

Opening Remarks:
Issue Comments:

D2: Door damaged (bent, dented, delaminating)

Comments:

Issue Status: Non-Compliant

F4: Missing/painted/illegible label

Comments: Painted

Issue Status: Non-Compliant

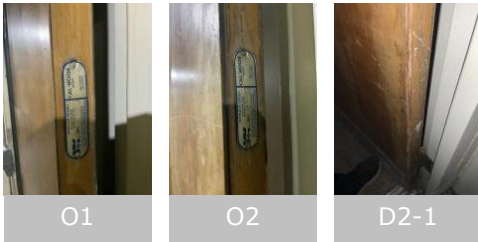

Building: SNF

Non-Compliant

Level: 418

Mark: 418-101E

Secure Side

Description: 3' 0" x 6' 8" x 1 3/4" HM.G Hollow Metal HM.3F.M Hollow Metal FR-20



Issue Codes: D2

Hardware Set #: 56.38M.69.7.KP.(1)

Qty	Type	Description	Part Description
3	Hinge		Full Mortise - Standard - 4-1/2"x4-1/2" - Ball Bearing
1	Lockset		Mortise - Non-Electrified - CLASSROOM SECURITY
1	Closer		Surface - Push Side - Track
2	Plate		Plates - Kick Plate

Non-Secure Side



Opening Remarks:

Issue Comments:

D2: Door damaged (bent, dented, delaminating)
 Comments: Door split
 Corrective Action: Replace
 Issue Status: Non-Compliant



Building: SNF

Non-Compliant
Level: 418

Mark: 418-102

Secure Side

Description: 2' 6" x 6' 8" x 1 3/4" WD.F Wood HM.TR.M Hollow Metal FR-60

Issue Codes: **D2, F2, F3, F4, O5**
Hardware Set #: 56.04M.50.4(4x4).

Qty	Type	Description	Part Description
3	Hinge		Full Mortise - Standard - 4"x4"
1	Lockset		Mortise - Non-Electrified - Store (F07) - Escutcheon - Knob

Non-Secure Side

Opening Remarks:
Issue Comments:

- D2: Door damaged (bent, dented, delaminating)
 Comments:
 Corrective Action: Replace
 Issue Status: Non-Compliant
- F2: Damaged/rust through on frame
 Comments: Both legs
 Issue Status: Non-Compliant
- F3: Frame is out of alignment
 Comments:
 Issue Status: Non-Compliant
- F4: Missing/painted/illegible label
 Comments: Missing
 Issue Status: Non-Compliant
- O5: Door drags on floor, rubs frame/rubs other door
 Comments: Top of door rubs top of frame.
 Issue Status: Non-Compliant

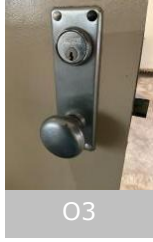

Building: SNF

Non-Compliant
Level: 418

Mark: 418-104A

Secure Side

Description: 3' 0" x 6' 8" x 1 3/4" HM.G Hollow Metal HM.TR.SL-H Hollow Metal FR-20

Issue Codes: **D2**
Hardware Set #: 56.04M.69.7.AP

Qty Type Description

- 3 Hinge
- 1 Lockset
- 1 Closer
- 1 Plate

Part Description

- Full Mortise - Standard - 4-1/2"x4-1/2" - Ball Bearing
- Mortise - Non-Electrified - Store (F07) - Escutcheon - Knob
- Surface - Push Side - Track
- Plates - Armor Plate

Non-Secure Side

Opening Remarks:
Issue Comments:

D2: Door damaged (bent, dented, delaminating)
 Comments:
 Corrective Action: Replace
 Issue Status: Non-Compliant



Building: SNF

Non-Compliant

Level: 418

Mark: 418-104B

Secure Side

Description: 3' 0" x 6' 8" x 1 3/4" WD.G Wood HM.TR.SL-H Hollow Metal FR-20



Issue Codes: **D2, F4**

Hardware Set #: 56.04M.69.7

Qty Type Description

- 3 Hinge
- 1 Lockset
- 1 Closer

Part Description

- Full Mortise - Standard - 4-1/2"x4-1/2" - Ball Bearing
- Mortise - Non-Electrified - Store (F07) - Escutcheon - Knob
- Surface - Push Side - Track

Non-Secure Side



Opening Remarks:

Issue Comments:

D2: Door damaged (bent, dented, delaminating)

Comments:

Issue Status: Non-Compliant

F4: Missing/painted/illegible label

Comments:

Issue Status: Non-Compliant



Building: SNF

Non-Compliant
Level: 418

Mark: 418-108

Secure Side

Description: 3' 0" x 6' 8" x 1 3/4" HM.F Hollow Metal HM.3F.M Hollow Metal FR-90

Issue Codes: **D2**
Hardware Set #: 26.04M.69.7.SW.

Qty	Type	Description	Part Description
3	Hinge		Full Mortise - Standard - 4-1/2"x4-1/2" - Ball Bearing
1	Lockset		Mortise - Non-Electrified - Store (F07) - Escutcheon - Knob
1	Closer		Surface - Push Side - Track
1	Sweep		Brush

Non-Secure Side

Opening Remarks:
Issue Comments:

D2: Door damaged (bent, dented, delaminating)
 Comments:
 Corrective Action: Replace
 Issue Status: Non-Compliant

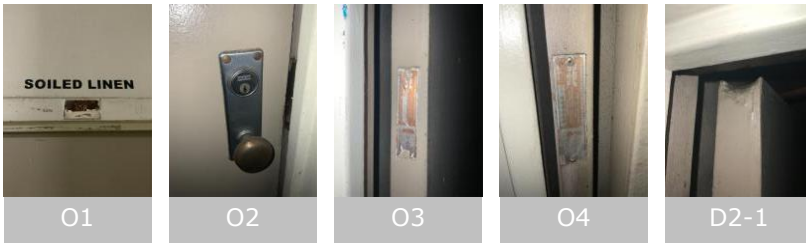

Building: SNF

Non-Compliant
Level: 418

Mark: 418-109

Secure Side

Description: 4' 8" x 6' 8" x 1 3/4" WD.F Wood HM.3F.M Hollow Metal FR-20

Issue Codes: **D2**
Hardware Set #: 56.04M.69.7.MF.AS

Qty	Type	Description	Part Description
6	Hinge		Full Mortise - Standard - 4-1/2"x4-1/2" - Ball Bearing
1	Bolt		Concealed - Lever Extension
1	Lockset		Mortise - Non-Electrified - Store (F07) - Escutcheon - Knob
2	Closer		Surface - Push Side - Track
1	Astragal		Flat Astragal - Aluminum - Brush

Non-Secure Side

Opening Remarks:
Issue Comments:

D2: Door damaged (bent, dented, delaminating)
 Comments:
 Corrective Action: Replace
 Issue Status: Non-Compliant



Building: SNF

Non-Compliant
Level: 418

Mark: 418-110

Secure Side

Description: 2' 6" x 6' 8" x 1 3/4" WD.F Wood HM.3F.M Hollow Metal FR-20

Issue Codes: **D2**
Hardware Set #: 56.04M.69.4(4")

Qty	Type	Description	Part Description
3	Hinge		Full Mortise - Standard - 4"x4"
1	Lockset		Mortise - Non-Electrified - Store (F07) - Escutcheon - Knob
1	Closer		Surface - Push Side - Track

Non-Secure Side

Opening Remarks:
Issue Comments:

D2: Door damaged (bent, dented, delaminating)
 Comments:
 Corrective Action: Replace
 Issue Status: Non-Compliant



Building: SNF

Non-Compliant
Level: 418

Mark: 418-111

Secure Side

Description: 3' 0" x 6' 8" x 1 3/4" WD.F Wood HM.TR.M Hollow Metal FR-20

Issue Codes: **D2**
Hardware Set #: 56.04M.69.5.

Qty Type Description

- 3 Hinge
- 1 Lockset
- 1 Closer

Part Description

- Full Mortise - Standard - 5"x4-1/2" - Ball Bearing
- Mortise - Non-Electrified - Store (F07) - Escutcheon - Knob
- Surface - Push Side - Track

Non-Secure Side

Opening Remarks:
Issue Comments:

D2: Door damaged (bent, dented, delaminating)

Comments:

Corrective Action: Replace

Issue Status: Non-Compliant



O1



O2



O3



O4



D2-1



D2-2

Building: SNF

Non-Compliant
Level: 418

Mark: 418-112

Secure Side

Description: 3' 8" x 6' 8" x 1 3/4" WD.F Wood HM.3F.M Hollow Metal FR-20

Issue Codes: D9

Hardware Set #: 55.95HL/03.69.5.KP.WP

Qty	Type	Description	Part Description
3	Hinge		Full Mortise - Standard - 5"x4-1/2" - Ball Bearing
1	Lockset		Cylindrical - Non-Electrified - Passage (F75) - Hospital Latch
1	Lockset		Deadbolt - Mortise - Small Body Deadbolt - Double Cylinder
1	Closer		Surface - Push Side - Track
1	Plate		Plates - Kick Plate
1	Plate		Wrap around

Non-Secure Side

Opening Remarks:
Issue Comments:

D9: Improper field modification or repair
 Comments:
 Corrective Action: Replace
 Issue Status: Non-Compliant



Building: SNF

Non-Compliant

Level: 418

Mark: 418-113

Secure Side

Description: 3' 0" x 6' 8" x 1 3/4" WD.F Wood HM.3F.M Hollow Metal FR-20



Issue Codes: D2

Hardware Set #: 56.04M.69.7

Qty Type Description

- 3 Hinge
- 1 Lockset
- 1 Closer

Part Description

- Full Mortise - Standard - 4-1/2"x4-1/2" - Ball Bearing
- Mortise - Non-Electrified - Store (F07) - Escutcheon - Knob
- Surface - Push Side - Track

Non-Secure Side



Opening Remarks:

Issue Comments:

D2: Door damaged (bent, dented, delaminating)
 Comments:
 Corrective Action: Replace
 Issue Status: Non-Compliant



Building: SNF

Compliant

Level: 418

Mark: 418-114

Secure Side

Description: 3' 0" x 6' 8" x 1 3/4" WD.F Wood HM.3F.M Hollow Metal FR-20



Hardware Set #: 56.04M.69.7

Qty Type Description

- 3 Hinge
- 1 Lockset
- 1 Closer

Part Description

- Full Mortise - Standard - 4-1/2"x4-1/2" - Ball Bearing
- Mortise - Non-Electrified - Store (F07) - Escutcheon - Knob
- Surface - Push Side - Track

Non-Secure Side



Opening Remarks:

Issue Comments:

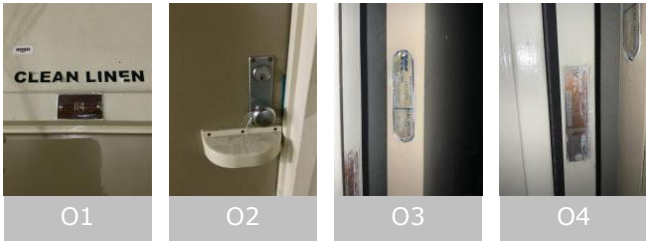

Building: SNF

Non-Compliant
Level: 418

Mark: 418-115

Secure Side

Description: 3' 8" x 6' 8" x 1 3/4" WD.F Wood HM.3F.M Hollow Metal FR-20

Issue Codes: D9

Hardware Set #: 55.95HL.69.5.KP.WP(5)

Qty	Type	Description	Part Description
3	Hinge		Full Mortise - Standard - 5"x4-1/2" - Ball Bearing
1	Lockset		Cylindrical - Non-Electrified - Passage (F75) - Hospital Latch
1	Closer		Surface - Push Side - Track
1	Plate		Plates - Kick Plate
1	Plate		Wrap around

Non-Secure Side

Opening Remarks:
Issue Comments:

D9: Improper field modification or repair
 Comments:
 Corrective Action: Replace
 Issue Status: Non-Compliant



Building: SNF

Non-Compliant
Level: 418

Mark: 418-116

Secure Side

Description: 3' 8" x 6' 8" x 1 3/4" WD.F Wood HM.3F.M Hollow Metal FR-20

Issue Codes: D9

Hardware Set #: 56.04M.69.5.WP.MHO

Qty	Type	Description	Part Description
3	Hinge		Full Mortise - Standard - 5"x4-1/2" - Ball Bearing
1	Lockset		Mortise - Non-Electrified - Store (F07) - Escutcheon - Knob
1	Mag Hold Open		Surface - Medium Duty (Traffic) - Model
1	Closer		Surface - Push Side - Track
1	Plate		Wrap around

Non-Secure Side

Opening Remarks:
Issue Comments:

D9: Improper field modification or repair
 Comments:
 Corrective Action: Replace
 Issue Status: Non-Compliant



Building: SNF

Non-Compliant
Level: 418

Mark: 418-117

Secure Side

Description: 3' 8" x 6' 8" x 1 3/4" WD.F Wood HM.3F.M Hollow Metal FR-20

Issue Codes: D9

Hardware Set #: 55.95HL.69.5.KP.WP.MHO

Qty	Type	Description	Part Description
3	Hinge		Full Mortise - Standard - 5"x4-1/2" - Ball Bearing
1	Lockset		Cylindrical - Non-Electrified - Passage (F75) - Hospital Latch
1	Mag Hold Open		Surface - Medium Duty (Traffic) - Model
1	Closer		Surface - Push Side - Track
1	Plate		Plates - Kick Plate
1	Plate		Wrap around

Non-Secure Side

Opening Remarks:
Issue Comments:

D9: Improper field modification or repair
 Comments:
 Corrective Action: Replace
 Issue Status: Non-Compliant



O1



O2



O3



O4



D9-1

Building: SNF

Non-Compliant
Level: 418

Mark: 418-118

Secure Side

Description: 3' 8" x 6' 8" x 1 3/4" WD.F Wood HM.3F.M Hollow Metal FR-20

Issue Codes: D9, O5

Hardware Set #: 55.95HL.69.5.KP.WP.MHO

Qty	Type	Description	Part Description
3	Hinge		Full Mortise - Standard - 5"x4-1/2" - Ball Bearing
1	Lockset		Cylindrical - Non-Electrified - Passage (F75) - Hospital Latch
1	Mag Hold Open		Surface - Medium Duty (Traffic) - Model
1	Closer		Surface - Push Side - Track
1	Plate		Plates - Kick Plate
1	Plate		Wrap around

Non-Secure Side

Opening Remarks:
Issue Comments:

D9: Improper field modification or repair

Comments:

Corrective Action: Replace

Issue Status: Non-Compliant

O5: Door drags on floor, rubs frame/rubs other door

Comments: Rubs on frame

Issue Status: Non-Compliant



Building: SNF

Non-Compliant
Level: 418

Mark: 418-121

Secure Side

Description: 3' 0" x 6' 8" x 1 3/4" WD.F Wood HM.3F.M Hollow Metal FR-20

Issue Codes: D9

Hardware Set #: 56.04M.69.7.WP

Qty	Type	Description	Part Description
3	Hinge		Full Mortise - Standard - 4-1/2"x4-1/2" - Ball Bearing
1	Lockset		Mortise - Non-Electrified - Store (F07) - Escutcheon - Knob
1	Closer		Surface - Push Side - Track
1	Plate		Wrap around

Non-Secure Side

Opening Remarks:
Issue Comments:

D9: Improper field modification or repair
 Comments:
 Corrective Action: Replace
 Issue Status: Non-Compliant

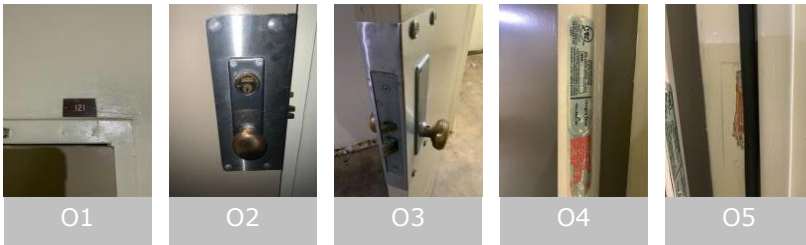

Building: SNF

Non-Compliant
Level: 418

Mark: 418-122

Secure Side

Description: 2' 6" x 6' 8" x 1 3/4" WD.F Wood HM.3F.M Hollow Metal FR-20

Issue Codes: D2

Hardware Set #: 56.04M.69.4(4")

Qty	Type	Description	Part Description
3	Hinge		Full Mortise - Standard - 4"x4"
1	Lockset		Mortise - Non-Electrified - Store (F07) - Escutcheon - Knob
1	Closer		Surface - Push Side - Track

Non-Secure Side

Opening Remarks:
Issue Comments:

D2: Door damaged (bent, dented, delaminating)
 Comments:
 Corrective Action: Replace
 Issue Status: Non-Compliant



Building: SNF

Non-Compliant
Level: 420

Mark: 418-123

Secure Side

Description: 3' 0" x 6' 8" x 1 3/4" HM.F Hollow Metal HM.3F.M Hollow Metal FR-90

Issue Codes: **D2, O5**
Hardware Set #: 26.38M.69.4(4").SW.

Qty	Type	Description	Part Description
3	Hinge		Full Mortise - Standard - 4"x4"
1	Lockset		Mortise - Non-Electrified - CLASSROOM SECURITY
1	Closer		Surface - Push Side - Track
1	Sweep		Brush

Non-Secure Side

Opening Remarks:
Issue Comments:

- D2: Door damaged (bent, dented, delaminating)
 Comments: Dented
 Issue Status: Non-Compliant
- O5: Door drags on floor, rubs frame/rubs other door
 Comments: Door rubs on frame at bottom strike side
 Issue Status: Non-Compliant



Building: SNF

Non-Compliant
Level: 418

Mark: 418-125

Secure Side

Description: 3' 0" x 6' 8" x 1 3/4" WD.F Wood HM.3F.M Hollow Metal FR-20

Issue Codes: D2, D9

Hardware Set #: 55.95HL.69.5.KP.WP(2)

Qty	Type	Description	Part Description
3	Hinge		Full Mortise - Standard - 5"x4-1/2" - Ball Bearing
1	Lockset		Cylindrical - Non-Electrified - Passage (F75) - Hospital Latch
1	Closer		Surface - Push Side - Track
1	Plate		Plates - Kick Plate
1	Plate		Wrap around

Non-Secure Side

Opening Remarks:
Issue Comments:

D2: Door damaged (bent, dented, delaminating)

Comments:

Corrective Action: Replace

Issue Status: Non-Compliant

D9: Improper field modification or repair

Comments:

Issue Status: Non-Compliant



O1



O2



O3



O4



D2-1



D2-2



D9-1

Building: SNF

Non-Compliant
Level: 418

Mark: 418-126

Secure Side

Description: 3' 0" x 6' 8" x 1 3/4" WD.F Wood HM.3F.M Hollow Metal FR-20

Issue Codes: D2

Hardware Set #: 56.04M.69.5.

Qty Type Description

- 3 Hinge
- 1 Lockset
- 1 Closer

Part Description

- Full Mortise - Standard - 5"x4-1/2" - Ball Bearing
- Mortise - Non-Electrified - Store (F07) - Escutcheon - Knob
- Surface - Push Side - Track

Non-Secure Side

Opening Remarks:
Issue Comments:

D2: Door damaged (bent, dented, delaminating)
 Comments:
 Corrective Action: Replace
 Issue Status: Non-Compliant



Building: SNF

Non-Compliant
Level: 418

Mark: 418-128

Secure Side

Description: 3' 8" x 6' 8" x 1 3/4" WD.F Wood HM.3F.M Hollow Metal FR-20

Issue Codes: **D2, D9, F4**
Hardware Set #: 55.95HL.69.5.KP.WP(3)

Qty	Type	Description	Part Description
3	Hinge		Full Mortise - Standard - 5"x4-1/2" - Ball Bearing
1	Lockset		Cylindrical - Non-Electrified - Passage (F75) - Hospital Latch
1	Closer		Surface - Push Side - Track
1	Plate		Plates - Kick Plate
1	Plate		Wrap around

Non-Secure Side

Opening Remarks:
Issue Comments:

D2: Door damaged (bent, dented, delaminating)

Comments:

Corrective Action: Replace

Issue Status: Non-Compliant

D9: Improper field modification or repair

Comments:

Issue Status: Non-Compliant

F4: Missing/painted/illegible label

Comments: Label has been removed

Issue Status: Non-Compliant



O1



O2



O3



O4



O5



F4-1



D9-1



D2-1

Building: SNF

Non-Compliant
Level: 418

Mark: 418-129

Secure Side

Description: 3' 8" x 6' 8" x 1 3/4" WD.F Wood HM.3F.M Hollow Metal FR-20

Issue Codes: **D2**
Hardware Set #: 55.95HL.69.5.KP.WP(6)

Qty	Type	Description	Part Description
3	Hinge		Full Mortise - Standard - 5"x4-1/2" - Ball Bearing
1	Lockset		Cylindrical - Non-Electrified - Passage (F75) - Hospital Latch
1	Closer		Surface - Push Side - Track
1	Plate		Plates - Kick Plate
1	Plate		Wrap around

Non-Secure Side



Opening Remarks:
Issue Comments:

D2: Door damaged (bent, dented, delaminating)

Comments:

Corrective Action: Replace

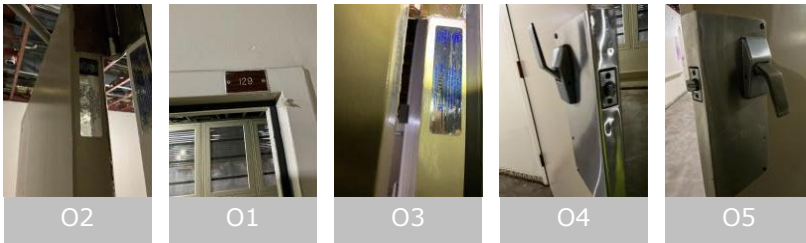
Issue Status: Non-Compliant



Building: SNF

Non-Compliant
Level: 418

Mark: 418-130

Secure Side

Description: 3' 8" x 6' 8" x 1 3/4" WD.F Wood HM.3F.M Hollow Metal FR-20

Issue Codes: **D2, F4, O5**
Hardware Set #: 55.95HL.69.5.KP.WP(4)

Qty	Type	Description	Part Description
3	Hinge		Full Mortise - Standard - 5"x4-1/2" - Ball Bearing
1	Lockset		Cylindrical - Non-Electrified - Passage (F75) - Hospital Latch
1	Closer		Surface - Push Side - Track
1	Plate		Plates - Kick Plate
1	Plate		Wrap around

Non-Secure Side

Opening Remarks:
Issue Comments:

D2: Door damaged (bent, dented, delaminating)

Comments:

Corrective Action: Replace

Issue Status: Non-Compliant

F4: Missing/painted/illegible label

Comments: Illegible

Issue Status: Non-Compliant

O5: Door drags on floor, rubs frame/rubs other door

Comments: Wrap plate rubs on frame

Issue Status: Non-Compliant



O1



O2



O3



O4



O5



D2-1



D2-2

Building: SNF

Non-Compliant
Level: 418

Mark: 418-132

Secure Side

Description: 2' 6" x 6' 8" x 1 3/4" WD.F Wood HM.3F.M Hollow Metal FR-20

Issue Codes: **D2**
Hardware Set #: 56.04M.69.7

Qty Type Description

- 3 Hinge
- 1 Lockset
- 1 Closer

Part Description

- Full Mortise - Standard - 4-1/2"x4-1/2"
- Ball Bearing
- Mortise - Non-Electrified - Store (F07) -
Escutcheon - Knob
- Surface - Push Side - Track

Non-Secure Side

Opening Remarks:
Issue Comments:

D2: Door damaged (bent, dented, delaminating)
 Comments:
 Corrective Action: Replace
 Issue Status: Non-Compliant

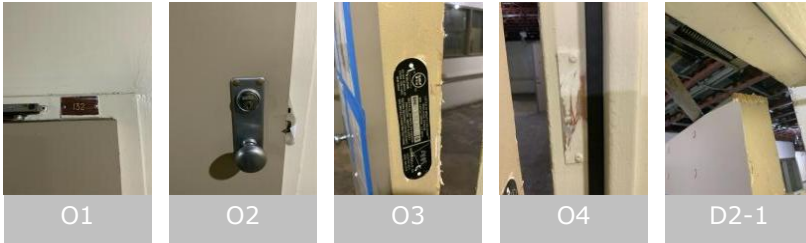

Building: SNF

Non-Compliant
Level: 418

Mark: 418-133

Secure Side

Description: 3' 8" x 6' 8" x 1 3/4" WD.F Wood HM.3F.M Hollow Metal FR-20

Issue Codes: **D2, D9, F4**
Hardware Set #: 55.95HL/03.69.5.KP.WP

Qty	Type	Description	Part Description
3	Hinge		Full Mortise - Standard - 5"x4-1/2" - Ball Bearing
1	Lockset		Cylindrical - Non-Electrified - Passage (F75) - Hospital Latch
1	Lockset		Deadbolt - Mortise - Small Body Deadbolt - Double Cylinder
1	Closer		Surface - Push Side - Track
1	Plate		Plates - Kick Plate
1	Plate		Wrap around

Non-Secure Side

Opening Remarks:
Issue Comments:

D2: Door damaged (bent, dented, delaminating)

Comments:

Corrective Action: Replace

Issue Status: Non-Compliant

D9: Improper field modification or repair

Comments:

Corrective Action: Replace

Issue Status: Non-Compliant

F4: Missing/painted/illegible label

Comments: Missing

Issue Status: Non-Compliant



O1



O2



O3



O4



D9-1



D2-1

Building: SNF

Non-Compliant
Level: 418

Mark: 418-134

Secure Side

Description: 3' 0" x 6' 8" x 1 3/4" WD.F Wood HM.3F.M Hollow Metal FR-20

Issue Codes: D2

Hardware Set #: 56.38M/03C.69.7

Qty	Type	Description	Part Description
3	Hinge		Full Mortise - Standard - 4-1/2"x4-1/2" - Ball Bearing
1	Lockset		Mortise - Non-Electrified - CLASSROOM SECURITY
1	Lockset		Deadbolt - Cylindrical - Cylinder x thumbturn
1	Closer		Surface - Push Side - Track
1	Plate		Plates - Kick Plate

Non-Secure Side

Opening Remarks:
Issue Comments:

D2: Door damaged (bent, dented, delaminating)

Comments:

Corrective Action: Replace

Issue Status: Non-Compliant



O1

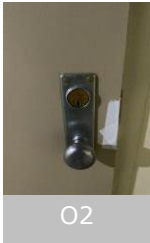

O2



O3



O4



D2-2



D2-1

Building: SNF

Non-Compliant
Level: 418

Mark: 418-135

Secure Side

Description: 3' 8" x 6' 8" x 1 3/4" WD.F Wood HM.3F.M Hollow Metal FR-20

Issue Codes: D9

Hardware Set #: 55.95HL/03.69.5.KP.WP.MHO

Qty	Type	Description	Part Description
3	Hinge		Full Mortise - Standard - 5"x4-1/2" - Ball Bearing
1	Lockset		Cylindrical - Non-Electrified - Passage (F75) - Hospital Latch
1	Lockset		Deadbolt - Mortise - Small Body Deadbolt - Double Cylinder
1	Mag Hold Open		Surface - Medium Duty (Traffic) - Model
1	Closer		Surface - Push Side - Track
1	Plate		Plates - Kick Plate
1	Plate		Wrap around

Non-Secure Side

Opening Remarks:
Issue Comments:

D9: Improper field modification or repair
 Comments:
 Corrective Action: Replace
 Issue Status: Non-Compliant



Building: SNF

Non-Compliant
Level: 418

Mark: 418-136

Secure Side

Description: 3' 8" x 6' 8" x 1 3/4" WD.F Wood HM.3F.M Hollow Metal FR-20

Issue Codes: **D9**
Hardware Set #: 55.95HL.69.5.KP.WP.MHO

Qty	Type	Description	Part Description
3	Hinge		Full Mortise - Standard - 5"x4-1/2" - Ball Bearing
1	Lockset		Cylindrical - Non-Electrified - Passage (F75) - Hospital Latch
1	Mag Hold Open		Surface - Medium Duty (Traffic) - Model
1	Closer		Surface - Push Side - Track
1	Plate		Plates - Kick Plate
1	Plate		Wrap around

Non-Secure Side

Opening Remarks:
Issue Comments:

D9: Improper field modification or repair
 Comments:
 Corrective Action: Replace
 Issue Status: Non-Compliant

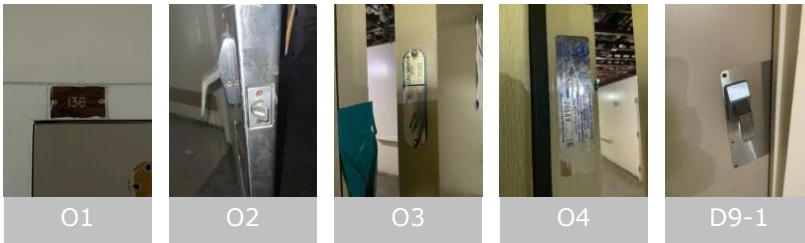

Building: SNF

Compliant

Level: 418

Mark: 418-137

Secure Side

Description: 3' 0" x 6' 8" x 1 3/4" WD.F Wood HM.3F.M Hollow Metal FR-20



Hardware Set #: 56.04M.69.7.

Qty Type Description

- 3 Hinge
- 1 Lockset
- 1 Closer

Part Description

- Full Mortise - Standard - 4-1/2"x4-1/2" - Ball Bearing
- Mortise - Non-Electrified - Store (F07) - Escutcheon - Knob
- Surface - Push Side - Track

Non-Secure Side



Opening Remarks:

Issue Comments:



O1



O2



O3



O4

Building: SNF

Non-Compliant
Level: 418

Mark: 418-139

Secure Side

Description: 3' 8" x 6' 8" x 1 3/4" WD.F Wood HM.3F.M Hollow Metal FR-20

Issue Codes: **D2, F4**
Hardware Set #: 55.95HL.69.5.WP

Qty	Type	Description	Part Description
3	Hinge		Full Mortise - Standard - 5"x4-1/2" - Ball Bearing
1	Lockset		Cylindrical - Non-Electrified - Passage (F75) - Hospital Latch
1	Closer		Surface - Push Side - Track
1	Plate		Wrap around

Non-Secure Side

Opening Remarks:
Issue Comments:

D2: Door damaged (bent, dented, delaminating)

Comments:

Corrective Action: Replace

Issue Status: Non-Compliant

F4: Missing/painted/illegible label

Comments: Missing

Issue Status: Non-Compliant



O1



O2



D2-1

Building: SNF

Non-Compliant
Level: 418

Mark: 418-140

Secure Side

Description: 3' 0" x 6' 8" x 1 3/4" WD.F Wood HM.3F.M Hollow Metal FR-20

Issue Codes: **D2**
Hardware Set #: 56.04M.69.7.KP

Qty	Type	Description	Part Description
3	Hinge		Full Mortise - Standard - 4-1/2"x4-1/2" - Ball Bearing
1	Lockset		Mortise - Non-Electrified - Store (F07) - Escutcheon - Knob
1	Closer		Surface - Push Side - Track
1	Plate		Plates - Kick Plate

Non-Secure Side

Opening Remarks:
Issue Comments:

D2: Door damaged (bent, dented, delaminating)
 Comments:
 Corrective Action: Replace
 Issue Status: Non-Compliant



Building: SNF

Non-Compliant
Level: 418

Mark: 418-141

Secure Side

Description: 3' 0" x 6' 8" x 1 3/4" WD.F Wood HM.3F.M Hollow Metal FR-20

Issue Codes: D2

Hardware Set #: 56.04M.69.7.KP

Qty Type Description

- 3 Hinge
- 1 Lockset
- 1 Closer
- 1 Plate

Part Description

- Full Mortise - Standard - 4-1/2"x4-1/2" - Ball Bearing
- Mortise - Non-Electrified - Store (F07) - Escutcheon - Knob
- Surface - Push Side - Track
- Plates - Kick Plate

Non-Secure Side

Opening Remarks:
Issue Comments:

D2: Door damaged (bent, dented, delaminating)
 Comments:
 Corrective Action: Replace
 Issue Status: Non-Compliant



Building: SNF

Compliant
Level: 418

Mark: 418-142

Secure Side

Description: 3' 0" x 6' 8" x 1 3/4" HM.DD Hollow Metal HM.3F.M Hollow Metal FR-20

Hardware Set #: 56.04M/04C.69.7.MHO

Qty	Type	Description	Part Description
3	Hinge		Full Mortise - Standard - 4-1/2"x4-1/2" - Ball Bearing
1	Lockset		Mortise - Non-Electrified - Store (F07) - Escutcheon - Knob
1	Lockset		Cylindrical - Non-Electrified - Store (F86) - Knob
1	Mag Hold Open		Surface - Medium Duty (Traffic) - Model
1	Closer		Surface - Push Side - Track

Non-Secure Side

Opening Remarks:
Issue Comments:

O1

O2

Building: SNF

Compliant

Level: 418

Mark: 418-143

Secure Side

Description: 3' 0" x 6' 8" x 1 3/4" WD.F Wood HM.3F.M Hollow Metal FR-20



Hardware Set #: 56.38M/03C.69.7.KP

Qty	Type	Description	Part Description
3	Hinge		Full Mortise - Standard - 4-1/2"x4-1/2" - Ball Bearing
1	Lockset		Mortise - Non-Electrified - CLASSROOM SECURITY
1	Lockset		Deadbolt - Cylindrical - Cylinder x thumbturn
1	Closer		Surface - Push Side - Track
1	Plate		Plates - Kick Plate

Non-Secure Side



Opening Remarks:

Issue Comments:

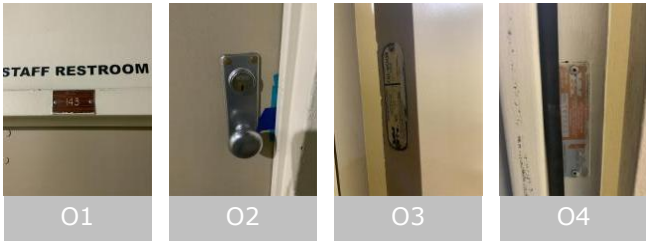

Building: SNF

Non-Compliant
Level: 418

Mark: 418-144

Secure Side

Description: 3' 0" x 6' 8" x 1 3/4" WD.F Wood HM.3F.M Hollow Metal FR-20

Issue Codes: **D9, F4**
Hardware Set #: 56.38M.50.7.WP

Qty Type Description

3 Hinge

1 Lockset

1 Plate

Part Description

 Full Mortise - Standard - 4-1/2"x4-1/2"
- Ball Bearing

 Mortise - Non-Electrified - CLASSROOM
SECURITY

Wrap around

Non-Secure Side

Opening Remarks:
Issue Comments:

D9: Improper field modification or repair

Comments:

Corrective Action: Replace

Issue Status: Non-Compliant

F4: Missing/painted/illegible label

Comments: Painted

Issue Status: Non-Compliant



O1



O2



O3



O4



D9-1

Building: SNF

Non-Compliant
Level: 418

Mark: 418-145

Secure Side

Description: 3' 0" x 6' 8" x 1 3/4" WD.F Wood HM.3F.M Hollow Metal FR-20

Issue Codes: D2

Hardware Set #: 56.04M.69.7.KP

Qty Type Description

- 3 Hinge
- 1 Lockset
- 1 Closer
- 1 Plate

Part Description

- Full Mortise - Standard - 4-1/2"x4-1/2" - Ball Bearing
- Mortise - Non-Electrified - Store (F07) - Escutcheon - Knob
- Surface - Push Side - Track
- Plates - Kick Plate

Non-Secure Side

Opening Remarks:
Issue Comments:

D2: Door damaged (bent, dented, delaminating)
 Comments: Door split
 Issue Status: Non-Compliant

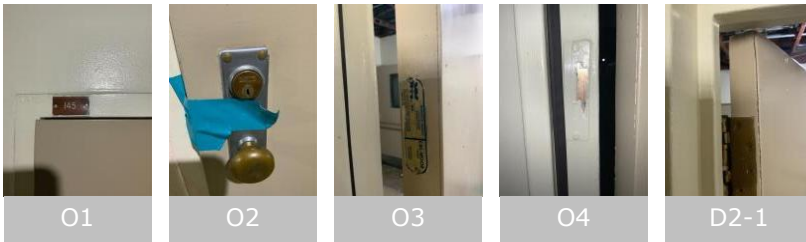

Building: SNF

Non-Compliant
Level: 418

Mark: 418-146

Secure Side

Description: 3' 0" x 6' 8" x 1 3/4" WD.F Wood HM.3F.M Hollow Metal FR-60

Issue Codes: D2, F2

Hardware Set #: 56.04M.69.4(4")

Qty	Type	Description	Part Description
3	Hinge		Full Mortise - Standard - 4"x4"
1	Lockset		Mortise - Non-Electrified - Store (F07) - Escutcheon - Knob
1	Closer		Surface - Push Side - Track

Non-Secure Side

Opening Remarks:
Issue Comments:

D2: Door damaged (bent, dented, delaminating)

Comments:

Corrective Action: Replace

Issue Status: Non-Compliant

F2: Damaged/rust through on frame

Comments:

Issue Status: Non-Compliant



O1



O2



D2-1



F2-1

Building: SNF

Non-Compliant
Level: 418

Mark: 418-147

Secure Side

Description: 2' 6" x 6' 8" x 1 3/4" WD.F Wood HM.TR.M Hollow Metal FR-20

Issue Codes: D9

Hardware Set #: 56.04M.69.4(4")(1)

Qty	Type	Description	Part Description
3	Hinge		Full Mortise - Standard - 4"x4"
1	Lockset		Mortise - Non-Electrified - Store (F07) - Escutcheon - Knob
1	Closer		Surface - Push Side - Track

Non-Secure Side

Opening Remarks:
Issue Comments:

D9: Improper field modification or repair
 Comments:
 Corrective Action: Replace
 Issue Status: Non-Compliant



Building: SNF

Non-Compliant
Level: 418

Mark: 418-148

Secure Side

Description: 4' 8" x 6' 8" x 1 3/4" WD.F Wood HM.3F.M Hollow Metal FR-20

Issue Codes: D2

Hardware Set #: 56.04M.69.4(4").MF.AS

Qty	Type	Description	Part Description
6	Hinge		Full Mortise - Standard - 4"x4"
1	Bolt		Concealed - Lever Extension
1	Lockset		Mortise - Non-Electrified - Store (F07) - Escutcheon - Knob
2	Closer		Surface - Push Side - Track
1	Astragal		Flat Astragal - Steel

Non-Secure Side

Opening Remarks:
Issue Comments:

D2: Door damaged (bent, dented, delaminating)
 Comments:
 Corrective Action: Replace
 Issue Status: Non-Compliant



Building: SNF

Non-Compliant
Level: 418

Mark: 418-149

Secure Side

Description: 3' 0" x 6' 8" x 1 3/4" WD.F Wood HM.3F.M Hollow Metal FR-20

Issue Codes: D9, F4

Hardware Set #: 55.95HL/03.50.7.WP

Qty	Type	Description	Part Description
3	Hinge		Full Mortise - Standard - 4-1/2"x4-1/2" - Ball Bearing
1	Lockset		Cylindrical - Non-Electrified - Passage (F75) - Hospital Latch
1	Lockset		Deadbolt - Mortise - Small Body Deadbolt - Double Cylinder
1	Plate		Wrap around

Non-Secure Side

Opening Remarks:
Issue Comments:

D9: Improper field modification or repair

Comments:

Corrective Action: Replace

Issue Status: Non-Compliant

F4: Missing/painted/illegible label

Comments: Missing

Issue Status: Non-Compliant



01



02



03



D9-1

Building: SNF

Non-Compliant
Level: 418

Mark: 418-150

Secure Side

Description: 3' 8" x 6' 8" x 1 3/4" WD.G Wood HM.3F.M Hollow Metal FR-20

Issue Codes: **D2**
Hardware Set #: 56.37M.69.5.

Qty Type Description

- 3 Hinge
- 1 Lockset
- 1 Closer

Part Description

- Full Mortise - Standard - 5"x4-1/2" - Ball Bearing
- Mortise - Non-Electrified - Class (F05) - Escutcheon - Knob - Thumbturn
- Surface - Push Side - Track

Non-Secure Side

Opening Remarks:
Issue Comments:

D2: Door damaged (bent, dented, delaminating)

Comments:

Corrective Action: Replace

Issue Status: Non-Compliant



O1



O2



O3



O4



O5



D2-1

Building: SNF

Non-Compliant
Level: 418

Mark: 418-151

Secure Side

Description: 3' 8" x 6' 8" x 1 3/4" WD.G Wood HM.3F.M Hollow Metal FR-20

Issue Codes: **D2**
Hardware Set #: 56.04M.69.5.

Qty Type Description

- 3 Hinge
- 1 Lockset
- 1 Closer

Part Description

- Full Mortise - Standard - 5"x4-1/2" - Ball Bearing
- Mortise - Non-Electrified - Store (F07) - Escutcheon - Knob
- Surface - Push Side - Track

Non-Secure Side

Opening Remarks:
Issue Comments:

D2: Door damaged (bent, dented, delaminating)
 Comments: Door split
 Issue Status: Non-Compliant

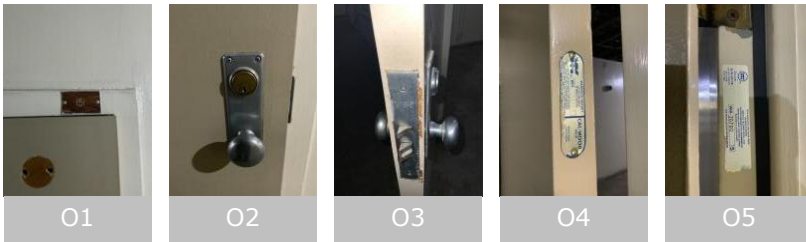

Building: SNF

Non-Compliant
Level: 418

Mark: 418-152

Secure Side

Description: 3' 8" x 6' 8" x 1 3/4" WD.G Wood HM.3F.M Hollow Metal FR-20

Issue Codes: D9

Hardware Set #: 55.95HL.69.5.WP.MHO

Qty	Type	Description	Part Description
3	Hinge		Full Mortise - Standard - 5"x4-1/2" - Ball Bearing
1	Lockset		Cylindrical - Non-Electrified - Passage (F75) - Hospital Latch
1	Mag Hold Open		Surface - Medium Duty (Traffic) - Model
1	Closer		Surface - Push Side - Track
1	Plate		Wrap around

Non-Secure Side

Opening Remarks:
Issue Comments:

D9: Improper field modification or repair
 Comments:
 Corrective Action: Replace
 Issue Status: Non-Compliant



Building: SNF

Non-Compliant
Level: 418

Mark: 418-153

Secure Side

Description: 3' 8" x 6' 8" x 1 3/4" WD.F Wood HM.3F.M Hollow Metal FR-20

Issue Codes: **D9**
Hardware Set #: 55.95HL.69.5.KP.WP.MHO

Qty	Type	Description	Part Description
3	Hinge		Full Mortise - Standard - 5"x4-1/2" - Ball Bearing
1	Lockset		Cylindrical - Non-Electrified - Passage (F75) - Hospital Latch
1	Mag Hold Open		Surface - Medium Duty (Traffic) - Model
1	Closer		Surface - Push Side - Track
1	Plate		Plates - Kick Plate
1	Plate		Wrap around

Non-Secure Side

Opening Remarks:
Issue Comments:

D9: Improper field modification or repair
 Comments:
 Corrective Action: Replace
 Issue Status: Non-Compliant



Building: SNF

Non-Compliant
Level: 418

Mark: 418-154

Secure Side

Description: 3' 8" x 6' 8" x 1 3/4" WD.F Wood HM.3F.M Hollow Metal FR-20

Issue Codes: D9

Hardware Set #: 55.95HL.69.5.KP.WP.MHO

Qty	Type	Description	Part Description
3	Hinge		Full Mortise - Standard - 5"x4-1/2" - Ball Bearing
1	Lockset		Cylindrical - Non-Electrified - Passage (F75) - Hospital Latch
1	Mag Hold Open		Surface - Medium Duty (Traffic) - Model
1	Closer		Surface - Push Side - Track
1	Plate		Plates - Kick Plate
1	Plate		Wrap around

Non-Secure Side

Opening Remarks:
Issue Comments:

D9: Improper field modification or repair
 Comments:
 Corrective Action: Replace
 Issue Status: Non-Compliant



Building: SNF

Non-Compliant
Level: 418

Mark: 418-155

Secure Side

Description: 3' 8" x 6' 8" x 1 3/4" WD.F Wood HM.3F.M Hollow Metal FR-20

Issue Codes: D9

Hardware Set #: 55.95HL.69.5.KP.WP.MHO

Qty	Type	Description	Part Description
3	Hinge		Full Mortise - Standard - 5"x4-1/2" - Ball Bearing
1	Lockset		Cylindrical - Non-Electrified - Passage (F75) - Hospital Latch
1	Mag Hold Open		Surface - Medium Duty (Traffic) - Model
1	Closer		Surface - Push Side - Track
1	Plate		Plates - Kick Plate
1	Plate		Wrap around

Non-Secure Side

Opening Remarks:
Issue Comments:

D9: Improper field modification or repair
 Comments:
 Corrective Action: Replace
 Issue Status: Non-Compliant

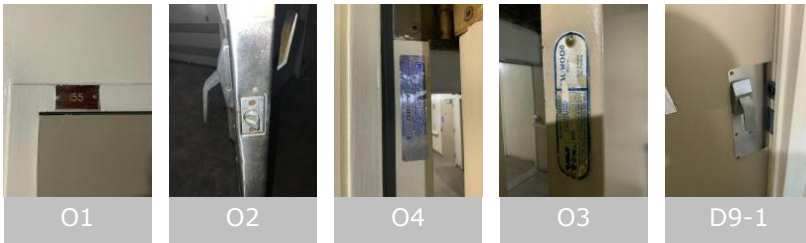

Building: SNF

Compliant

Level: 418

Mark: 418-156

Secure Side

Description: 3' 0" x 6' 8" x 1 3/4" WD.F Wood HM.3F.M Hollow Metal FR-20



Hardware Set #: 56.04M.69.7.KP

Qty	Type	Description	Part Description
3	Hinge		Full Mortise - Standard - 4-1/2"x4-1/2" - Ball Bearing
1	Lockset		Mortise - Non-Electrified - Store (F07) - Escutcheon - Knob
1	Closer		Surface - Push Side - Track
1	Plate		Plates - Kick Plate

Non-Secure Side



Opening Remarks:

Issue Comments:

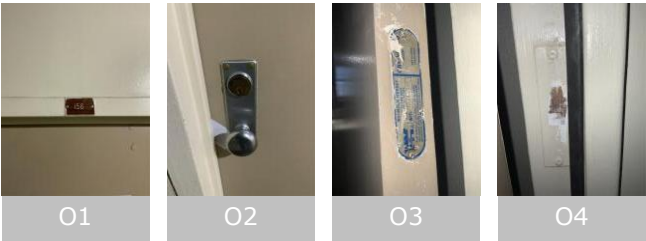

Building: SNF

Compliant

Level: 418

Mark: 418-157

Secure Side

Description: 3' 0" x 6' 8" x 1 3/4" WD.F Wood HM.3F.M Hollow Metal FR-20



Hardware Set #: 56.04M.69.7.KP

Qty Type Description

- 3 Hinge
- 1 Lockset
- 1 Closer
- 1 Plate

Part Description

- Full Mortise - Standard - 4-1/2"x4-1/2" - Ball Bearing
- Mortise - Non-Electrified - Store (F07) - Escutcheon - Knob
- Surface - Push Side - Track
- Plates - Kick Plate

Non-Secure Side



Opening Remarks:

Issue Comments:



Building: SNF

Non-Compliant

Level: 418

Mark: 418-162

Secure Side

Description: 3' 0" x 6' 8" x 1 3/4" WD.F Wood HM.3F.M Hollow Metal FR-20



Issue Codes: D2

Hardware Set #: 56.04M.69.7

Qty Type Description

- 3 Hinge
- 1 Lockset
- 1 Closer

Part Description

- Full Mortise - Standard - 4-1/2"x4-1/2" - Ball Bearing
- Mortise - Non-Electrified - Store (F07) - Escutcheon - Knob
- Surface - Push Side - Track

Non-Secure Side



Opening Remarks:

Issue Comments:

D2: Door damaged (bent, dented, delaminating)
 Comments:
 Corrective Action: Replace
 Issue Status: Non-Compliant

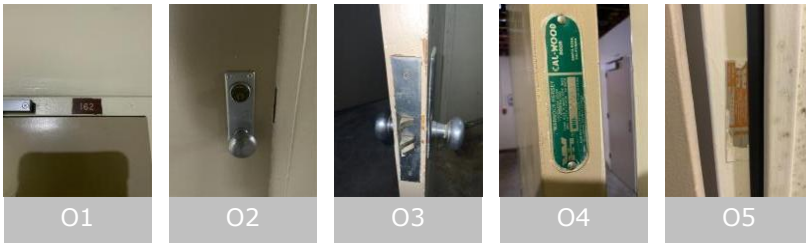

Building: SNF

Non-Compliant
Level: 418

Mark: 418-C100

Secure Side

Description: 6' 0" x 6' 8" x 1 3/4" WD.G Wood HM.3F.M Hollow Metal FR-20

Issue Codes: **D2**
Hardware Set #: 45.10.69.5.T.SV.KP.EG.MHO

Qty	Type	Description	Part Description
6	Hinge		Full Mortise - Standard - 5"x4-1/2" - Ball Bearing
2	Exit Device		Surface Vertical Rod - Exit Only
2	Mag Hold Open		Surface - Medium Duty (Traffic) - Model
2	Closer		Surface - Push Side - Track
2	Plate		Plates - Kick Plate
2	Plate		Guards - Edge Guards
1	Threshold		Saddle

Non-Secure Side

Opening Remarks:
Issue Comments:

D2: Door damaged (bent, dented, delaminating)
 Comments: Both doors split
 Corrective Action: Replace
 Issue Status: Non-Compliant



Building: SNF

Non-Compliant
Level: 419

Mark: 419-101A

Secure Side

Description: 3' 0" x 6' 8" x 1 3/4" WD.G Wood HM.3F.M Hollow Metal FR-20

Issue Codes: **D9**
Hardware Set #: 56.04M.69.7.KP.WP

Qty	Type	Description	Part Description
3	Hinge		Full Mortise - Standard - 4-1/2"x4-1/2" - Ball Bearing
1	Lockset		Mortise - Non-Electrified - Store (F07) - Escutcheon - Knob
1	Closer		Surface - Push Side - Track
1	Plate		Plates - Kick Plate
1	Plate		Wrap around

Non-Secure Side

Opening Remarks:
Issue Comments:

D9: Improper field modification or repair
 Comments:
 Corrective Action: Replace
 Issue Status: Non-Compliant

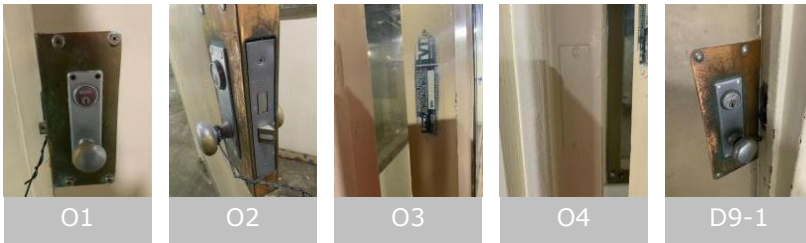

Building: SNF

Non-Compliant
Level: 419

Mark: 419-101B

Secure Side

Description: 3' 0" x 6' 8" x 1 3/4" WD.G Wood HM.3F.M Hollow Metal FR-20

Issue Codes: O1

Hardware Set #: 56.38M.69.7.KP.AP

Qty	Type	Description	Part Description
3	Hinge		Full Mortise - Standard - 4-1/2"x4-1/2" - Ball Bearing
1	Lockset		Mortise - Non-Electrified - CLASSROOM SECURITY
1	Closer		Surface - Push Side - Track
1	Plate		Plates - Kick Plate
1	Plate		Plates - Armor Plate

Non-Secure Side

Opening Remarks:
Issue Comments:

O1: Door does not swing freely
 Comments: Can't open door due to missing knob
 Issue Status: Non-Compliant

Building: SNF

Non-Compliant

Level: 419

Mark: 419-102

Secure Side

Description: 2' 6" x 6' 8" x 1 3/4" WD.F Wood HM.TR.M Hollow Metal FR-20



Issue Codes: D3, F4

Hardware Set #: 56.38M.50.4(4x4).

Qty	Type	Description	Part Description
3	Hinge		Full Mortise - Standard - 4"x4"
1	Lockset		Mortise - Non-Electrified - CLASSROOM SECURITY

Non-Secure Side



Opening Remarks:

Issue Comments:

D3: Missing/painted/illegible label
 Comments: Missing label
 Issue Status: Non-Compliant

F4: Missing/painted/illegible label
 Comments: Missing label
 Issue Status: Non-Compliant



O1



O2

Building: SNF

Non-Compliant
Level: 419

Mark: 419-104A

Secure Side

Description: 3' 0" x 6' 8" x 1 3/4" HM.G Hollow Metal HM.3F.M Hollow Metal FR-20

Issue Codes: **D3, F4, O5**
Hardware Set #: 56.38M.69.7.KP.

Qty	Type	Description	Part Description
3	Hinge		Full Mortise - Standard - 4-1/2"x4-1/2" - Ball Bearing
1	Lockset		Mortise - Non-Electrified - CLASSROOM SECURITY
1	Closer		Surface - Push Side - Track
1	Plate		Plates - Kick Plate

Non-Secure Side

Opening Remarks:
Issue Comments:

D3: Missing/painted/illegible label
 Comments: Painted
 Issue Status: Non-Compliant

F4: Missing/painted/illegible label
 Comments: Painted
 Issue Status: Non-Compliant

O5: Door drags on floor, rubs frame/rubs other door
 Comments: Rubs on frame
 Corrective Action: Adjust
 Issue Status: Non-Compliant

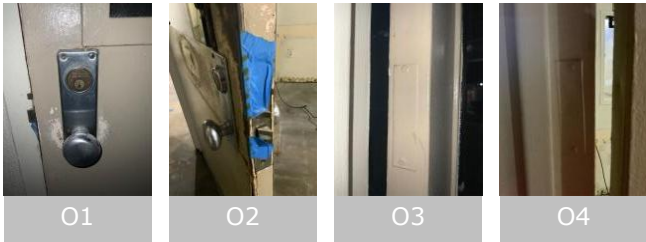

Building: SNF

Non-Compliant
Level: 419

Mark: 419-108

Secure Side

Description: 3' 0" x 6' 8" x 1 3/4" HM.F Hollow Metal HM.3F.M Hollow Metal FR-90

Issue Codes: **D2**
Hardware Set #: 26.04M.69.7.SW.

Qty	Type	Description	Part Description
3	Hinge		Full Mortise - Standard - 4-1/2"x4-1/2" - Ball Bearing
1	Lockset		Mortise - Non-Electrified - Store (F07) - Escutcheon - Knob
1	Closer		Surface - Push Side - Track
1	Sweep		Brush

Non-Secure Side

Opening Remarks:
Issue Comments:

D2: Door damaged (bent, dented, delaminating)
 Comments:
 Corrective Action: Replace
 Issue Status: Non-Compliant



Building: SNF

Non-Compliant
Level: 419

Mark: 419-109

Secure Side

Description: 4' 8" x 6' 8" x 1 3/4" WD.F Wood HM.3F.M Hollow Metal FR-20

Issue Codes: D2, F4

Hardware Set #: 56.04M.69.7.MF

Qty	Type	Description	Part Description
6	Hinge		Full Mortise - Standard - 4-1/2"x4-1/2" - Ball Bearing
1	Bolt		Concealed - Lever Extension
1	Lockset		Mortise - Non-Electrified - Store (F07) - Escutcheon - Knob
2	Closer		Surface - Push Side - Track

Non-Secure Side

Opening Remarks:
Issue Comments:

- D2: Door damaged (bent, dented, delaminating)
 Comments: Damage on inactive door. See photos.
 Corrective Action: Replace
 Issue Status: Non-Compliant
- F4: Missing/painted/illegible label
 Comments: Label is painted over
 Corrective Action: Contact ASSA ABLOY for field labeling
 Issue Status: Non-Compliant

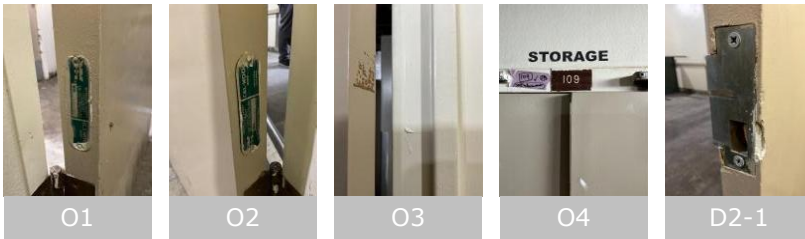

Building: SNF

Non-Compliant

Level: 419

Mark: 419-110

Secure Side

Description: 2' 6" x 6' 8" x 1 3/4" WD.F Wood HM.3F.M Hollow Metal FR-20



Issue Codes: D2

Hardware Set #: 56.04M.69.7

Qty Type Description

- 3 Hinge
- 1 Lockset
- 1 Closer

Part Description

- Full Mortise - Standard - 4-1/2"x4-1/2"
- Ball Bearing
- Mortise - Non-Electrified - Store (F07) -
Escutcheon - Knob
- Surface - Push Side - Track

Non-Secure Side



Opening Remarks:

Issue Comments:

D2: Door damaged (bent, dented, delaminating)
 Comments:
 Corrective Action: Replace
 Issue Status: Non-Compliant



Building: SNF

Non-Compliant
Level: 419

Mark: 419-111

Secure Side

Description: 3' 0" x 6' 8" x 1 3/4" WD.F Wood HM.TR.M Hollow Metal FR-20

Issue Codes: D2

Hardware Set #: 56.04M.69.5.KP.WP

Qty	Type	Description	Part Description
3	Hinge		Full Mortise - Standard - 5"x4-1/2" - Ball Bearing
1	Lockset		Mortise - Non-Electrified - Store (F07) - Escutcheon - Knob
1	Closer		Surface - Push Side - Track
1	Plate		Plates - Kick Plate
1	Plate		Wrap around

Non-Secure Side

Opening Remarks:
Issue Comments:

D2: Door damaged (bent, dented, delaminating)
 Comments:
 Corrective Action: Replace
 Issue Status: Non-Compliant

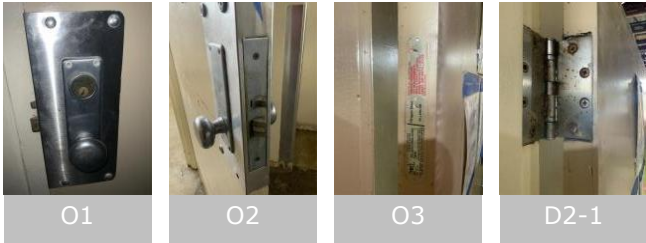

Building: SNF

Non-Compliant
Level: 419

Mark: 419-113

Secure Side

Description: 3' 0" x 6' 8" x 1 3/4" WD.F Wood HM.3F.M Hollow Metal FR-20

Issue Codes: **D9**
Hardware Set #: 55.95HL.69.5.T.WP

Qty	Type	Description	Part Description
3	Hinge		Full Mortise - Standard - 5"x4-1/2" - Ball Bearing
1	Lockset		Cylindrical - Non-Electrified - Passage (F75) - Hospital Latch
1	Closer		Surface - Push Side - Track
1	Plate		Wrap around
1	Threshold		Saddle

Non-Secure Side

Opening Remarks:
Issue Comments:

D9: Improper field modification or repair
 Comments:
 Corrective Action: Replace
 Issue Status: Non-Compliant



Building: SNF

Non-Compliant
Level: 419

Mark: 419-115

Secure Side

Description: 3' 8" x 6' 8" x 1 3/4" WD.F Wood HM.3F.M Hollow Metal FR-20

Issue Codes: D9

Hardware Set #: 55.95HL.69.5.KP.WP

Qty	Type	Description	Part Description
3	Hinge		Full Mortise - Standard - 5"x4-1/2" - Ball Bearing
1	Lockset		Cylindrical - Non-Electrified - Passage (F75) - Hospital Latch
2	Closer		Surface - Push Side - Track
1	Plate		Plates - Kick Plate
1	Plate		Wrap around

Non-Secure Side

Opening Remarks:
Issue Comments:

D9: Improper field modification or repair
 Comments:
 Corrective Action: Replace
 Issue Status: Non-Compliant



Building: SNF

Non-Compliant
Level: 419

Mark: 419-116

Secure Side

Description: 3' 8" x 6' 8" x 1 3/4" WD.F Wood HM.3F.M Hollow Metal FR-20

Issue Codes: D9

Hardware Set #: 55.95HL.69.5.KP.WP.MHO

Qty	Type	Description	Part Description
3	Hinge		Full Mortise - Standard - 5"x4-1/2" - Ball Bearing
1	Lockset		Cylindrical - Non-Electrified - Passage (F75) - Hospital Latch
1	Mag Hold Open		Surface - Medium Duty (Traffic) - Model
1	Closer		Surface - Push Side - Track
1	Plate		Plates - Kick Plate
1	Plate		Wrap around

Non-Secure Side

Opening Remarks:
Issue Comments:

D9: Improper field modification or repair
 Comments:
 Corrective Action: Replace
 Issue Status: Non-Compliant



Building: SNF

Non-Compliant
Level: 419

Mark: 419-117

Secure Side

Description: 3' 8" x 6' 8" x 1 3/4" WD.F Wood HM.3F.M Hollow Metal FR-20

Issue Codes: D9, F4

Hardware Set #: 55.95HL.69.5.WP.MHO

Qty	Type	Description	Part Description
3	Hinge		Full Mortise - Standard - 5"x4-1/2" - Ball Bearing
1	Lockset		Cylindrical - Non-Electrified - Passage (F75) - Hospital Latch
1	Mag Hold Open		Surface - Medium Duty (Traffic) - Model
1	Closer		Surface - Push Side - Track
1	Plate		Wrap around

Non-Secure Side

Opening Remarks:
Issue Comments:

D9: Improper field modification or repair
 Comments:
 Corrective Action: Replace
 Issue Status: Non-Compliant

F4: Missing/painted/illegible label
 Comments: Painted Label
 Issue Status: Non-Compliant

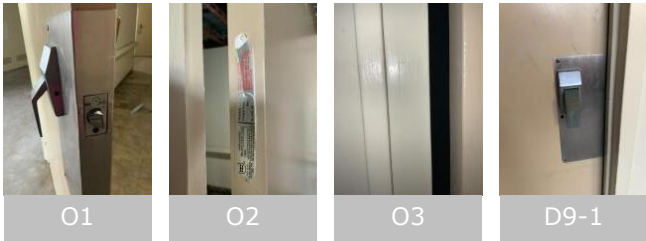

Building: SNF

Non-Compliant
Level: 419

Mark: 419-118

Secure Side

Description: 3' 8" x 6' 8" x 1 3/4" WD.F Wood HM.3F.M Hollow Metal FR-20

Issue Codes: **D9**
Hardware Set #: 55.95HL.69.5.KP.WP.MHO

Qty	Type	Description	Part Description
3	Hinge		Full Mortise - Standard - 5"x4-1/2" - Ball Bearing
1	Lockset		Cylindrical - Non-Electrified - Passage (F75) - Hospital Latch
1	Mag Hold Open		Surface - Medium Duty (Traffic) - Model
1	Closer		Surface - Push Side - Track
1	Plate		Plates - Kick Plate
1	Plate		Wrap around

Non-Secure Side

Opening Remarks:
Issue Comments:

D9: Improper field modification or repair
 Comments:
 Corrective Action: Replace
 Issue Status: Non-Compliant



Building: SNF

Compliant

Level: 419

Mark: 419-122

Secure Side

Description: 2' 6" x 6' 8" x 1 3/4" WD.F Wood HM.3F.M Hollow Metal FR-20



Hardware Set #: 56.04M.69.7

Qty Type Description

- 3 Hinge
- 1 Lockset
- 1 Closer

Part Description

- Full Mortise - Standard - 4-1/2"x4-1/2" - Ball Bearing
- Mortise - Non-Electrified - Store (F07) - Escutcheon - Knob
- Surface - Push Side - Track

Non-Secure Side



Opening Remarks:

Issue Comments:



O2



O1



O3



O4

Building: SNF

Non-Compliant
Level: 419

Mark: 419-123

Secure Side

Description: 3' 0" x 6' 8" x 1 3/4" HM.F Hollow Metal HM.3F.M Hollow Metal FR-90

Issue Codes: D2

Hardware Set #: 26.38M.69.7.SW.

Qty	Type	Description	Part Description
3	Hinge		Full Mortise - Standard - 4-1/2"x4-1/2" - Ball Bearing
1	Lockset		Mortise - Non-Electrified - CLASSROOM SECURITY
1	Closer		Surface - Push Side - Track
1	Sweep		Brush

Non-Secure Side

Opening Remarks:
Issue Comments:

D2: Door damaged (bent, dented, delaminating)

Comments:

Corrective Action: Replace

Issue Status: Non-Compliant



O1



O2



O3



D2-1

Building: SNF

Non-Compliant
Level: 419

Mark: 419-125

Secure Side

Description: 3' 0" x 6' 8" x 1 3/4" WD.F Wood HM.3F.M Hollow Metal FR-20

Issue Codes: D9

Hardware Set #: 55.95HL.69.5.KP.WP

Qty	Type	Description	Part Description
3	Hinge		Full Mortise - Standard - 5"x4-1/2" - Ball Bearing
1	Lockset		Cylindrical - Non-Electrified - Passage (F75) - Hospital Latch
2	Closer		Surface - Push Side - Track
1	Plate		Plates - Kick Plate
1	Plate		Wrap around

Non-Secure Side

Opening Remarks:
Issue Comments:

D9: Improper field modification or repair
 Comments:
 Corrective Action: Replace
 Issue Status: Non-Compliant



Building: SNF

Compliant

Level: 419

Mark: 419-126

Secure Side

Description: 3' 0" x 6' 8" x 1 3/4" WD.F Wood HM.3F.M Hollow Metal FR-20



Hardware Set #: 56.04M.69.5.

Qty Type Description

- 3 Hinge
- 1 Lockset
- 1 Closer

Part Description

- Full Mortise - Standard - 5"x4-1/2" - Ball Bearing
- Mortise - Non-Electrified - Store (F07) - Escutcheon - Knob
- Surface - Push Side - Track

Non-Secure Side



Opening Remarks:

Issue Comments:



O1



O2



O3

Building: SNF

Non-Compliant
Level: 419

Mark: 419-127

Secure Side

Description: 3' 8" x 6' 8" x 1 3/4" WD.F Wood HM.3F.M Hollow Metal FR-20

Issue Codes: **D2, D9, F4**
Hardware Set #: 55.95HL.69.5.KP.WP

Qty	Type	Description	Part Description
3	Hinge		Full Mortise - Standard - 5"x4-1/2" - Ball Bearing
1	Lockset		Cylindrical - Non-Electrified - Passage (F75) - Hospital Latch
2	Closer		Surface - Push Side - Track
1	Plate		Plates - Kick Plate
1	Plate		Wrap around

Non-Secure Side

Opening Remarks:
Issue Comments:

D2: Door damaged (bent, dented, delaminating)

Comments:

Issue Status: Non-Compliant

D9: Improper field modification or repair

Comments:

Corrective Action: Replace

Issue Status: Non-Compliant

F4: Missing/painted/illegible label

Comments: Missing

Issue Status: Non-Compliant

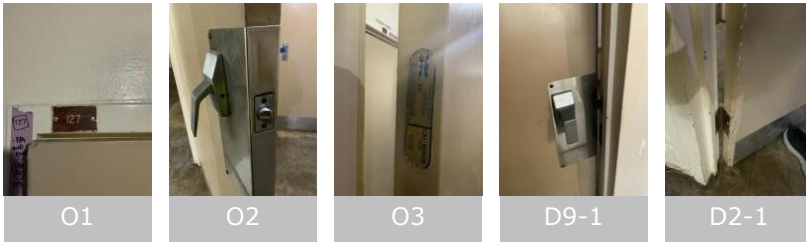

Building: SNF

Non-Compliant
Level: 417

Mark: 417-128

Secure Side

Description: 3' 8" x 6' 8" x 1 3/4" WD.F Wood HM.3F.M Hollow Metal FR-20

Issue Codes: **D9, F4**
Hardware Set #: 55.95HL/03.69.5.KP.WP

Qty	Type	Description	Part Description
3	Hinge		Full Mortise - Standard - 5"x4-1/2" - Ball Bearing
1	Lockset		Cylindrical - Non-Electrified - Passage (F75) - Hospital Latch
1	Lockset		Deadbolt - Mortise - Small Body Deadbolt - Double Cylinder
1	Closer		Surface - Push Side - Track
1	Plate		Plates - Kick Plate
1	Plate		Wrap around

Non-Secure Side

Opening Remarks:
Issue Comments:

- D9: Improper field modification or repair
 Comments:
 Corrective Action: Replace
 Issue Status: Non-Compliant
- F4: Missing/painted/illegible label
 Comments: Missing
 Issue Status: Non-Compliant

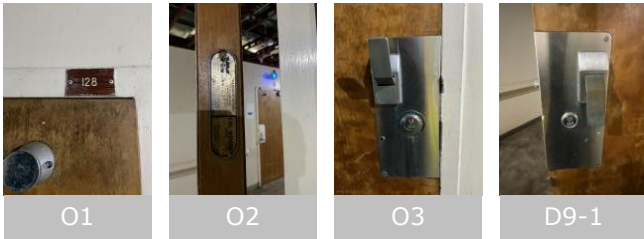

Building: SNF

Non-Compliant
Level: 417

Mark: 417-129

Secure Side

Description: 3' 8" x 6' 8" x 1 3/4" WD.F Wood HM.3F.M Hollow Metal FR-20

Issue Codes: D2, D9, F4

Hardware Set #: 56.05M.69.5.KP.WP

Qty	Type	Description	Part Description
3	Hinge		Full Mortise - Standard - 5"x4-1/2" - Ball Bearing
1	Lockset		Mortise - Non-Electrified - Ent/Off (F04) - Escutcheon - Knob
1	Closer		Surface - Push Side - Track
1	Plate		Plates - Kick Plate
1	Plate		Wrap around

Non-Secure Side

Opening Remarks:
Issue Comments:

D2: Door damaged (bent, dented, delaminating)

Comments:

Corrective Action: Replace

Issue Status: Non-Compliant

D9: Improper field modification or repair

Comments:

Corrective Action: Replace

Issue Status: Non-Compliant

F4: Missing/painted/illegible label

Comments: Missing

Issue Status: Non-Compliant



O2



O1



O4



O3



D2-1



D2-2



D9-1

Building: SNF

Non-Compliant
Level: 417

Mark: 417-130

Secure Side

Description: 3' 8" x 6' 8" x 1 3/4" WD.F Wood HM.3F.M Hollow Metal FR-20

Issue Codes: **D2, D9, F4**
Hardware Set #: 55.95HL/03.69.5.KP.WP

Qty	Type	Description	Part Description
3	Hinge		Full Mortise - Standard - 5"x4-1/2" - Ball Bearing
1	Lockset		Cylindrical - Non-Electrified - Passage (F75) - Hospital Latch
1	Lockset		Deadbolt - Mortise - Small Body Deadbolt - Double Cylinder
1	Closer		Surface - Push Side - Track
1	Plate		Plates - Kick Plate
1	Plate		Wrap around

Non-Secure Side

Opening Remarks:
Issue Comments:

D2: Door damaged (bent, dented, delaminating)

Comments:

Corrective Action: Replace

Issue Status: Non-Compliant

D9: Improper field modification or repair

Comments:

Issue Status: Non-Compliant

F4: Missing/painted/illegible label

Comments: Missing

Issue Status: Non-Compliant



O1



O2



O3



O4



D2-1



D9-1

Building: SNF

Non-Compliant
Level: 419

Mark: 419-132

Secure Side

Description: 2' 6" x 6' 8" x 1 3/4" HM.F Hollow Metal HM.3F.M Hollow Metal FR-20

Issue Codes: **D2, D3, F2, F4, O5**
Hardware Set #: 56.04M.69.7

Qty	Type	Description	Part Description
3	Hinge		Full Mortise - Standard - 4-1/2"x4-1/2" - Ball Bearing
1	Lockset		Mortise - Non-Electrified - Store (F07) - Escutcheon - Knob
1	Closer		Surface - Push Side - Track

Non-Secure Side

Opening Remarks:
Issue Comments:

- D2: Door damaged (bent, dented, delaminating)
Comments: Split at hinges
Corrective Action: Replace
Issue Status: Non-Compliant
- D3: Missing/painted/illegible label
Comments: Label missing
Corrective Action: Contact ASSA Abloy for field labeling
Issue Status: Non-Compliant
- F2: Damaged/rust through on frame
Comments: Rust through at bottom of brain
Corrective Action: Replace
Issue Status: Non-Compliant
- F4: Missing/painted/illegible label
Comments: Painted
Corrective Action: Contact ASSA Abloy for field labeling
Issue Status: Non-Compliant
- O5: Door drags on floor, rubs frame/rubs other door
Comments: Rubs on strike side
Corrective Action: Adjust to function New or Replace
Issue Status: Non-Compliant



O1



O2



O3



O4



F2-1



F2-2



D2-1



D2-2



F4-1

Building: SNF

Non-Compliant
Level: 419

Mark: 419-133

Secure Side

Description: 3' 8" x 6' 8" x 1 3/4" WD.F Wood HM.3F.M Hollow Metal FR-20

Issue Codes: **D2, D9**
Hardware Set #: 55.95HL/03.69.5.KP.WP

Qty	Type	Description	Part Description
3	Hinge		Full Mortise - Standard - 5"x4-1/2" - Ball Bearing
1	Lockset		Cylindrical - Non-Electrified - Passage (F75) - Hospital Latch
1	Lockset		Deadbolt - Mortise - Small Body Deadbolt - Double Cylinder
1	Closer		Surface - Push Side - Track
1	Plate		Plates - Kick Plate
1	Plate		Wrap around

Non-Secure Side

Opening Remarks:
Issue Comments:

D2: Door damaged (bent, dented, delaminating)
 Comments: Damages , non water related
 Corrective Action: Replace
 Issue Status: Non-Compliant

D9: Improper field modification or repair
 Comments:
 Issue Status: Non-Compliant



Building: SNF

Non-Compliant
Level: 419

Mark: 419-134

Secure Side

Description: 3' 0" x 6' 8" x 1 3/4" WD.F Wood HM.3F.M Hollow Metal FR-20

Issue Codes: D2

Hardware Set #: 56.38M/03C.69.7

Qty	Type	Description	Part Description
3	Hinge		Full Mortise - Standard - 4-1/2"x4-1/2" - Ball Bearing
1	Lockset		Mortise - Non-Electrified - CLASSROOM SECURITY
1	Lockset		Deadbolt - Cylindrical - Cylinder x thumbturn
1	Closer		Surface - Push Side - Track
1	Plate		Plates - Kick Plate

Non-Secure Side

Opening Remarks:
Issue Comments:

D2: Door damaged (bent, dented, delaminating)
 Comments: Water damage
 Corrective Action: Replace
 Issue Status: Non-Compliant

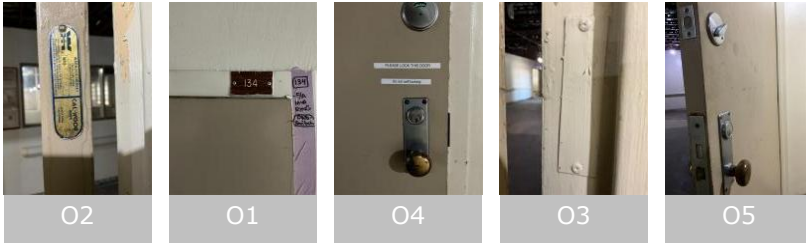

Building: SNF

Non-Compliant
Level: 419

Mark: 419-135

Secure Side

Description: 3' 8" x 6' 8" x 1 3/4" WD.F Wood HM.3F.M Hollow Metal FR-20

Issue Codes: **D9, F4**
Hardware Set #: 55.95HL/03.69.5.KP.WP

Qty	Type	Description	Part Description
3	Hinge		Full Mortise - Standard - 5"x4-1/2" - Ball Bearing
1	Lockset		Cylindrical - Non-Electrified - Passage (F75) - Hospital Latch
1	Lockset		Deadbolt - Mortise - Small Body Deadbolt - Double Cylinder
1	Closer		Surface - Push Side - Track
1	Plate		Plates - Kick Plate
1	Plate		Wrap around

Non-Secure Side

Opening Remarks:
Issue Comments:

D9: Improper field modification or repair

Comments:

Corrective Action: Replace

Issue Status: Non-Compliant

F4: Missing/painted/illegible label

Comments: Label missing.

Corrective Action: Contact ASSA Abloy field labeling

Issue Status: Non-Compliant



O1



O2



O3



O4



O5



F4-1



D9-1

Building: SNF

Non-Compliant
Level: 419

Mark: 419-136

Secure Side

Description: 3' 8" x 6' 8" x 1 3/4" WD.F Wood HM.3F.M Hollow Metal FR-20

Issue Codes: **D2, D8, F4**
Hardware Set #: 55.95HL.69.5.KP.WP

Qty	Type	Description	Part Description
3	Hinge		Full Mortise - Standard - 5"x4-1/2" - Ball Bearing
1	Lockset		Cylindrical - Non-Electrified - Passage (F75) - Hospital Latch
2	Closer		Surface - Push Side - Track
1	Plate		Plates - Kick Plate
1	Plate		Wrap around

Non-Secure Side

Opening Remarks:
Issue Comments:

- D2: Door damaged (bent, dented, delaminating)
 Comments:
 Corrective Action: Replace
 Issue Status: Non-Compliant
- D8: Unused fastener holes/wrong door prep
 Comments:
 Corrective Action: Replace
 Issue Status: Non-Compliant
- F4: Missing/painted/illegible label
 Comments: Missing label
 Corrective Action: Contact ASSA Abloy for field labeling
 Issue Status: Non-Compliant



O1



O2



O3



O4



D2-1



D2-2



D8-1



F4-1

Building: SNF

Compliant

Level: 419

Mark: 419-137

Secure Side

Description: 3' 0" x 6' 8" x 1 3/4" WD.F Wood HM.3F.M Hollow Metal FR-20



Hardware Set #: 56.04M.69.7

Qty Type Description

- 3 Hinge
- 1 Lockset
- 1 Closer

Part Description

- Full Mortise - Standard - 4-1/2"x4-1/2" - Ball Bearing
- Mortise - Non-Electrified - Store (F07) - Escutcheon - Knob
- Surface - Push Side - Track

Non-Secure Side



Opening Remarks:

Issue Comments:



O1



O2



O3

Building: SNF

Non-Compliant
Level: 419

Mark: 419-139

Secure Side

Description: 3' 8" x 6' 8" x 1 3/4" WD.F Wood HM.3F.M Hollow Metal FR-20

Issue Codes: D9, O5

Hardware Set #: 55.95HL.69.5.KP.WP

Qty	Type	Description	Part Description
3	Hinge		Full Mortise - Standard - 5"x4-1/2" - Ball Bearing
1	Lockset		Cylindrical - Non-Electrified - Passage (F75) - Hospital Latch
2	Closer		Surface - Push Side - Track
1	Plate		Plates - Kick Plate
1	Plate		Wrap around

Non-Secure Side

Opening Remarks:
Issue Comments:

D9: Improper field modification or repair
 Comments:
 Corrective Action: Replace
 Issue Status: Non-Compliant

O5: Door drags on floor, rubs frame/rubs other door
 Comments: Rubs at top strike corner
 Issue Status: Non-Compliant



Building: SNF

Non-Compliant
Level: 419

Mark: 419-140

Secure Side

Description: 3' 0" x 7' 0" x 1 3/4" WD.F Wood HM.3F.M Hollow Metal FR-20

Issue Codes: D2

Hardware Set #: 56.04M.69.7.KP

Qty	Type	Description	Part Description
3	Hinge		Full Mortise - Standard - 4-1/2"x4-1/2" - Ball Bearing
1	Lockset		Mortise - Non-Electrified - Store (F07) - Escutcheon - Knob
1	Closer		Surface - Push Side - Track
1	Plate		Plates - Kick Plate

Non-Secure Side

Opening Remarks:
Issue Comments:

D2: Door damaged (bent, dented, delaminating)
 Comments:
 Corrective Action: Replace
 Issue Status: Non-Compliant

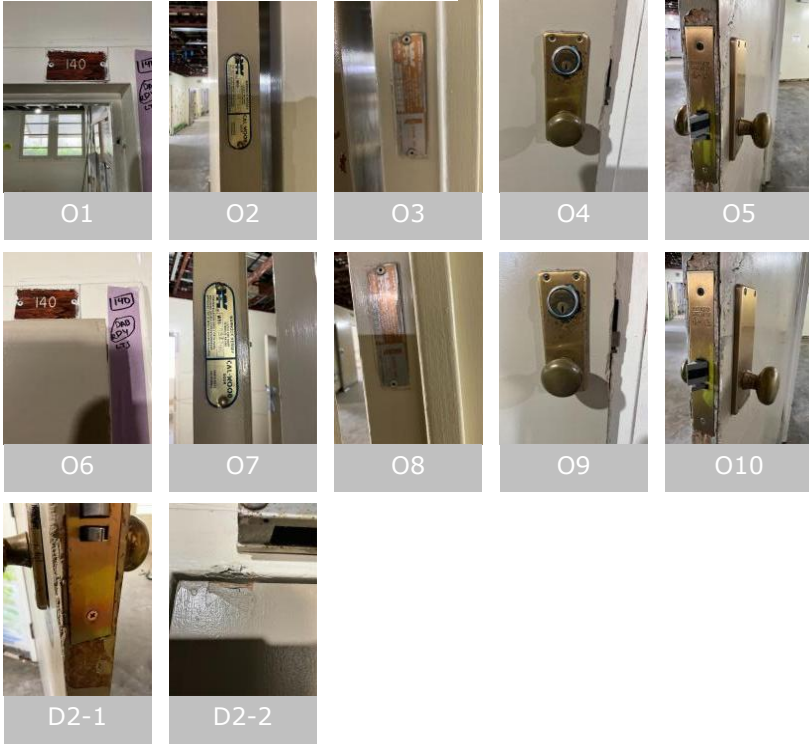

Building: SNF

Non-Compliant
Level: 419

Mark: 419-141

Secure Side

Description: 3' 0" x 6' 8" x 1 3/4" WD.F Wood HM.3F.M Hollow Metal FR-20

Issue Codes: **D2, D9, F4**
Hardware Set #: 56.04M.69.7.KP.WP

Qty	Type	Description	Part Description
3	Hinge		Full Mortise - Standard - 4-1/2"x4-1/2" - Ball Bearing
1	Lockset		Mortise - Non-Electrified - Store (F07) - Escutcheon - Knob
1	Closer		Surface - Push Side - Track
1	Plate		Plates - Kick Plate
1	Plate		Wrap around

Non-Secure Side

Opening Remarks:
Issue Comments:

D2: Door damaged (bent, dented, delaminating)

Comments:

Corrective Action: Replace

Issue Status: Non-Compliant

D9: Improper field modification or repair

Comments:

Corrective Action: Replace

Issue Status: Non-Compliant

F4: Missing/painted/illegible label

Comments: Timestamp is painted over

Issue Status: Non-Compliant



O1



O2



O3



O4



O5



F4-1



D9-1



D2-1



D2-2

Building: SNF

Non-Compliant
Level: 419

Mark: 419-142

Secure Side

Description: 3' 0" x 6' 8" x 1 3/4" HM.DD Hollow Metal HM.3F.M Hollow Metal FR-20

Issue Codes: **D3, D9**
Hardware Set #: 56.04M/04C.69.7

Qty	Type	Description	Part Description
4	Hinge		Full Mortise - Standard - 4-1/2"x4-1/2" - Ball Bearing
1	Lockset		Mortise - Non-Electrified - Store (F07) - Escutcheon - Knob
1	Lockset		Cylindrical - Non-Electrified - Store (F86) - Knob
1	Closer		Surface - Push Side - Track

Non-Secure Side

Opening Remarks:
Issue Comments:
D3: Missing/painted/illegible label

Comments: Label on top door is painted over. There is no label on the bottom of the door.

Corrective Action: Contact ASSA ABLOY for field labeling

Issue Status: Non-Compliant

D9: Improper field modification or repair

Comments: Appears to have been modified in the field. Appears door was cut in field two separate top from bottom.

Issue Status: Non-Compliant



01



02



03



04



05



D9-1



D9-2

Building: SNF

Non-Compliant
Level: 419

Mark: 419-143

Secure Side

Description: 3' 0" x 6' 8" x 1 3/4" WD.F Wood HM.3F.M Hollow Metal FR-20

Issue Codes: **D2**
Hardware Set #: 56.38M/03C.69.7.KP

Qty	Type	Description	Part Description
3	Hinge		Full Mortise - Standard - 4-1/2"x4-1/2" - Ball Bearing
1	Lockset		Mortise - Non-Electrified - CLASSROOM SECURITY
1	Lockset		Deadbolt - Cylindrical - Cylinder x thumbturn
1	Closer		Surface - Push Side - Track
1	Plate		Plates - Kick Plate

Non-Secure Side

Opening Remarks:
Issue Comments:

D2: Door damaged (bent, dented, delaminating)
 Comments: Rounding at top hinge side
 Corrective Action: Replace
 Issue Status: Non-Compliant

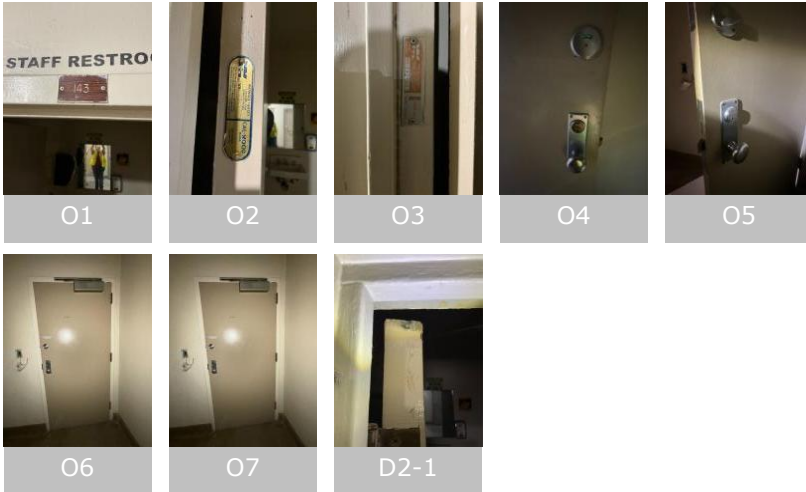

Building: SNF

Non-Compliant
Level: 419

Mark: 419-145

Secure Side

Description: 3' 0" x 6' 8" x 1 3/4" WD.F Wood HM.3F.M Hollow Metal FR-20

Issue Codes: **D2**
Hardware Set #: 56.04M.69.7.KP

Qty	Type	Description	Part Description
3	Hinge		Full Mortise - Standard - 4-1/2"x4-1/2" - Ball Bearing
1	Lockset		Mortise - Non-Electrified - Store (F07) - Escutcheon - Knob
1	Closer		Surface - Push Side - Track
1	Plate		Plates - Kick Plate

Non-Secure Side

Opening Remarks:
Issue Comments:

D2: Door damaged (bent, dented, delaminating)
 Comments: Multiple areas of damage
 Issue Status: Non-Compliant

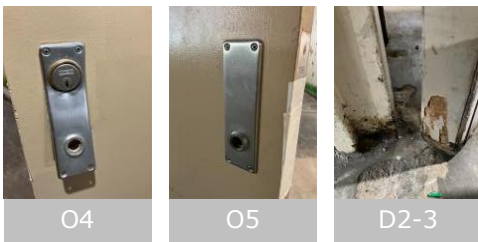
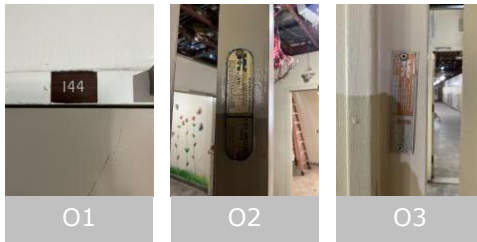

Building: SNF

Non-Compliant
Level: 419

Mark: 419-146

Secure Side

Description: 3' 0" x 7' 0" x 1 3/4" WD.F Wood HM.TR.M Hollow Metal FR-20

Issue Codes: **D3, F4**
Hardware Set #: 56.04M.69.7

Qty Type Description

- 3 Hinge
- 1 Lockset
- 1 Closer

Part Description

- Full Mortise - Standard - 4-1/2"x4-1/2"
- Ball Bearing
- Mortise - Non-Electrified - Store (F07) -
Escutcheon - Knob
- Surface - Push Side - Track

Non-Secure Side

Opening Remarks:
Issue Comments:

- D3: Missing/painted/illegible label
Comments: Missing
Issue Status: Non-Compliant
- F4: Missing/painted/illegible label
Comments: Missing
Issue Status: Non-Compliant

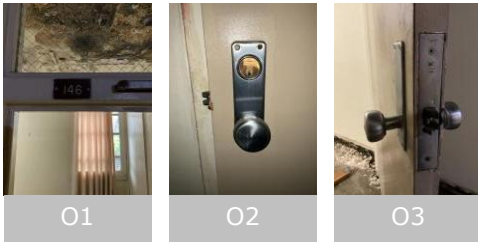

Building: SNF

Non-Compliant
Level: 419

Mark: 419-147

Secure Side

Description: 2' 6" x 6' 8" x 1 3/4" WD.F Wood HM.TR.M Hollow Metal FR-20

Issue Codes: D2, F4

Hardware Set #: 56.04M.69.4(4")

Qty	Type	Description	Part Description
3	Hinge		Full Mortise - Standard - 4"x4"
1	Lockset		Mortise - Non-Electrified - Store (F07) - Escutcheon - Knob
1	Closer		Surface - Push Side - Track

Non-Secure Side

Opening Remarks:
Issue Comments:

D2: Door damaged (bent, dented, delaminating)

Comments:

Corrective Action: Replace

Issue Status: Non-Compliant

F4: Missing/painted/illegible label

Comments: Label missing.

Corrective Action: See Remarks

Issue Status: Non-Compliant



D2-2



D2-3



D2-1

Building: SNF

Non-Compliant
Level: 419

Mark: 419-150

Secure Side

Description: 3' 8" x 6' 8" x 1 3/4" WD.G Wood HM.3F.M Hollow Metal FR-20

Issue Codes: **D2, F4**
Hardware Set #: 55.37M.69.5.MHO

Qty	Type	Description	Part Description
3	Hinge		Full Mortise - Standard - 5"x4-1/2" - Ball Bearing
1	Lockset		Mortise - Non-Electrified - Class (F05) - Escutcheon - Knob - Thumbturn
1	Mag Hold Open		Surface - Medium Duty (Traffic) - Model
1	Closer		Surface - Push Side - Track

Non-Secure Side

Opening Remarks:
Issue Comments:

D2: Door damaged (bent, dented, delaminating)

Comments:

Corrective Action: Replace

Issue Status: Non-Compliant

F4: Missing/painted/illegible label

Comments: Painted

Issue Status: Non-Compliant

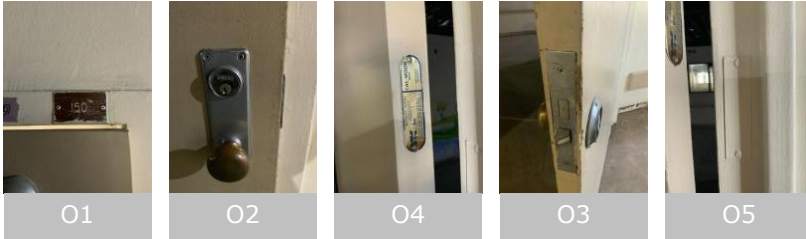

Building: SNF

Non-Compliant
Level: 419

Mark: 419-152

Secure Side

Description: 3' 8" x 6' 8" x 1 3/4" WD.G Wood HM.3F.M Hollow Metal FR-20

Issue Codes: **D9, F4**
Hardware Set #: 55.95HL.69.5.WP.MHO

Qty	Type	Description	Part Description
3	Hinge		Full Mortise - Standard - 5"x4-1/2" - Ball Bearing
1	Lockset		Cylindrical - Non-Electrified - Passage (F75) - Hospital Latch
1	Mag Hold Open		Surface - Medium Duty (Traffic) - Model
1	Closer		Surface - Push Side - Track
1	Plate		Wrap around

Non-Secure Side

Opening Remarks:
Issue Comments:

D9: Improper field modification or repair

Comments:

Corrective Action: Replace

Issue Status: Non-Compliant

F4: Missing/painted/illegible label

Comments: Missing

Issue Status: Non-Compliant

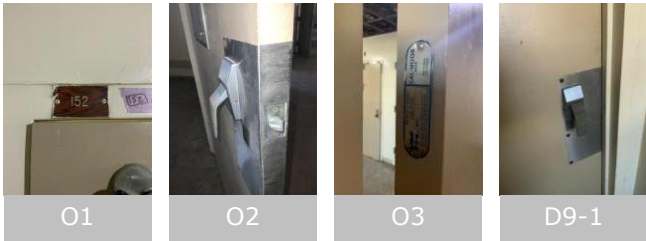

Building: SNF

Non-Compliant
Level: 419

Mark: 419-153

Secure Side

Description: 3' 8" x 6' 8" x 1 3/4" WD.F Wood HM.3F.M Hollow Metal FR-20

Issue Codes: **D9**
Hardware Set #: 55.95HL.69.5.KP.WP.MHO

Qty	Type	Description	Part Description
3	Hinge		Full Mortise - Standard - 5"x4-1/2" - Ball Bearing
1	Lockset		Cylindrical - Non-Electrified - Passage (F75) - Hospital Latch
1	Mag Hold Open		Surface - Medium Duty (Traffic) - Model
1	Closer		Surface - Push Side - Track
1	Plate		Plates - Kick Plate
1	Plate		Wrap around

Non-Secure Side

Opening Remarks:
Issue Comments:

D9: Improper field modification or repair
 Comments:
 Corrective Action: Replace
 Issue Status: Non-Compliant



Building: SNF

Non-Compliant
Level: 419

Mark: 419-155

Secure Side

Description: 3' 8" x 6' 8" x 1 3/4" WD.F Wood HM.3F.M Hollow Metal FR-20

Issue Codes: D2, D9, F4

Hardware Set #: 55.95HL.69.5.KP.WP.MHO

Qty	Type	Description	Part Description
3	Hinge		Full Mortise - Standard - 5"x4-1/2" - Ball Bearing
1	Lockset		Cylindrical - Non-Electrified - Passage (F75) - Hospital Latch
1	Mag Hold Open		Surface - Medium Duty (Traffic) - Model
1	Closer		Surface - Push Side - Track
1	Plate		Plates - Kick Plate
1	Plate		Wrap around

Non-Secure Side

Opening Remarks:
Issue Comments:

D2: Door damaged (bent, dented, delaminating)

Comments:

Corrective Action: Replace

Issue Status: Non-Compliant

D9: Improper field modification or repair

Comments:

Corrective Action: Replace

Issue Status: Non-Compliant

F4: Missing/painted/illegible label

Comments: Missing

Issue Status: Non-Compliant



O2



O1



O3



D9-1



D2-1

Building: SNF

Non-Compliant
Level: 419

Mark: 419-156

Secure Side

Description: 3' 0" x 6' 8" x 1 3/4" WD.F Wood HM.3F.M Hollow Metal FR-20

Issue Codes: **D2**
Hardware Set #: 56.04M.69.7.KP

Qty Type Description

- 3 Hinge
- 1 Lockset
- 1 Closer
- 1 Plate

Part Description

- Full Mortise - Standard - 4-1/2"x4-1/2" - Ball Bearing
- Mortise - Non-Electrified - Store (F07) - Escutcheon - Knob
- Surface - Push Side - Track
- Plates - Kick Plate

Non-Secure Side

Opening Remarks:
Issue Comments:

D2: Door damaged (bent, dented, delaminating)

Comments:

Corrective Action: Replace

Issue Status: Non-Compliant



O1



O3



O2



O4



O5



D2-1

Building: SNF

Non-Compliant
Level: 419

Mark: 419-157

Secure Side

Description: 3' 0" x 6' 8" x 1 3/4" WD.F Wood HM.3F.M Hollow Metal FR-20

Issue Codes: **D2**
Hardware Set #: 56.04M.69.7.KP

Qty	Type	Description	Part Description
3	Hinge		Full Mortise - Standard - 4-1/2"x4-1/2" - Ball Bearing
1	Lockset		Mortise - Non-Electrified - Store (F07) - Escutcheon - Knob
1	Closer		Surface - Push Side - Track
1	Plate		Plates - Kick Plate

Non-Secure Side

Opening Remarks:
Issue Comments:

D2: Door damaged (bent, dented, delaminating)

Comments:

Issue Status: Non-Compliant

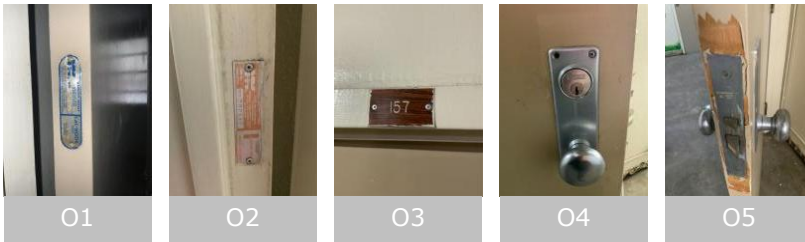

Building: SNF

Non-Compliant

Level: 419

Mark: 419-158

Secure Side

Description: 3' 0" x 6' 8" x 1 3/4" WD.F Wood HM.3F.M Hollow Metal FR-20



Issue Codes: **LO1**

Hardware Set #: 56.04M.69.7

Qty Type Description

- 3 Hinge
- 1 Lockset
- 1 Closer

Part Description

- Full Mortise - Standard - 4-1/2"x4-1/2"
- Ball Bearing
- Mortise - Non-Electrified - Store (F07) -
Escutcheon - Knob
- Surface - Push Side - Track

Non-Secure Side



Opening Remarks:

Issue Comments:

LO1: Lock missing/damaged/not securely fastened
 Comments: Faceplate
 Issue Status: Non-Compliant

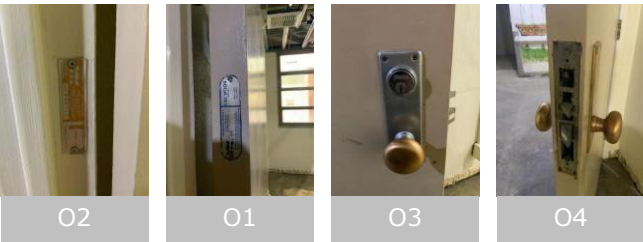

Building: SNF

Non-Compliant
Level: 419

Mark: 419-C100

Secure Side

Description: 7' 4" x 6' 8" x 1 3/4" WD.G Wood HM.3F.M Hollow Metal FR-20

Issue Codes: **D2**
Hardware Set #: 45.10.69.5.T.SV.KP.EG.MHO

Qty	Type	Description	Part Description
6	Hinge		Full Mortise - Standard - 5"x4-1/2" - Ball Bearing
2	Exit Device		Surface Vertical Rod - Exit Only
2	Mag Hold Open		Surface - Medium Duty (Traffic) - Model
2	Closer		Surface - Push Side - Track
2	Plate		Plates - Kick Plate
2	Plate		Guards - Edge Guards
1	Threshold		Saddle

Non-Secure Side

Opening Remarks:
Issue Comments:

D2: Door damaged (bent, dented, delaminating)

Comments:

Corrective Action: Replace

Issue Status: Non-Compliant



O1



O2



D2-1

Building: SNF

Non-Compliant
Level: 420

Mark: 420-101A

Secure Side

Description: 3' 0" x 6' 8" x 1 3/4" WD.G Wood HM.3F.M Hollow Metal FR-20

Issue Codes: **D2, F4**
Hardware Set #: 56.38M.69.7

Qty Type Description

- 3 Hinge
- 1 Lockset
- 1 Closer

Part Description

- Full Mortise - Standard - 4-1/2"x4-1/2"
- Ball Bearing
- Mortise - Non-Electrified - CLASSROOM
SECURITY
- Surface - Push Side - Track

Non-Secure Side

Opening Remarks:
Issue Comments:

D2: Door damaged (bent, dented, delaminating)

Comments:

Corrective Action: Replace

Issue Status: Non-Compliant

F4: Missing/painted/illegible label

Comments: Painted

Issue Status: Non-Compliant



01



02



03



04



05



D2-1



D2-2

Building: SNF

Non-Compliant
Level: 420

Mark: 420-101B

Secure Side

Description: 3' 0" x 6' 8" x 1 3/4" WD.G Wood HM.3F.M Hollow Metal FR-20

Issue Codes: **D2, D9, F4**
Hardware Set #: 56.38M.69.7.WP

Qty	Type	Description	Part Description
3	Hinge		Full Mortise - Standard - 4-1/2"x4-1/2" - Ball Bearing
1	Lockset		Mortise - Non-Electrified - CLASSROOM SECURITY
1	Closer		Surface - Push Side - Track
1	Plate		Wrap around

Non-Secure Side

Opening Remarks:
Issue Comments:

D2: Door damaged (bent, dented, delaminating)

Comments:

Issue Status: Non-Compliant

D9: Improper field modification or repair

Comments:

Corrective Action: Replace

Issue Status: Non-Compliant

F4: Missing/painted/illegible label

Comments: Painted

Issue Status: Non-Compliant



D9-1



D2-1

Building: SNF

Non-Compliant
Level: 420

Mark: 420-102

Secure Side

Description: 2' 6" x 6' 8" x 1 3/4" WD.F Wood HM.TR.M Hollow Metal FR-20

Issue Codes: **D2, F4**
Hardware Set #: 56.38M.50.4(4x4).

Qty	Type	Description	Part Description
3	Hinge		Full Mortise - Standard - 4"x4"
1	Lockset		Mortise - Non-Electrified - CLASSROOM SECURITY

Non-Secure Side

Opening Remarks:
Issue Comments:

D2: Door damaged (bent, dented, delaminating)

Comments:

Corrective Action: Replace

Issue Status: Non-Compliant

F4: Missing/painted/illegible label

Comments: Missing

Issue Status: Non-Compliant

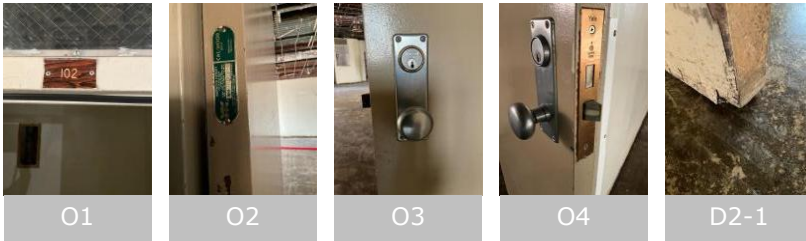

Building: SNF

Non-Compliant
Level: 420

Mark: 420-104A

Secure Side

Description: 3' 0" x 6' 8" x 1 3/4" WD.G Wood HM.3F.M Hollow Metal FR-20

Issue Codes: D9, F4

Hardware Set #: 56.04M.69.7.KP.WP

Qty	Type	Description	Part Description
3	Hinge		Full Mortise - Standard - 4-1/2"x4-1/2" - Ball Bearing
1	Lockset		Mortise - Non-Electrified - Store (F07) - Escutcheon - Knob
1	Closer		Surface - Push Side - Track
1	Plate		Plates - Kick Plate
1	Plate		Wrap around

Non-Secure Side

Opening Remarks:
Issue Comments:

D9: Improper field modification or repair
 Comments:
 Corrective Action: Replace
 Issue Status: Non-Compliant

F4: Missing/painted/illegible label
 Comments: Painted
 Issue Status: Non-Compliant

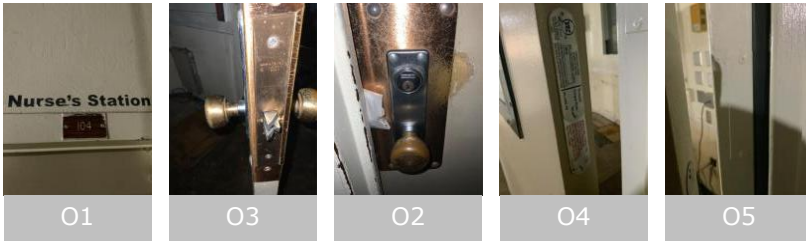

Building: SNF

Non-Compliant
Level: 420

Mark: 420-108

Secure Side

Description: 3' 0" x 6' 8" x 1 3/4" HM.F Hollow Metal HM.3F.M Hollow Metal FR-90

Issue Codes: **D2**
Hardware Set #: 26.04M.69.7.SW.

Qty	Type	Description	Part Description
3	Hinge		Full Mortise - Standard - 4-1/2"x4-1/2" - Ball Bearing
1	Lockset		Mortise - Non-Electrified - Store (F07) - Escutcheon - Knob
1	Closer		Surface - Push Side - Track
1	Sweep		Brush

Non-Secure Side

Opening Remarks:
Issue Comments:

D2: Door damaged (bent, dented, delaminating)
 Comments:
 Corrective Action: Replace
 Issue Status: Non-Compliant



O1



O2



D2-1

Building: SNF

Non-Compliant
Level: 420

Mark: 420-109

Secure Side

Description: 4' 8" x 6' 8" x 1 3/4" WD.F Wood HM.3F.M Hollow Metal FR-60

Issue Codes: **D2, F4**
Hardware Set #: 56.04M.69.7.MF

Qty	Type	Description	Part Description
6	Hinge		Full Mortise - Standard - 4-1/2"x4-1/2" - Ball Bearing
1	Bolt		Concealed - Lever Extension
1	Lockset		Mortise - Non-Electrified - Store (F07) - Escutcheon - Knob
2	Closer		Surface - Push Side - Track

Non-Secure Side

Opening Remarks:
Issue Comments:

D2: Door damaged (bent, dented, delaminating)

Comments:

Corrective Action: Replace

Issue Status: Non-Compliant

F4: Missing/painted/illegible label

Comments: Missing

Issue Status: Non-Compliant



01



02



03



04



D2-1



D2-2

Building: SNF

Non-Compliant

Level: 420

Mark: 420-110

Secure Side

Description: 2' 6" x 6' 8" x 1 3/4" WD.F Wood HM.3F.M Hollow Metal FR-20



Issue Codes: D2, F4

Hardware Set #: 56.04M.69.7.

Qty Type Description

- 3 Hinge
- 1 Lockset
- 1 Closer

Part Description

- Full Mortise - Standard - 4-1/2"x4-1/2" - Ball Bearing
- Mortise - Non-Electrified - Store (F07) - Escutcheon - Knob
- Surface - Push Side - Track

Non-Secure Side



Opening Remarks:

Issue Comments:

D2: Door damaged (bent, dented, delaminating)

Comments:

Corrective Action: Replace

Issue Status: Non-Compliant

F4: Missing/painted/illegible label

Comments: Painted

Issue Status: Non-Compliant



O1



O2



O3



O4



O5



D2-1

Building: SNF

Non-Compliant
Level: 420

Mark: 420-111

Secure Side

Description: 3' 0" x 6' 8" x 1 3/4" WD.F Wood HM.TR.M Hollow Metal FR-20

Issue Codes: D2, D9, F4

Hardware Set #: 56.04M.69.5.WP

Qty	Type	Description	Part Description
3	Hinge		Full Mortise - Standard - 5"x4-1/2" - Ball Bearing
1	Lockset		Mortise - Non-Electrified - Store (F07) - Escutcheon - Knob
1	Closer		Surface - Push Side - Track
1	Plate		Wrap around

Non-Secure Side

Opening Remarks:
Issue Comments:

D2: Door damaged (bent, dented, delaminating)

Comments:

Corrective Action: Replace

Issue Status: Non-Compliant

D9: Improper field modification or repair

Comments:

Corrective Action: Replace

Issue Status: Non-Compliant

F4: Missing/painted/illegible label

Comments: Missing

Issue Status: Non-Compliant



O1



O2



O3



O4



D9-1



D2-1

Building: SNF

Non-Compliant
Level: 420

Mark: 420-112

Secure Side

Description: 3' 8" x 6' 8" x 1 3/4" WD.F Wood HM.3F.M Hollow Metal FR-20

Issue Codes: D9, F4

Hardware Set #: 55.95HL/03.69.5.KP.WP

Qty	Type	Description	Part Description
3	Hinge		Full Mortise - Standard - 5"x4-1/2" - Ball Bearing
1	Lockset		Cylindrical - Non-Electrified - Passage (F75) - Hospital Latch
1	Lockset		Deadbolt - Mortise - Small Body Deadbolt - Double Cylinder
1	Closer		Surface - Push Side - Track
1	Plate		Plates - Kick Plate
1	Plate		Wrap around

Non-Secure Side

Opening Remarks:
Issue Comments:

D9: Improper field modification or repair
 Comments:
 Corrective Action: Replace
 Issue Status: Non-Compliant

F4: Missing/painted/illegible label
 Comments: Missing
 Issue Status: Non-Compliant

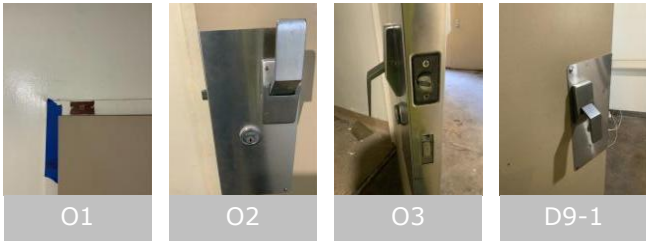

Building: SNF

Non-Compliant
Level: 420

Mark: 420-113

Secure Side

Description: 3' 0" x 6' 8" x 1 3/4" WD.F Wood HM.3F.M Hollow Metal FR-20

Issue Codes: **D2, F4**
Hardware Set #: 55.37M.69.7.WP

Qty	Type	Description	Part Description
3	Hinge		Full Mortise - Standard - 4-1/2"x4-1/2" - Ball Bearing
1	Lockset		Mortise - Non-Electrified - Class (F05) - Escutcheon - Knob
1	Closer		Surface - Push Side - Track
1	Plate		Wrap around

Non-Secure Side

Opening Remarks:
Issue Comments:

D2: Door damaged (bent, dented, delaminating)

Comments:

Corrective Action: Replace

Issue Status: Non-Compliant

F4: Missing/painted/illegible label

Comments: Missing

Issue Status: Non-Compliant

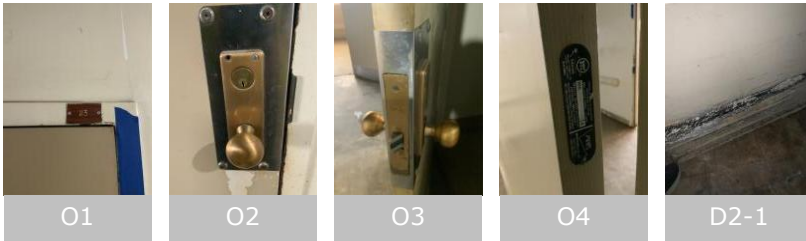

Building: SNF

Compliant

Level: 420

Mark: 420-114

Secure Side

Description: 3' 0" x 6' 8" x 1 3/4" WD.F Wood HM.3F.M Hollow Metal FR-20



Hardware Set #: 56.04M.69.5.

Qty Type Description

- 3 Hinge
- 1 Lockset
- 1 Closer

Part Description

- Full Mortise - Standard - 5"x4-1/2" - Ball Bearing
- Mortise - Non-Electrified - Store (F07) - Escutcheon - Knob
- Surface - Push Side - Track

Non-Secure Side



Opening Remarks:

Issue Comments:



O1



O2



O3



O4

Building: SNF

Non-Compliant
Level: 420

Mark: 420-115

Secure Side

Description: 3' 8" x 6' 8" x 1 3/4" WD.F Wood HM.3F.M Hollow Metal FR-20

Issue Codes: D2, F4

Hardware Set #: 56.04M.69.5.KP.WP

Qty	Type	Description	Part Description
3	Hinge		Full Mortise - Standard - 5"x4-1/2" - Ball Bearing
1	Lockset		Mortise - Non-Electrified - Store (F07) - Escutcheon - Knob
1	Closer		Surface - Push Side - Track
1	Plate		Plates - Kick Plate
1	Plate		Wrap around

Non-Secure Side

Opening Remarks:
Issue Comments:

D2: Door damaged (bent, dented, delaminating)

Comments:

Corrective Action: Replace

Issue Status: Non-Compliant

F4: Missing/painted/illegible label

Comments: Missing

Issue Status: Non-Compliant



Building: SNF

Non-Compliant
Level: 420

Mark: 420-116

Secure Side

Description: 3' 8" x 6' 8" x 1 3/4" WD.F Wood HM.3F.M Hollow Metal FR-20

Issue Codes: **D2, D9, F4**
Hardware Set #: 55.37M.69.5.KP.WP.MHO

Qty	Type	Description	Part Description
3	Hinge		Full Mortise - Standard - 5"x4-1/2" - Ball Bearing
1	Lockset		Mortise - Non-Electrified - Class (F05) - Escutcheon - Knob
1	Mag Hold Open		Surface - Medium Duty (Traffic) - Model
1	Closer		Surface - Push Side - Track
1	Plate		Plates - Kick Plate
1	Plate		Wrap around

Non-Secure Side

Opening Remarks:
Issue Comments:

D2: Door damaged (bent, dented, delaminating)

Comments:

Issue Status: Non-Compliant

D9: Improper field modification or repair

Comments:

Corrective Action: Replace

Issue Status: Non-Compliant

F4: Missing/painted/illegible label

Comments: Missing

Issue Status: Non-Compliant

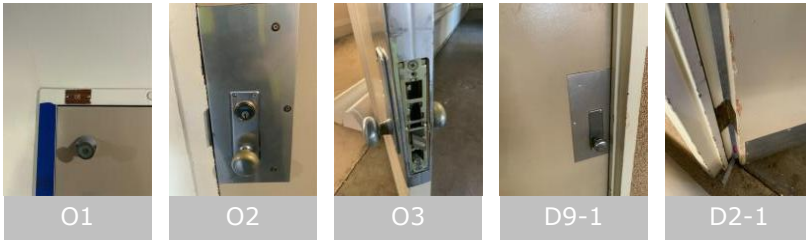

Building: SNF

Non-Compliant
Level: 420

Mark: 420-117

Secure Side

Description: 3' 8" x 6' 8" x 1 3/4" WD.F Wood HM.3F.M Hollow Metal FR-20

Issue Codes: D9, F4

Hardware Set #: 55.37M.69.5.KP.WP.MHO

Qty	Type	Description	Part Description
3	Hinge		Full Mortise - Standard - 5"x4-1/2" - Ball Bearing
1	Lockset		Mortise - Non-Electrified - Class (F05) - Escutcheon - Knob
1	Mag Hold Open		Surface - Medium Duty (Traffic) - Model
1	Closer		Surface - Push Side - Track
1	Plate		Plates - Kick Plate
1	Plate		Wrap around

Non-Secure Side

Opening Remarks:
Issue Comments:

- D9: Improper field modification or repair
 Comments:
 Corrective Action: Replace
 Issue Status: Non-Compliant
- F4: Missing/painted/illegible label
 Comments: Missing
 Issue Status: Non-Compliant

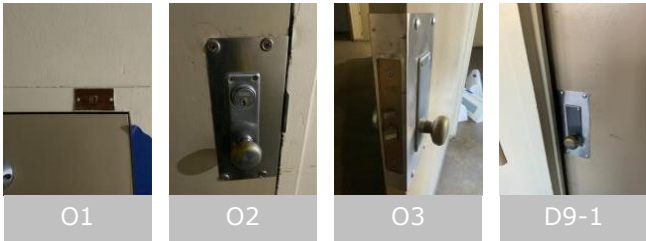

Building: SNF

Non-Compliant
Level: 420

Mark: 420-118

Secure Side

Description: 3' 8" x 6' 8" x 1 3/4" WD.F Wood HM.3F.M Hollow Metal FR-20

Issue Codes: D9, F4

Hardware Set #: 55.37M.69.5.KP.WP.MHO

Qty	Type	Description	Part Description
3	Hinge		Full Mortise - Standard - 5"x4-1/2" - Ball Bearing
1	Lockset		Mortise - Non-Electrified - Class (F05) - Escutcheon - Knob
1	Mag Hold Open		Surface - Medium Duty (Traffic) - Model
1	Closer		Surface - Push Side - Track
1	Plate		Plates - Kick Plate
1	Plate		Wrap around

Non-Secure Side

Opening Remarks:
Issue Comments:

D9: Improper field modification or repair
 Comments:
 Corrective Action: Replace
 Issue Status: Non-Compliant

F4: Missing/painted/illegible label
 Comments: Missing
 Issue Status: Non-Compliant

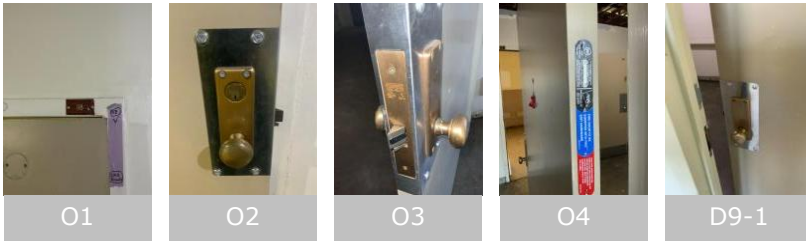

Building: SNF

Non-Compliant
Level: 420

Mark: 420-121

Secure Side

Description: 3' 0" x 6' 8" x 1 3/4" WD.F Wood HM.3F.M Hollow Metal FR-20

Issue Codes: **D2**
Hardware Set #: 56.04M.69.4(4")(5)

Qty	Type	Description	Part Description
3	Hinge		Full Mortise - Standard - 4"x4"
1	Lockset		Mortise - Non-Electrified - Store (F07) - Escutcheon - Knob
1	Closer		Surface - Push Side - Track

Non-Secure Side

Opening Remarks:
Issue Comments:

D2: Door damaged (bent, dented, delaminating)

Comments:

Corrective Action: Replace

Issue Status: Non-Compliant



Building: SNF

Non-Compliant
Level: 420

Mark: 420-122

Secure Side

Description: 3' 0" x 6' 8" x 1 3/4" WD.F Wood HM.3F.M Hollow Metal FR-20

Issue Codes: **D2, F4, O5**
Hardware Set #: 56.04M.69.4(4")(4)

Qty	Type	Description	Part Description
3	Hinge		Full Mortise - Standard - 4"x4"
1	Lockset		Mortise - Non-Electrified - Store (F07) - Escutcheon - Knob
1	Closer		Surface - Push Side - Track

Non-Secure Side

Opening Remarks:
Issue Comments:

- D2: Door damaged (bent, dented, delaminating)
 Comments:
 Issue Status: Non-Compliant
- F4: Missing/painted/illegible label
 Comments: Painted
 Issue Status: Non-Compliant
- O5: Door drags on floor, rubs frame/rubs other door
 Comments: Door rubs frame at top, strike side
 Issue Status: Non-Compliant



O4



O1



O2



O5



O3



O5-1



D2-1



D2-2

Building: SNF

Non-Compliant
Level: 420

Mark: 420-124

Secure Side

Description: 3' 8" x 6' 8" x 1 3/4" WD.F Wood HM.3F.M Hollow Metal FR-20

Issue Codes: **D2, D9, F4, O5**
Hardware Set #: 55.95HL/03.69.5.KP.WP

Qty	Type	Description	Part Description
3	Hinge		Full Mortise - Standard - 5"x4-1/2" - Ball Bearing
1	Lockset		Cylindrical - Non-Electrified - Passage (F75) - Hospital Latch
1	Lockset		Deadbolt - Mortise - Small Body Deadbolt - Double Cylinder
1	Closer		Surface - Push Side - Track
1	Plate		Plates - Kick Plate
1	Plate		Wrap around

Non-Secure Side

Opening Remarks:
Issue Comments:

D2: Door damaged (bent, dented, delaminating)

Comments:

Corrective Action: Replace

Issue Status: Non-Compliant

D9: Improper field modification or repair

Comments:

Issue Status: Non-Compliant

F4: Missing/painted/illegible label

Comments: Missing

Issue Status: Non-Compliant

O5: Door drags on floor, rubs frame/rubs other door

Comments: Wrap plate rubs frame

Issue Status: Non-Compliant



O1



O4



O2



O3



O5



D2-2



D2-1



D9-1

Building: SNF

Non-Compliant
Level: 420

Mark: 420-125

Secure Side

Description: 3' 0" x 6' 8" x 1 3/4" WD.F Wood HM.3F.M Hollow Metal FR-20

Issue Codes: **D2, D3, D9, F4, O5**
Hardware Set #: 55.95HL/03.69.5.KP.WP

Qty	Type	Description	Part Description
3	Hinge		Full Mortise - Standard - 5"x4-1/2" - Ball Bearing
1	Lockset		Cylindrical - Non-Electrified - Passage (F75) - Hospital Latch
1	Lockset		Deadbolt - Mortise - Small Body Deadbolt - Double Cylinder
1	Closer		Surface - Push Side - Track
1	Plate		Plates - Kick Plate
1	Plate		Wrap around

Non-Secure Side

Opening Remarks:
Issue Comments:

- D2: Door damaged (bent, dented, delaminating)
 Comments:
 Corrective Action: Replace
 Issue Status: Non-Compliant
- D3: Missing/painted/illegible label
 Comments: Label has been removed
 Issue Status: Non-Compliant
- D9: Improper field modification or repair
 Comments:
 Issue Status: Non-Compliant
- F4: Missing/painted/illegible label
 Comments: Painted
 Issue Status: Non-Compliant
- O5: Door drags on floor, rubs frame/rubs other door
 Comments: Magh rap plate rubs frame
 Issue Status: Non-Compliant



O1



O2



O3



O4



O5



D2-1



D2-2



D9-1

Building: SNF

Non-Compliant
Level: 420

Mark: 420-126

Secure Side

Description: 3' 0" x 6' 8" x 1 3/4" WD.F Wood HM.3F.M Hollow Metal FR-20

Issue Codes: **D2, D9**
Hardware Set #: 56.04M.69.4(4")

Qty	Type	Description	Part Description
3	Hinge		Full Mortise - Standard - 4"x4"
1	Lockset		Mortise - Non-Electrified - Store (F07) - Escutcheon - Knob
1	Closer		Surface - Push Side - Track

Non-Secure Side

Opening Remarks:
Issue Comments:

D2: Door damaged (bent, dented, delaminating)

Comments:

Corrective Action: Repair

Issue Status: Non-Compliant

D9: Improper field modification or repair

Comments:

Issue Status: Non-Compliant



Building: SNF

Non-Compliant
Level: 420

Mark: 420-127

Secure Side

Description: 3' 8" x 6' 8" x 1 3/4" WD.F Wood HM.3F.M Hollow Metal FR-20

Issue Codes: **D2, D9, F4**
Hardware Set #: 56.05M.69.5.KP.WP

Qty	Type	Description	Part Description
3	Hinge		Full Mortise - Standard - 5"x4-1/2" - Ball Bearing
1	Lockset		Mortise - Non-Electrified - Ent/Off (F04) - Escutcheon - Knob
1	Closer		Surface - Push Side - Track
1	Plate		Plates - Kick Plate
1	Plate		Wrap around

Non-Secure Side

Opening Remarks:
Issue Comments:

D2: Door damaged (bent, dented, delaminating)

Comments:

Corrective Action: Replace

Issue Status: Non-Compliant

D9: Improper field modification or repair

Comments:

Issue Status: Non-Compliant

F4: Missing/painted/illegible label

Comments: Missing

Issue Status: Non-Compliant



O1



O2



O3



O4



D2-1



D2-2



D9-1

Building: SNF

Non-Compliant
Level: 420

Mark: 420-129

Secure Side

Description: 3' 8" x 6' 8" x 1 3/4" WD.F Wood HM.3F.M Hollow Metal FR-20

Issue Codes: **D2, D3, D9, F4, OT**
Hardware Set #: 56.05M.69.5.KP.WP.MHO

Qty	Type	Description	Part Description
3	Hinge		Full Mortise - Standard - 5"x4-1/2" - Ball Bearing
1	Lockset		Mortise - Non-Electrified - Ent/Off (F04) - Escutcheon - Knob
1	Mag Hold Open		Surface - Medium Duty (Traffic) - Model
1	Closer		Surface - Push Side - Track
1	Plate		Plates - Kick Plate
1	Plate		Wrap around

Non-Secure Side

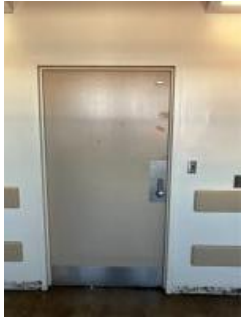
Opening Remarks:
Issue Comments:

D2: Door damaged (bent, dented, delaminating)

Comments:

Issue Status: Non-Compliant

D3: Missing/painted/illegible label

Comments: Michael has been removed

Corrective Action: Replace

Issue Status: Non-Compliant

D9: Improper field modification or repair

Comments:

Issue Status: Non-Compliant

F4: Missing/painted/illegible label

Comments: Missing

Issue Status: Non-Compliant

OT: Mag Hold Open

Comments: Missing wall plate

Issue Status: Non-Compliant



O1



O2



O3



O4



D3-1



D9-1



D2-1



D2-2

Building: SNF

Non-Compliant
Level: 420

Mark: 420-130

Secure Side

Description: 3' 8" x 6' 8" x 1 3/4" WD.F Wood HM.3F.M Hollow Metal FR-20

Issue Codes: **D2, D3, D9, F4**
Hardware Set #: 56.05M.69.5.KP.WP.MHO

Qty	Type	Description	Part Description
3	Hinge		Full Mortise - Standard - 5"x4-1/2" - Ball Bearing
1	Lockset		Mortise - Non-Electrified - Ent/Off (F04) - Escutcheon - Knob
1	Mag Hold Open		Surface - Medium Duty (Traffic) - Model
1	Closer		Surface - Push Side - Track
1	Plate		Plates - Kick Plate
1	Plate		Wrap around

Non-Secure Side

Opening Remarks:
Issue Comments:

- D2: Door damaged (bent, dented, delaminating)
 Comments: Split hinge
 Issue Status: Non-Compliant
- D3: Missing/painted/illegible label
 Comments: Label has been removed
 Issue Status: Non-Compliant
- D9: Improper field modification or repair
 Comments:
 Issue Status: Non-Compliant
- F4: Missing/painted/illegible label
 Comments: Missing
 Issue Status: Non-Compliant



O1



O2



O3



O4



D2-1



D9-1

Building: SNF

Non-Compliant

Level: 420

Mark: 420-132

Secure Side

Description: 3' 0" x 6' 8" x 1 3/4" WD.F Wood HM.3F.M Hollow Metal FR-20



Issue Codes: F4

Hardware Set #: 56.04M.69.7.

Qty Type Description

- 3 Hinge
- 1 Lockset
- 1 Closer

Part Description

- Full Mortise - Standard - 4-1/2"x4-1/2" - Ball Bearing
- Mortise - Non-Electrified - Store (F07) - Escutcheon - Knob
- Surface - Push Side - Track

Non-Secure Side



Opening Remarks:

Issue Comments:

F4: Missing/painted/illegible label
 Comments: Painted
 Issue Status: Non-Compliant

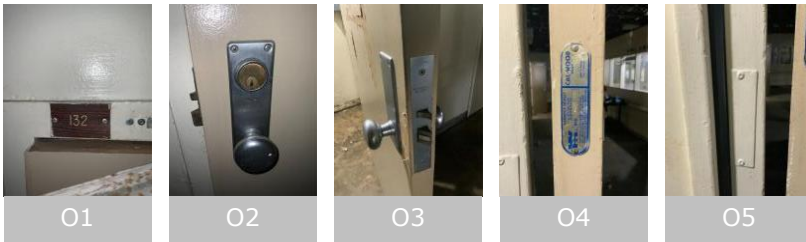

Building: SNF

Non-Compliant
Level: 420

Mark: 420-133

Secure Side

Description: 3' 8" x 6' 8" x 1 3/4" WD.F Wood HM.3F.M Hollow Metal FR-20

Issue Codes: **D9, F4**
Hardware Set #: 56.38M.69.5.KP.WP

Qty	Type	Description	Part Description
3	Hinge		Full Mortise - Standard - 5"x4-1/2" - Ball Bearing
1	Lockset		Mortise - Non-Electrified - CLASSROOM SECURITY
1	Closer		Surface - Push Side - Track
1	Plate		Plates - Kick Plate
1	Plate		Wrap around

Non-Secure Side

Opening Remarks:
Issue Comments:

D9: Improper field modification or repair
 Comments:
 Corrective Action: Replace
 Issue Status: Non-Compliant

F4: Missing/painted/illegible label
 Comments: Missing
 Issue Status: Non-Compliant



Building: SNF

Non-Compliant
Level: 420

Mark: 420-134

Secure Side

Description: 3' 0" x 6' 8" x 1 3/4" WD.F Wood HM.3F.M Hollow Metal FR-20

Issue Codes: D2, F4

Hardware Set #: 56.38M/03C.69.7

Qty	Type	Description	Part Description
3	Hinge		Full Mortise - Standard - 4-1/2"x4-1/2" - Ball Bearing
1	Lockset		Mortise - Non-Electrified - CLASSROOM SECURITY
1	Lockset		Deadbolt - Cylindrical - Cylinder x thumbturn
1	Closer		Surface - Push Side - Track
1	Plate		Plates - Kick Plate

Non-Secure Side

Opening Remarks:
Issue Comments:

D2: Door damaged (bent, dented, delaminating)

Comments:

Corrective Action: Replace

Issue Status: Non-Compliant

F4: Missing/painted/illegible label

Comments: Painted

Issue Status: Non-Compliant



01



02



03



04

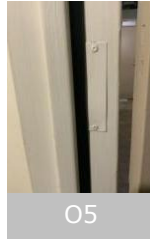

05



D2-1

Building: SNF

Non-Compliant
Level: 420

Mark: 420-135

Secure Side

Description: 3' 8" x 6' 8" x 1 3/4" WD.F Wood HM.3F.M Hollow Metal FR-20

Issue Codes: **D2, D9, F4**
Hardware Set #: 55.95HL/03.69.5.KP.WP

Qty	Type	Description	Part Description
3	Hinge		Full Mortise - Standard - 5"x4-1/2" - Ball Bearing
1	Lockset		Cylindrical - Non-Electrified - Passage (F75) - Hospital Latch
1	Lockset		Deadbolt - Mortise - Small Body Deadbolt - Double Cylinder
1	Closer		Surface - Push Side - Track
1	Plate		Plates - Kick Plate
1	Plate		Wrap around

Non-Secure Side

Opening Remarks:
Issue Comments:

D2: Door damaged (bent, dented, delaminating)

Comments:

Corrective Action: Replace

Issue Status: Non-Compliant

D9: Improper field modification or repair

Comments:

Corrective Action: Replace

Issue Status: Non-Compliant

F4: Missing/painted/illegible label

Comments: Painted

Issue Status: Non-Compliant



O1



O2



O3



O4



O5



O6



D2-1



D9-1

Building: SNF

Non-Compliant
Level: 420

Mark: 420-136

Secure Side

Description: 3' 8" x 6' 8" x 1 3/4" WD.F Wood HM.3F.M Hollow Metal FR-20

Issue Codes: D9, F4

Hardware Set #: 55.37M.69.5.KP.WP.MHO

Qty	Type	Description	Part Description
3	Hinge		Full Mortise - Standard - 5"x4-1/2" - Ball Bearing
1	Lockset		Mortise - Non-Electrified - Class (F05) - Escutcheon - Knob
1	Mag Hold Open		Surface - Medium Duty (Traffic) - Model
1	Closer		Surface - Push Side - Track
1	Plate		Plates - Kick Plate
1	Plate		Wrap around

Non-Secure Side

Opening Remarks:
Issue Comments:

D9: Improper field modification or repair
 Comments:
 Corrective Action: Replace
 Issue Status: Non-Compliant

F4: Missing/painted/illegible label
 Comments: Missing
 Issue Status: Non-Compliant

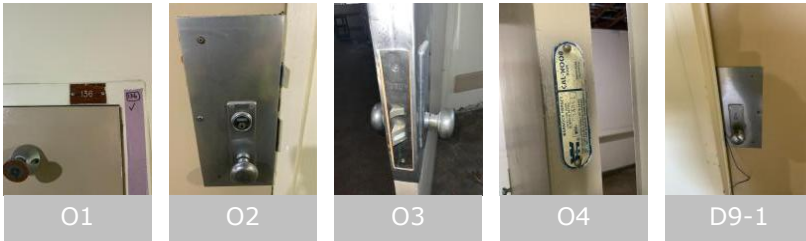

Building: SNF

Non-Compliant
Level: 420

Mark: 420-137

Secure Side

Description: 3' 0" x 6' 8" x 1 3/4" WD.F Wood HM.3F.M Hollow Metal FR-20

Issue Codes: D9, F4

Hardware Set #: 56.04M.69.7.WP

Qty	Type	Description	Part Description
3	Hinge		Full Mortise - Standard - 4-1/2"x4-1/2" - Ball Bearing
1	Lockset		Mortise - Non-Electrified - Store (F07) - Escutcheon - Knob
1	Closer		Surface - Push Side - Track
1	Plate		Wrap around

Non-Secure Side

Opening Remarks:
Issue Comments:

- D9: Improper field modification or repair
Comments:
Corrective Action: Replace
Issue Status: Non-Compliant
- F4: Missing/painted/illegible label
Comments: Painted
Issue Status: Non-Compliant

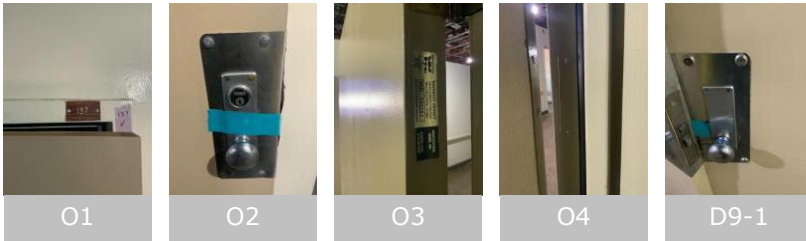

Building: SNF

Non-Compliant
Level: 420

Mark: 420-139

Secure Side

Description: 3' 8" x 6' 8" x 1 3/4" WD.F Wood HM.3F.M Hollow Metal FR-20

Issue Codes: **D2, D9, F4**
Hardware Set #: 56.04M.69.7.KP.WP

Qty	Type	Description	Part Description
3	Hinge		Full Mortise - Standard - 4-1/2"x4-1/2" - Ball Bearing
1	Lockset		Mortise - Non-Electrified - Store (F07) - Escutcheon - Knob
1	Closer		Surface - Push Side - Track
1	Plate		Plates - Kick Plate
1	Plate		Wrap around

Non-Secure Side

Opening Remarks:
Issue Comments:

D2: Door damaged (bent, dented, delaminating)

Comments:

Corrective Action: Replace

Issue Status: Non-Compliant

D9: Improper field modification or repair

Comments:

Corrective Action: Replace

Issue Status: Non-Compliant

F4: Missing/painted/illegible label

Comments: Missing

Issue Status: Non-Compliant



O1



O2



O3



O4



D2-1



D9-1

Building: SNF

Non-Compliant
Level: 420

Mark: 420-140

Secure Side

Description: 3' 0" x 6' 8" x 1 3/4" WD.F Wood HM.3F.M Hollow Metal FR-20

Issue Codes: D9, F4

Hardware Set #: 55.37M.69.7.WP

Qty	Type	Description	Part Description
3	Hinge		Full Mortise - Standard - 4-1/2"x4-1/2" - Ball Bearing
1	Lockset		Mortise - Non-Electrified - Class (F05) - Escutcheon - Knob
1	Closer		Surface - Push Side - Track
1	Plate		Wrap around

Non-Secure Side

Opening Remarks:
Issue Comments:

D9: Improper field modification or repair
 Comments:
 Corrective Action: Replace
 Issue Status: Non-Compliant

F4: Missing/painted/illegible label
 Comments: Painted
 Issue Status: Non-Compliant



Building: SNF

Non-Compliant
Level: 420

Mark: 420-141

Secure Side

Description: 3' 0" x 6' 8" x 1 3/4" WD.F Wood HM.3F.M Hollow Metal FR-20

Issue Codes: D9, F4

Hardware Set #: 56.04M.69.7.KP.WP

Qty	Type	Description	Part Description
3	Hinge		Full Mortise - Standard - 4-1/2"x4-1/2" - Ball Bearing
1	Lockset		Mortise - Non-Electrified - Store (F07) - Escutcheon - Knob
1	Closer		Surface - Push Side - Track
1	Plate		Plates - Kick Plate
1	Plate		Wrap around

Non-Secure Side

Opening Remarks:
Issue Comments:

D9: Improper field modification or repair
 Comments:
 Corrective Action: Replace
 Issue Status: Non-Compliant

F4: Missing/painted/illegible label
 Comments: Painted
 Issue Status: Non-Compliant

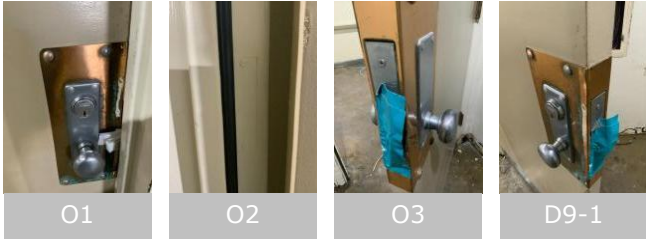

Building: SNF

Non-Compliant
Level: 420

Mark: 420-142

Secure Side

Description: 3' 0" x 6' 8" x 1 3/4" HM.DD Hollow Metal HM.3F.M Hollow Metal FR-20

Issue Codes: D2

Hardware Set #: 56.04M/04C.69.7.MHO

Qty	Type	Description	Part Description
3	Hinge		Full Mortise - Standard - 4-1/2"x4-1/2" - Ball Bearing
1	Lockset		Mortise - Non-Electrified - Store (F07) - Escutcheon - Knob
1	Lockset		Cylindrical - Non-Electrified - Store (F86) - Knob
1	Mag Hold Open		Surface - Medium Duty (Traffic) - Model
1	Closer		Surface - Push Side - Track

Non-Secure Side

Opening Remarks:
Issue Comments:

D2: Door damaged (bent, dented, delaminating)
 Comments: Split door
 Corrective Action: Replace
 Issue Status: Non-Compliant

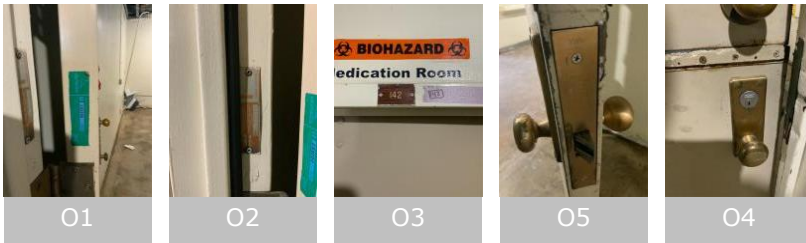

Building: SNF

Non-Compliant
Level: 420

Mark: 420-143

Secure Side

Description: 3' 0" x 6' 8" x 1 3/4" WD.F Wood HM.3F.M Hollow Metal FR-20

Issue Codes: D2, F4

Hardware Set #: 56.38M/03C.69.7.KP

Qty	Type	Description	Part Description
3	Hinge		Full Mortise - Standard - 4-1/2"x4-1/2" - Ball Bearing
1	Lockset		Mortise - Non-Electrified - CLASSROOM SECURITY
1	Lockset		Deadbolt - Cylindrical - Cylinder x thumbturn
1	Closer		Surface - Push Side - Track
1	Plate		Plates - Kick Plate

Non-Secure Side

Opening Remarks:
Issue Comments:

D2: Door damaged (bent, dented, delaminating)

 Comments: Door split
 Corrective Action: Replace
 Issue Status: Non-Compliant

F4: Missing/painted/illegible label

 Comments: Painted
 Issue Status: Non-Compliant

01



02



03



04



05



D2-1

Building: SNF

Non-Compliant
Level: 420

Mark: 420-145

Secure Side

Description: 3' 0" x 6' 8" x 1 3/4" WD.F Wood HM.3F.M Hollow Metal FR-20

Issue Codes: D9

Hardware Set #: 56.04M.69.7.WP

Qty	Type	Description	Part Description
3	Hinge		Full Mortise - Standard - 4-1/2"x4-1/2" - Ball Bearing
1	Lockset		Mortise - Non-Electrified - Store (F07) - Escutcheon - Knob
1	Closer		Surface - Push Side - Track
1	Plate		Wrap around

Non-Secure Side

Opening Remarks:
Issue Comments:

D9: Improper field modification or repair
 Comments:
 Corrective Action: Replace
 Issue Status: Non-Compliant

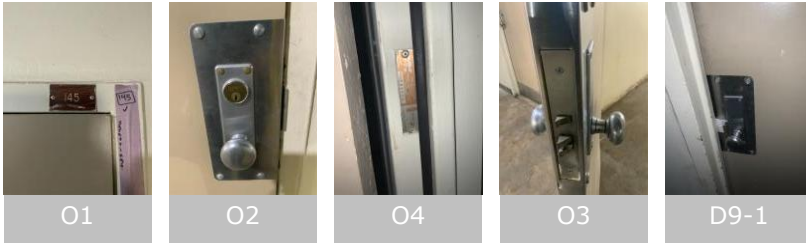

Building: SNF

Non-Compliant
Level: 420

Mark: 420-146

Secure Side

Description: 3' 0" x 6' 8" x 1 3/4" WD.F Wood HM.TR.M Hollow Metal FR-20

Issue Codes: **D9, F4**
Hardware Set #: 56.04M.69.4(4").WP

Qty	Type	Description	Part Description
3	Hinge		Full Mortise - Standard - 4"x4"
1	Lockset		Mortise - Non-Electrified - Store (F07) - Escutcheon - Knob
1	Closer		Surface - Push Side - Track

Non-Secure Side

Opening Remarks:
Issue Comments:

- D9: Improper field modification or repair
 Comments:
 Corrective Action: Replace
 Issue Status: Non-Compliant
- F4: Missing/painted/illegible label
 Comments: Missing
 Issue Status: Non-Compliant

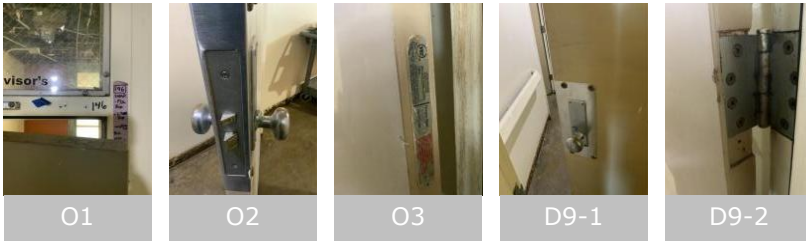

Building: SNF

Non-Compliant
Level: 420

Mark: 420-147

Secure Side

Description: 2' 6" x 6' 8" x 1 3/4" WD.F Wood HM.TR.M Hollow Metal FR-20

Issue Codes: **D9, F4**
Hardware Set #: 56.04M.69.4(4")(2)

Qty	Type	Description	Part Description
3	Hinge		Full Mortise - Standard - 4"x4"
1	Lockset		Mortise - Non-Electrified - Store (F07) - Escutcheon - Knob
1	Closer		Surface - Push Side - Track

Non-Secure Side

Opening Remarks:
Issue Comments:

D9: Improper field modification or repair
 Comments:
 Corrective Action: Replace
 Issue Status: Non-Compliant

F4: Missing/painted/illegible label
 Comments: Missing
 Issue Status: Non-Compliant



Building: SNF

Non-Compliant
Level: 420

Mark: 420-148

Secure Side

Description: 4' 0" x 6' 8" x 1 3/4" WD.F Wood HM.3F.M Hollow Metal FR-20

Issue Codes: **D2, F4**
Hardware Set #: 56.04M.41.4(4").AF.KP.AS

Qty	Type	Description	Part Description
6	Hinge		Full Mortise - Standard - 4"x4"
1	Bolt		Concealed - Automatic
1	Lockset		Mortise - Non-Electrified - Store (F07) - Escutcheon - Knob
2	Closer		Surface - Push Side - Parallel
2	Plate		Plates - Kick Plate
1	Astragal		Flat Astragal - Steel

Non-Secure Side

Opening Remarks:
Issue Comments:

- D2: Door damaged (bent, dented, delaminating)
 Comments: Both doors
 Issue Status: Non-Compliant
- F4: Missing/painted/illegible label
 Comments: Painted
 Issue Status: Non-Compliant



Building: SNF

Non-Compliant
Level: 420

Mark: 420-150

Secure Side

Description: 3' 8" x 6' 8" x 1 3/4" WD.F Wood HM.3F.M Hollow Metal FR-20

Issue Codes: **D2, D3, D9, F4, OT**
Hardware Set #: 56.05M.69.5.KP.WP.MHO

Qty	Type	Description	Part Description
3	Hinge		Full Mortise - Standard - 5"x4-1/2" - Ball Bearing
1	Lockset		Mortise - Non-Electrified - Ent/Off (F04) - Escutcheon - Knob
1	Mag Hold Open		Surface - Medium Duty (Traffic) - Model
1	Closer		Surface - Push Side - Track
1	Plate		Plates - Kick Plate
1	Plate		Wrap around

Non-Secure Side

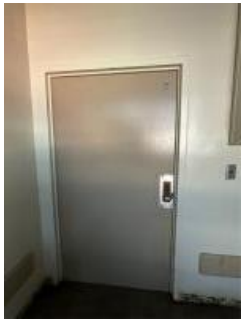
Opening Remarks:
Issue Comments:

- D2: Door damaged (bent, dented, delaminating)
Comments:
Issue Status: Non-Compliant
- D3: Missing/painted/illegible label
Comments: Missing
Issue Status: Non-Compliant
- D9: Improper field modification or repair
Comments:
Issue Status: Non-Compliant
- F4: Missing/painted/illegible label
Comments: Missing
Issue Status: Non-Compliant
- OT: Mag Hold Open
Comments: Wall plate missing
Issue Status: Non-Compliant



O1



O2



O3



D3-1



D2-1



D2-2



D2-3



OT-1

Building: SNF

Non-Compliant
Level: 420

Mark: 420-152

Secure Side

Description: 3' 8" x 6' 8" x 1 3/4" WD.F Wood HM.3F.M Hollow Metal FR-20

Issue Codes: **D2, D9**
Hardware Set #: 56.05M.69.5.KP.WP.MHO

Qty	Type	Description	Part Description
3	Hinge		Full Mortise - Standard - 5"x4-1/2" - Ball Bearing
1	Lockset		Mortise - Non-Electrified - Ent/Off (F04) - Escutcheon - Knob
1	Mag Hold Open		Surface - Medium Duty (Traffic) - Model
1	Closer		Surface - Push Side - Track
1	Plate		Plates - Kick Plate
1	Plate		Wrap around

Non-Secure Side

Opening Remarks:
Issue Comments:

D2: Door damaged (bent, dented, delaminating)

Comments:

Issue Status: Non-Compliant

D9: Improper field modification or repair

Comments:

Issue Status: Non-Compliant

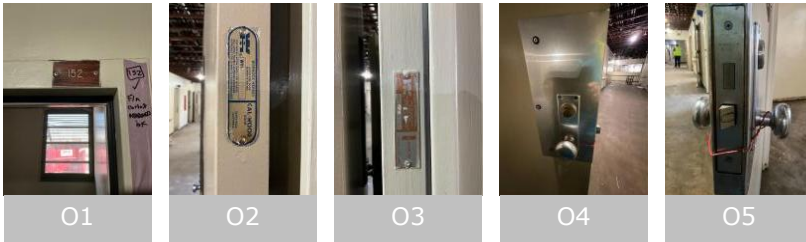

Building: SNF

Non-Compliant
Level: 420

Mark: 420-153

Secure Side

Description: 3' 8" x 6' 8" x 1 3/4" WD.F Wood HM.3F.M Hollow Metal FR-20

Issue Codes: **D2, D3, D9, F4**
Hardware Set #: 56.05M.69.5.KP.WP.MHO

Qty	Type	Description	Part Description
3	Hinge		Full Mortise - Standard - 5"x4-1/2" - Ball Bearing
1	Lockset		Mortise - Non-Electrified - Ent/Off (F04) - Escutcheon - Knob
1	Mag Hold Open		Surface - Medium Duty (Traffic) - Model
1	Closer		Surface - Push Side - Track
1	Plate		Plates - Kick Plate
1	Plate		Wrap around

Non-Secure Side

Opening Remarks:
Issue Comments:

D2: Door damaged (bent, dented, delaminating)

Comments:

Issue Status: Non-Compliant

D3: Missing/painted/illegible label

Comments: Label has been removed

Issue Status: Non-Compliant

D9: Improper field modification or repair

Comments:

Issue Status: Non-Compliant

F4: Missing/painted/illegible label

Comments: Missing

Issue Status: Non-Compliant



Building: SNF

Non-Compliant
Level: 420

Mark: 420-154

Secure Side

Description: 3' 8" x 6' 8" x 1 3/4" WD.F Wood HM.3F.M Hollow Metal FR-20

Issue Codes: **D2, D9, F4**
Hardware Set #: 56.05M.69.5.KP.WP.MHO

Qty	Type	Description	Part Description
3	Hinge		Full Mortise - Standard - 5"x4-1/2" - Ball Bearing
1	Lockset		Mortise - Non-Electrified - Ent/Off (F04) - Escutcheon - Knob
1	Mag Hold Open		Surface - Medium Duty (Traffic) - Model
1	Closer		Surface - Push Side - Track
1	Plate		Plates - Kick Plate
1	Plate		Wrap around

Non-Secure Side

Opening Remarks:
Issue Comments:

D2: Door damaged (bent, dented, delaminating)

Comments:

Issue Status: Non-Compliant

D9: Improper field modification or repair

Comments:

Issue Status: Non-Compliant

F4: Missing/painted/illegible label

Comments: Missing

Issue Status: Non-Compliant



O1



O2



O3



D9-1



D2-1



D2-2

Building: SNF

Non-Compliant
Level: 420

Mark: 420-156

Secure Side

Description: 3' 0" x 6' 8" x 1 3/4" WD.F Wood HM.3F.M Hollow Metal FR-20

Issue Codes: D2, D3, D9, F4

Hardware Set #: 56.04M.69.7.WP

Qty	Type	Description	Part Description
3	Hinge		Full Mortise - Standard - 4-1/2"x4-1/2" - Ball Bearing
1	Lockset		Mortise - Non-Electrified - Store (F07) - Escutcheon - Knob
1	Closer		Surface - Push Side - Track
1	Plate		Wrap around

Non-Secure Side

Opening Remarks:
Issue Comments:

D2: Door damaged (bent, dented, delaminating)

Comments:

Corrective Action: Replace

Issue Status: Non-Compliant

D3: Missing/painted/illegible label

Comments: Missing

Issue Status: Non-Compliant

D9: Improper field modification or repair

Comments:

Issue Status: Non-Compliant

F4: Missing/painted/illegible label

Comments: Missing

Issue Status: Non-Compliant



O1



O2



O3



D9-1



D2-1



D2-2

Building: SNF

Compliant

Level: 420

Mark: 420-157

Secure Side

Description: 3' 0" x 6' 8" x 1 3/4" WD.F Wood HM.3F.M Hollow Metal FR-20



Hardware Set #: 56.04M.69.7.KP

Qty	Type	Description	Part Description
3	Hinge		Full Mortise - Standard - 4-1/2"x4-1/2" - Ball Bearing
1	Lockset		Mortise - Non-Electrified - Store (F07) - Escutcheon - Knob
1	Closer		Surface - Push Side - Track
1	Plate		Plates - Kick Plate

Non-Secure Side



Opening Remarks:

Issue Comments:

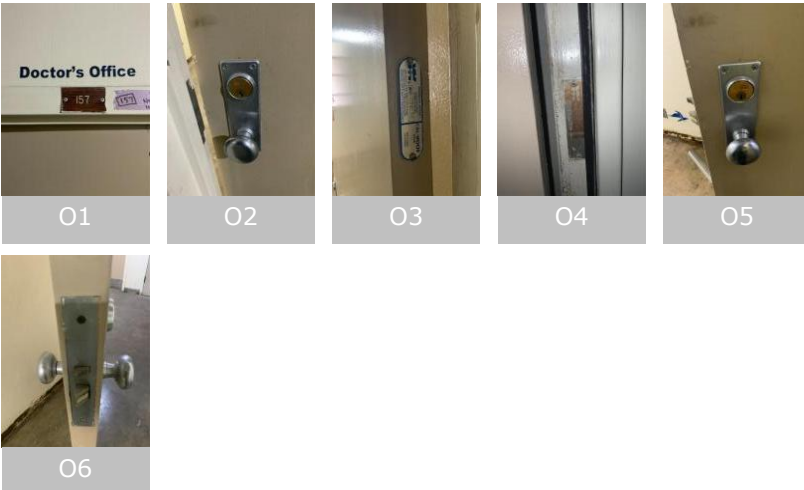

Building: SNF

Non-Compliant
Level: 420

Mark: 420-158

Secure Side

Description: 3' 0" x 6' 8" x 1 3/4" WD.F Wood HM.3F.M Hollow Metal FR-20

Issue Codes: **D2**
Hardware Set #: 56.04M.69.4(4")(3)

Qty	Type	Description	Part Description
3	Hinge		Full Mortise - Standard - 4"x4"
1	Lockset		Mortise - Non-Electrified - Store (F07) - Escutcheon - Knob
1	Closer		Surface - Push Side - Track

Non-Secure Side

Opening Remarks:
Issue Comments:

D2: Door damaged (bent, dented, delaminating)
 Comments: Door split
 Corrective Action: Replace
 Issue Status: Non-Compliant

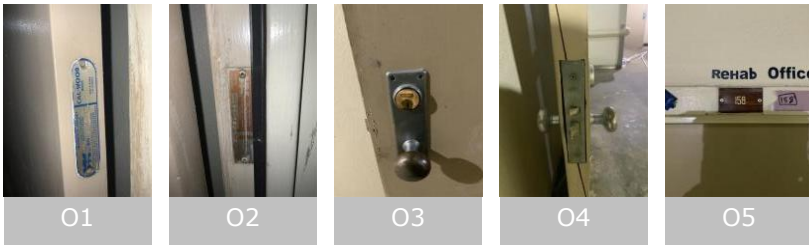

Building: SNF

Non-Compliant
Level: 420

Mark: 420-162

Secure Side

Description: 3' 0" x 6' 8" x 1 3/4" WD.F Wood HM.3F.M Hollow Metal FR-20

Issue Codes: **F4**
Hardware Set #: 56.04M.69.4(4")(6)

Qty	Type	Description	Part Description
3	Hinge		Full Mortise - Standard - 4"x4"
1	Lockset		Mortise - Non-Electrified - Store (F07) - Escutcheon - Knob
1	Closer		Surface - Push Side - Track

Non-Secure Side

Opening Remarks:
Issue Comments:

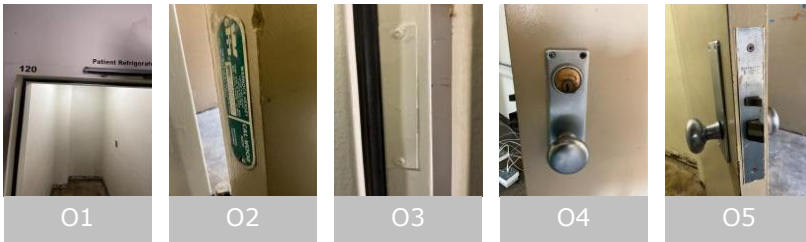
 F4: Missing/painted/illegible label
 Comments: Painted
 Issue Status: Non-Compliant

Building: SNF

Non-Compliant
Level: 420

Mark: 420-C100

Secure Side

Description: 6' 0" x 6' 8" x 1 3/4" WD.G Wood HM.3F.M Hollow Metal FR-20

Issue Codes: **D3, F4, O5**
Hardware Set #: 45.10.69.5.T.SV.KP.EG.MHO

Qty	Type	Description	Part Description
6	Hinge		Full Mortise - Standard - 5"x4-1/2" - Ball Bearing
2	Exit Device		Surface Vertical Rod - Exit Only
2	Mag Hold Open		Surface - Medium Duty (Traffic) - Model
2	Closer		Surface - Push Side - Track
2	Plate		Plates - Kick Plate
2	Plate		Guards - Edge Guards
1	Threshold		Saddle

Non-Secure Side

Opening Remarks:
Issue Comments:

D3: Missing/painted/illegible label
 Comments: 1 door missing label
 Issue Status: Non-Compliant

F4: Missing/painted/illegible label
 Comments: Missing
 Issue Status: Non-Compliant

O5: Door drags on floor, rubs frame/rubs other door
 Comments: 1 door rubs frame
 Issue Status: Non-Compliant



Building: SNF

Non-Compliant
Level: A

Mark: A-103

Secure Side

Description: 3' 0" x 6' 8" x 1 3/4" WD.G Wood HM.TR.M Hollow Metal FR-20

Issue Codes: **D9, F4**
Hardware Set #: 56.04M.69.5.KP.WP

Qty	Type	Description	Part Description
3	Hinge		Full Mortise - Standard - 5"x4-1/2" - Ball Bearing
1	Lockset		Mortise - Non-Electrified - Store (F07) - Escutcheon - Knob
1	Closer		Surface - Push Side - Track
1	Plate		Plates - Kick Plate
1	Plate		Wrap around

Non-Secure Side

Opening Remarks:
Issue Comments:

D9: Improper field modification or repair
 Comments:
 Corrective Action: Replace
 Issue Status: Non-Compliant

F4: Missing/painted/illegible label
 Comments: Missing
 Issue Status: Non-Compliant



D9-1



O1

Building: SNF

Non-Compliant
Level: A

Mark: A-114

Secure Side

Description: 2' 6" x 6' 8" x 1 3/4" WD.L Wood HM.3F.D Hollow Metal FR-20

Issue Codes: **D2, F4**
Hardware Set #: 56.04M.50.4(4x4).

Qty	Type	Description	Part Description
3	Hinge		Full Mortise - Standard - 4"x4"
1	Lockset		Mortise - Non-Electrified - Store (F07) - Escutcheon - Knob

Non-Secure Side

Opening Remarks:
Issue Comments:

D2: Door damaged (bent, dented, delaminating)

Comments:

Corrective Action: Replace

Issue Status: Non-Compliant

F4: Missing/painted/illegible label

Comments: Missing

Issue Status: Non-Compliant

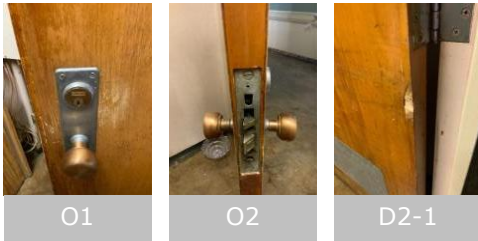

O1

O2

D2-1

Building: SNF

Non-Compliant

Level: A

Mark: A-116

Secure Side

Description: 2' 6" x 6' 8" x 1 3/4" WD.L Wood HM.3F.D Hollow Metal FR-20



Issue Codes: **D2, F4**

Hardware Set #: 56.04M.50.4(4x4).

Qty	Type	Description	Part Description
3	Hinge		Full Mortise - Standard - 4"x4"
1	Lockset		Mortise - Non-Electrified - Store (F07) - Escutcheon - Knob

Non-Secure Side



Opening Remarks:

Issue Comments:

D2: Door damaged (bent, dented, delaminating)

Comments:

Corrective Action: Replace

Issue Status: Non-Compliant

F4: Missing/painted/illegible label

Comments: Missing

Issue Status: Non-Compliant

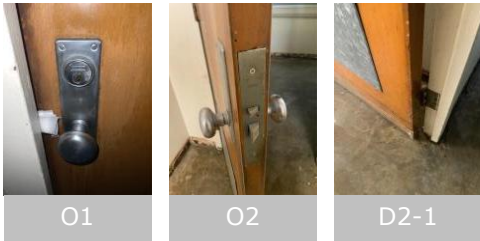

Building: SNF

Non-Compliant
Level: A

Mark: A-118

Secure Side

Description: 2' 6" x 6' 8" x 1 3/4" WD.L Wood HM.TR.M Hollow Metal FR-20

Issue Codes: **D2, F4**
Hardware Set #: 56.04M/03.64.4(4x4).KP.PP

Qty	Type	Description	Part Description
3	Hinge		Full Mortise - Standard - 4"x4"
1	Lockset		Mortise - Non-Electrified - Store (F07) - Escutcheon - Knob
1	Lockset		Deadbolt - Cylindrical - Thumbturn only
1	Push		Push - Push Plates
1	Pull		Pull - Pulls
1	Pot belly		Surface - Pull Side - Regular - Potbelly
1	Plate		Plates - Kick Plate

Non-Secure Side

Opening Remarks:
Issue Comments:

D2: Door damaged (bent, dented, delaminating)

Comments:

Corrective Action: Replace

Issue Status: Non-Compliant

F4: Missing/painted/illegible label

Comments: Missing

Issue Status: Non-Compliant



O1



O2



D2-1

Building: SNF

Non-Compliant

Level: A

Mark: A-119

Secure Side

Description: 3' 6" x 6' 8" x 1 3/4" WD.L Wood HM.TR.M Hollow Metal FR-20



Issue Codes: D2, F4

Hardware Set #: 56.04M.64.5.

Qty Type Description

- 3 Hinge
- 1 Lockset
- 1 Closer

Part Description

- Full Mortise - Standard - 5"x4-1/2" - Ball Bearing
- Mortise - Non-Electrified - Store (F07) - Escutcheon - Knob
- Surface - Pull Side - Regular

Non-Secure Side



Opening Remarks:

Issue Comments:

D2: Door damaged (bent, dented, delaminating)

Comments:

Corrective Action: Replace

Issue Status: Non-Compliant

F4: Missing/painted/illegible label

Comments: Missing

Issue Status: Non-Compliant

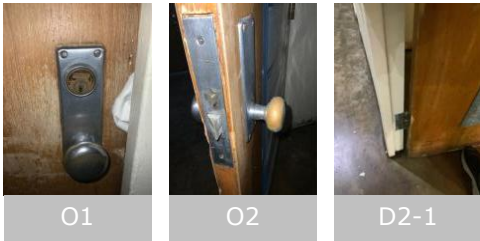

Building: SNF

Non-Compliant
Level: A

Mark: A-122

Secure Side

Description: 2' 6" x 6' 8" x 1 3/4" WD.N6 Wood HM.TR.M Hollow Metal FR-20

Issue Codes: **D2, D3, D9, F4**
Hardware Set #: 56.04M.64.4(4")

Qty	Type	Description	Part Description
3	Hinge		Full Mortise - Standard - 4"x4"
1	Lockset		Mortise - Non-Electrified - Store (F07) - Escutcheon - Knob
1	Closer		Surface - Pull Side - Regular

Non-Secure Side

Opening Remarks:
Issue Comments:

D2: Door damaged (bent, dented, delaminating)

Comments:

Issue Status: Non-Compliant

D3: Missing/painted/illegible label

Comments: Missing label

Issue Status: Non-Compliant

D9: Improper field modification or repair

Comments:

Issue Status: Non-Compliant

F4: Missing/painted/illegible label

Comments: Missing label

Issue Status: Non-Compliant



O1



O2



O3



D2-1



D2-2



D9-1

Building: SNF

Non-Compliant
Level: A

Mark: A-123

Secure Side

Description: 2' 6" x 6' 8" x 1 3/4" WD.F Wood HM.TR.M Hollow Metal FR-20

Issue Codes: **D2, D3, F4**
Hardware Set #: 56.04M.69.4(4")

Qty	Type	Description	Part Description
3	Hinge		Full Mortise - Standard - 4"x4"
1	Lockset		Mortise - Non-Electrified - Store (F07) - Escutcheon - Knob
1	Closer		Surface - Push Side - Track

Non-Secure Side

Opening Remarks:
Issue Comments:

D2: Door damaged (bent, dented, delaminating)

Comments:

Corrective Action: Replace

Issue Status: Non-Compliant

D3: Missing/painted/illegible label

Comments: Missing

Issue Status: Non-Compliant

F4: Missing/painted/illegible label

Comments: Missing

Issue Status: Non-Compliant



O1



O2



O3



O4



O5



D2-1



D2-2

Building: SNF

Non-Compliant
Level: A

Mark: A-124

Secure Side

Description: 2' 6" x 6' 8" x 1 3/4" WD.F Wood HM.TR.M Hollow Metal FR-20

Issue Codes: D2, D3, F4

Hardware Set #: 56.04M.69.4(4").KP

Qty	Type	Description	Part Description
3	Hinge		Full Mortise - Standard - 4"x4"
1	Lockset		Mortise - Non-Electrified - Store (F07) - Escutcheon - Knob
1	Closer		Surface - Push Side - Track
1	Plate		Plates - Kick Plate

Non-Secure Side

Opening Remarks:
Issue Comments:

D2: Door damaged (bent, dented, delaminating)

Comments:

Corrective Action: Replace

Issue Status: Non-Compliant

D3: Missing/painted/illegible label

Comments: Missing

Issue Status: Non-Compliant

F4: Missing/painted/illegible label

Comments: Missing

Issue Status: Non-Compliant

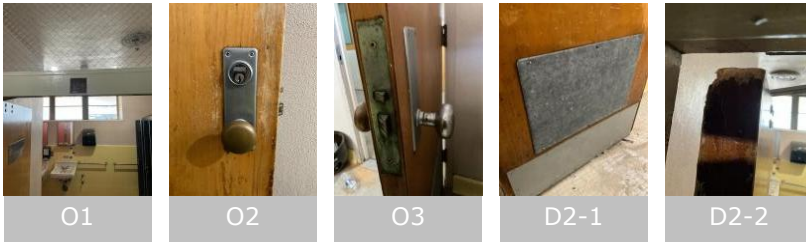

Building: SNF

Non-Compliant

Level: A

Mark: A-136B

Secure Side

Description: 3' 0" x 6' 8" x 1 3/4" WD.F Wood HM.3F.M Hollow Metal FR-60



Issue Codes: D2, F4

Hardware Set #: 56.04M.69.7

Qty Type Description

- 3 Hinge
- 1 Lockset
- 1 Closer

Part Description

- Full Mortise - Standard - 4-1/2"x4-1/2"
- Ball Bearing
- Mortise - Non-Electrified - Store (F07) -
Escutcheon - Knob
- Surface - Push Side - Track

Non-Secure Side



Opening Remarks:

Issue Comments:

D2: Door damaged (bent, dented, delaminating)

Comments:

Issue Status: Non-Compliant

F4: Missing/painted/illegible label

Comments: Painted

Issue Status: Non-Compliant

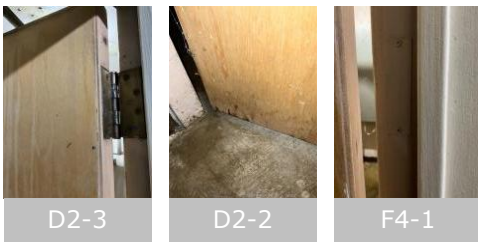
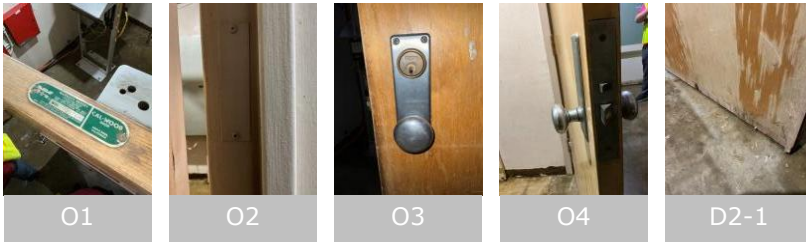

Building: SNF

Non-Compliant
Level: A

Mark: A-136C

Secure Side

Description: 3' 10" x 6' 8" x 1 3/4" WD.G Wood HM.TR.M Hollow Metal FR-20

Issue Codes: D2, F4

Hardware Set #: 56.38M.69.5.KP.AP

Qty	Type	Description	Part Description
3	Hinge		Full Mortise - Standard - 5"x4-1/2" - Ball Bearing
1	Lockset		Mortise - Non-Electrified - CLASSROOM SECURITY
1	Closer		Surface - Push Side - Track
1	Plate		Plates - Kick Plate
1	Plate		Plates - Armor Plate

Non-Secure Side

Opening Remarks:
Issue Comments:

D2: Door damaged (bent, dented, delaminating)

Comments:

Corrective Action: Replace

Issue Status: Non-Compliant

F4: Missing/painted/illegible label

Comments: Missing

Issue Status: Non-Compliant



O1



O2



D2-1



D2-2

Building: SNF

Non-Compliant
Level: A

Mark: A-142B

Secure Side

Description: 3' 0" x 6' 8" x 1 3/4" HM.F Hollow Metal HM.TR.M Hollow Metal FR-20

Issue Codes: **D1, D3, F2, F4**
Hardware Set #: 56.04M.61.5.

Qty Type Description

- 3 Hinge
- 1 Lockset
- 1 Closer

Part Description

- Full Mortise - Standard - 5"x4-1/2" - Ball Bearing
- Mortise - Non-Electrified - Store (F07) - Escutcheon - Knob
- Surface - Push Side - Parallel

Non-Secure Side

Opening Remarks:
Issue Comments:

- D1: Rust-through on door
Comments:
Corrective Action: Replace
Issue Status: Non-Compliant
- D3: Missing/painted/illegible label
Comments: Missing
Issue Status: Non-Compliant
- F2: Damaged/rust through on frame
Comments:
Corrective Action: Replace
Issue Status: Non-Compliant
- F4: Missing/painted/illegible label
Comments: Missing
Issue Status: Non-Compliant



D1-1



F2-1



F2-2

Building: SNF

Non-Compliant
Level: A

Mark: A-143A

Secure Side

Description: 3' 6" x 6' 8" x 1 3/4" WD.G Wood HM.TR.M Hollow Metal FR-20

Issue Codes: **D2, F4**
Hardware Set #: 56.38M.69.5.KP.

Qty	Type	Description	Part Description
3	Hinge		Full Mortise - Standard - 5"x4-1/2" - Ball Bearing
1	Lockset		Mortise - Non-Electrified - CLASSROOM SECURITY
1	Closer		Surface - Push Side - Track
1	Plate		Plates - Kick Plate

Non-Secure Side

Opening Remarks:
Issue Comments:

D2: Door damaged (bent, dented, delaminating)

Comments:

Corrective Action: Replace

Issue Status: Non-Compliant

F4: Missing/painted/illegible label

Comments: Missing

Issue Status: Non-Compliant



O1



O2

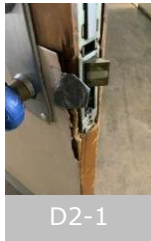

D2-1



D2-2

Building: SNF

Non-Compliant

Level: A

Mark: A-143B

Secure Side

Description: 3' 6" x 6' 8" x 1 3/4" WD.G Wood HM.TR.M Hollow Metal FR-20



Issue Codes: D2, F4

Hardware Set #: 56.38M.69.5.KP.

Qty	Type	Description	Part Description
3	Hinge		Full Mortise - Standard - 5"x4-1/2" - Ball Bearing
1	Lockset		Mortise - Non-Electrified - CLASSROOM SECURITY
1	Closer		Surface - Push Side - Track
1	Plate		Plates - Kick Plate

Non-Secure Side



Opening Remarks:

Issue Comments:

D2: Door damaged (bent, dented, delaminating)

Comments:

Corrective Action: Replace

Issue Status: Non-Compliant

F4: Missing/painted/illegible label

Comments: Missing

Issue Status: Non-Compliant



Building: SNF

Non-Compliant
Level: A

Mark: A-147A

Secure Side

Description: 3' 8" x 6' 8" x 1 3/4" WD.V Wood HM.TR.M Hollow Metal FR-20

Issue Codes: **D2, F4, O5**
Hardware Set #: 56.38M.69.5.AP.PP

Qty	Type	Description	Part Description
3	Hinge		Full Mortise - Standard - 5"x4-1/2" - Ball Bearing
1	Lockset		Mortise - Non-Electrified - CLASSROOM SECURITY
1	Push		Push - Push Plates
1	Pull		Pull - Pulls
1	Closer		Surface - Push Side - Track
1	Plate		Plates - Armor Plate

Non-Secure Side

Opening Remarks:
Issue Comments:

D2: Door damaged (bent, dented, delaminating)

Comments:

Corrective Action: Replace

Issue Status: Non-Compliant

F4: Missing/painted/illegible label

Comments: Missing

Issue Status: Non-Compliant

O5: Door drags on floor, rubs frame/rubs other door

Comments: Rubs on floor

Issue Status: Non-Compliant



O1



O2



D2-1

Building: SNF

Non-Compliant
Level: A

Mark: A-147B

Secure Side

Description: 3' 8" x 6' 8" x 1 3/4" WD.V Wood HM.TR.M Hollow Metal FR-20

Issue Codes: D2, F4

Hardware Set #: 56.38M.69.5.AP.PP

Qty	Type	Description	Part Description
3	Hinge		Full Mortise - Standard - 5"x4-1/2" - Ball Bearing
1	Lockset		Mortise - Non-Electrified - CLASSROOM SECURITY
1	Push		Push - Push Plates
1	Pull		Pull - Pulls
1	Closer		Surface - Push Side - Track
1	Plate		Plates - Armor Plate

Non-Secure Side

Opening Remarks:
Issue Comments:

D2: Door damaged (bent, dented, delaminating)

Comments:

Corrective Action: Replace

Issue Status: Non-Compliant

F4: Missing/painted/illegible label

Comments: Missing

Issue Status: Non-Compliant



Building: SNF

Non-Compliant
Level: A

Mark: A-148A

Secure Side

Description: 3' 8" x 6' 8" x 1 3/4" WD.G Wood HM.TR.M Hollow Metal FR-20

Issue Codes: **D2, F4**
Hardware Set #: 56.38M.69.5.KP.

Qty	Type	Description	Part Description
3	Hinge		Full Mortise - Standard - 5"x4-1/2" - Ball Bearing
1	Lockset		Mortise - Non-Electrified - CLASSROOM SECURITY
1	Closer		Surface - Push Side - Track
1	Plate		Plates - Kick Plate

Non-Secure Side

Opening Remarks:
Issue Comments:

D2: Door damaged (bent, dented, delaminating)

Comments:

Corrective Action: Replace

Issue Status: Non-Compliant

F4: Missing/painted/illegible label

Comments: Missing

Issue Status: Non-Compliant



O1



O2

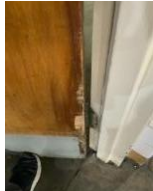

D2-1

Building: SNF

Non-Compliant

Level: A

Mark: A-149

Secure Side

Description: 3' 6" x 6' 8" x 1 3/4" WD.G Wood HM.TR.M Hollow Metal FR-20



Issue Codes: D3, D4, F4

Hardware Set #: 55.04KPL.50.5

Qty Type Description

- 3 Hinge
- 1 Lockset

Part Description

- Full Mortise - Standard - 5"x4-1/2" - Ball Bearing
- Mortise - Non-Electrified - Store (F07) - Lever - Keypad

Non-Secure Side



Opening Remarks:

Issue Comments:

- D3: Missing/painted/illegible label
Comments: Label missing
Corrective Action: Replace
Issue Status: Non-Compliant
- D4: Incorrect/missing/broken glass
Comments: Non-rated glazing
Corrective Action: Replace
Issue Status: Non-Compliant
- F4: Missing/painted/illegible label
Comments: Missing label
Issue Status: Non-Compliant

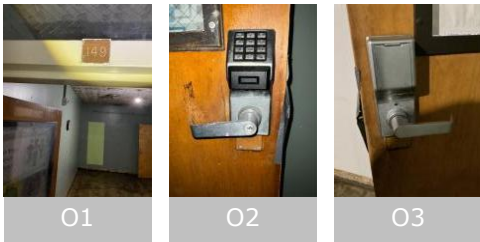

Building: SNF

Non-Compliant

Level: A

Mark: A-151

Secure Side

Description: 3' 0" x 6' 8" x 1 3/4" WD.F Wood HM.TR.M Hollow Metal FR-20



Issue Codes: O5

Hardware Set #: 56.04M.50.4(4x4).

Qty Type Description

- 3 Hinge
- 1 Lockset

Part Description

- Full Mortise - Standard - 4"x4"
- Mortise - Non-Electrified - Store (F07) - Escutcheon - Knob

Non-Secure Side



Opening Remarks:

Issue Comments:

O5: Door drags on floor, rubs frame/rubs other door
 Comments: Rubs on frame
 Issue Status: Non-Compliant



Building: SNF

Non-Compliant
Level: A

Mark: A-159

Secure Side

Description: 3' 0" x 6' 8" x 1 3/4" WD.F Wood HM.TR.M Hollow Metal FR-20

Issue Codes: D2, D3, F4

Hardware Set #: 56.04M.69.4(4")

Qty	Type	Description	Part Description
3	Hinge		Full Mortise - Standard - 4"x4"
1	Lockset		Mortise - Non-Electrified - Store (F07) - Escutcheon - Knob
1	Closer		Surface - Push Side - Track

Non-Secure Side

Opening Remarks:
Issue Comments:

D2: Door damaged (bent, dented, delaminating)

Comments: Damages

Corrective Action: Replace

Issue Status: Non-Compliant

D3: Missing/painted/illegible label

Comments: Missing label

Issue Status: Non-Compliant

F4: Missing/painted/illegible label

Comments: Label missing

Issue Status: Non-Compliant

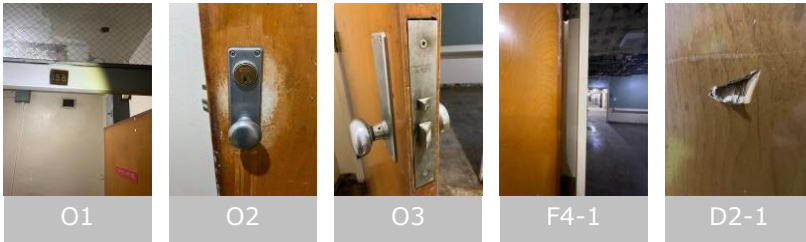

Building: SNF

Non-Compliant
Level: A

Mark: A-160

Secure Side

Description: 3' 6" x 6' 8" x 1 3/4" WD.F Wood HM.TR.M Hollow Metal FR-20

Issue Codes: **D2, D3, F4**
Hardware Set #: 56.04M.50.4(4x4).

Qty	Type	Description	Part Description
3	Hinge		Full Mortise - Standard - 4"x4"
1	Lockset		Mortise - Non-Electrified - Store (F07) - Escutcheon - Knob

Non-Secure Side

Opening Remarks:
Issue Comments:

D2: Door damaged (bent, dented, delaminating)

Comments:

Corrective Action: Replace

Issue Status: Non-Compliant

D3: Missing/painted/illegible label

Comments: Missing

Issue Status: Non-Compliant

F4: Missing/painted/illegible label

Comments: Missing

Issue Status: Non-Compliant



O1



O2



O3



D2-1

Building: SNF

Non-Compliant

Level: A

Mark: A-161

Secure Side

Description: 2' 6" x 6' 8" x 1 3/4" WD.F Wood HM.TR.M Hollow Metal FR-20



Issue Codes: D2, D3, F4

Hardware Set #: 56.04M.50.4(4x4).

Qty	Type	Description	Part Description
3	Hinge		Full Mortise - Standard - 4"x4"
1	Lockset		Mortise - Non-Electrified - Store (F07) - Escutcheon - Knob

Non-Secure Side



Opening Remarks:

Issue Comments:

- D2: Door damaged (bent, dented, delaminating)
 Comments:
 Corrective Action: Replace
 Issue Status: Non-Compliant
- D3: Missing/painted/illegible label
 Comments: missing
 Issue Status: Non-Compliant
- F4: Missing/painted/illegible label
 Comments: Missing
 Issue Status: Non-Compliant

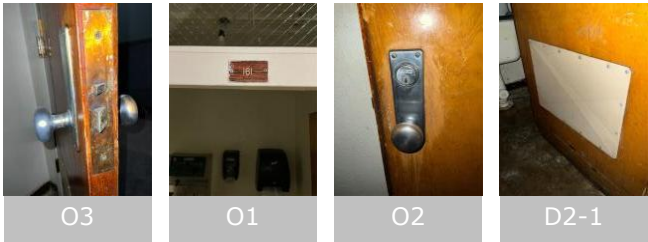

080610 - Door Schedule Report

Project Name: DSH-METROPOLITAN SNF BLDG

Project ID: 196636

OPENING INFORMATION

Mark	Building	Level	Qty	Configuration	Width	Height	Thickness	Fire Rating	Hardware	Comments	Specifier Remarks	Note1	Smart Tag URL
417-101A	SNF	417	1	SG	3' 0"	6' 8"	1 3/4"	20	56.38M.69.7.K P.WP				https://www.openingsstudio.com/AAOS/AAOM/WebView?OP=ID&ID=de792906-e6b9-4557-b6ab-f4b6a8236b18
417-101B	SNF	417	1	AI	6' 0"	7' 0"	1 3/4"		26.38M/99.11P B.5.TH.MF.KP.(1)				https://www.openingsstudio.com/AAOS/AAOM/WebView?OP=ID&ID=321dbac9-c3a7-4292-a2fd-47a07fd63eab
417-101C	SNF	417	1	AI	6' 0"	7' 0"	1 3/4"	None	26.38M/99.11P B.5.MF.KP.AS				https://www.openingsstudio.com/AAOS/AAOM/WebView?OP=ID&ID=6833b3d9-249b-42ba-bf34-ac2bac881861
417-101D	SNF	417	1	SG	3' 6"	7' 0"	1 3/4"	None	26.38M/99.11P B.5/5HS.TH.KP				https://www.openingsstudio.com/AAOS/AAOM/WebView?OP=ID&ID=256b9c75-6f74-4c6b-8c37-b8e93a17babc
417-101E	SNF	417	1	SG	3' 0"	6' 8"	1 3/4"	20	56.38M.69.7.K P.				https://www.openingsstudio.com/AAOS/AAOM/WebView?OP=ID&ID=86abd471-076d-4b7c-9f0d-f046e07ffb2
417-102	SNF	417	1	SG	2' 6"	6' 8"	1 3/4"	60	56.38M.50.4(4x 4).				https://www.openingsstudio.com/AAOS/AAOM/WebView?OP=ID&ID=34b8f18d-a2cb-4c8a-958a-dd540948d149
417-103	SNF	417	1	SG	2' 7"	8' 0"	1"		99.0			Custom door and frame	https://www.openingsstudio.com/AAOS/AAOM/WebView?OP=ID&ID=82b4b5ea-61bb-4cb6-b0d3-063923a6d023
417-104A	SNF	417	1	SG	3' 0"	6' 8"	1 3/4"	20	56.04M.69.7.W P				https://www.openingsstudio.com/AAOS/AAOM/WebView?OP=ID&ID=d9a2442a-dec5-46d8-9f34-205de7bf4845
417-104B	SNF	417	1	SG	3' 0"	6' 8"	1 3/4"		56.38M.50.7/4(4.5SP).MF				https://www.openingsstudio.com/AAOS/AAOM/WebView?OP=ID&ID=501f6895-9295-49f1-b9dc-25f0a881e4c0
417-107A	SNF	417	1	SG	3' 6"	6' 8"	1 3/4"	20	56.38M.69.7.K P.WP				https://www.openingsstudio.com/AAOS/AAOM/WebView?OP=ID&ID=19e36634-f714-4752-b154-ee803c76bc01
417-107B	SNF	417	1	SG	3' 6"	7' 0"	1 3/4"		26.38M.A.69.5. TH.KP.DC.DB				https://www.openingsstudio.com/AAOS/AAOM/WebView?OP=ID&ID=95c9f214-1182-4db7-a8c9-968b59ef71ee
417-108	SNF	417	1	SG	3' 0"	6' 8"	1 3/4"	20	26.38M.69.7.S W.				https://www.openingsstudio.com/AAOS/AAOM/WebView?OP=ID&ID=cf28e355-ca28-4cb9-aa50-5cea9334bbc9
417-109	SNF	417	1	AI	4' 8"	6' 8"	1 3/4"	20	56.04M.69.7.M F				https://www.openingsstudio.com/AAOS/AAOM/WebView?OP=ID&ID=96dd4876-a3d1-4d39-a078-43109eec66b1
417-110	SNF	417	1	SG	2' 6"	6' 8"	1 3/4"	20	56.04M.69.7.W P				https://www.openingsstudio.com/AAOS/AAOM/WebView?OP=ID&ID=7265ee10-5706-41f2-b7ca-29b66c6b6a4b
417-111	SNF	417	1	SG	3' 0"	6' 8"	1 3/4"	20	56.04M.69.7.W P				https://www.openingsstudio.com/AAOS/AAOM/WebView?OP=ID&ID=913ddcca-b00d-4730-b261-f61c1c2a1482
417-112	SNF	417	1	SG	3' 8"	6' 8"	1 3/4"	20	55.95HL/03.69. 5.KP.WP				https://www.openingsstudio.com/AAOS/AAOM/WebView?OP=ID&ID=02fd5bb-60b5-4661-9323-29c3383d02a8
417-113	SNF	417	1	SG	3' 0"	6' 8"	1 3/4"	20	56.38M.69.7.W P				https://www.openingsstudio.com/AAOS/AAOM/WebView?OP=ID&ID=81fcacf-0fe9-44fe-a208-207cac094648
417-114	SNF	417	1	SG	3' 0"	6' 8"	1 3/4"	20	56.04M.69.5.K P.WP				https://www.openingsstudio.com/AAOS/AAOM/WebView?OP=ID&ID=c11b9600-7e02-41b8-aa18-21c2cc4a5412
417-115	SNF	417	1	SG	3' 8"	6' 8"	1 3/4"	20	55.95HL/03.69. 5.KP.WP.MHO				https://www.openingsstudio.com/AAOS/AAOM/WebView?OP=ID&ID=7f37d06b-b879-4261-aae9-1e5bfc2fe5c7
417-116	SNF	417	1	SG	3' 8"	6' 8"	1 3/4"	20	55.95HL/03.69. 5.KP.WP.MHO				https://www.openingsstudio.com/AAOS/AAOM/WebView?OP=ID&ID=02fd257f-11ad-440b-bfc2-e46cd009919b
417-117	SNF	417	1	SG	3' 8"	6' 8"	1 3/4"	20	55.95HL/03.69. 5.KP.WP.MHO				https://www.openingsstudio.com/AAOS/AAOM/WebView?OP=ID&ID=397694c4-f56a-4b8b-89c8-154d4424c263
417-118	SNF	417	1	SG	3' 8"	6' 8"	1 3/4"	20	55.95HL/03.69. 5.KP.WP.MHO				https://www.openingsstudio.com/AAOS/AAOM/WebView?OP=ID&ID=02502ed3-eda4-41ed-9b51-a6752bf36dd0
417-119	SNF	417	1	SG	3' 0"	6' 8"	1 3/4"	20	56.04M.69.7				https://www.openingsstudio.com/AAOS/AAOM/WebView?OP=ID&ID=51964c48-62f2-4c4f-9655-67e9bceb2205

080610 - Door Schedule Report

Project Name: DSH-METROPOLITAN SNF BLDG

Project ID: 196636

417-120	SNF	417	1	SG	3' 0"	6' 8"	1 3/4"	60	56.04M.69.7.K P.WP			https://www.openingsstudio.com/AAOS/AAOM/WebView?OP=ID&ID=30488ec9-02de-49d2-ad21-7fb09ada0f1a
417-121	SNF	417	1	SG	3' 6"	6' 8"	1 3/4"	20	56.38M.69.7			https://www.openingsstudio.com/AAOS/AAOM/WebView?OP=ID&ID=9ca626db-b91c-47bd-91cc-14d1edaf7c4c
417-121A	SNF	417	1	SG	3' 6"	7' 0"	1 3/4"		26.38M.A.69.5. TH.KP.DC.DB(1)			https://www.openingsstudio.com/AAOS/AAOM/WebView?OP=ID&ID=491e1fe9-3439-4037-972b-33468d769640
417-122	SNF	417	1	SG	2' 6"	6' 8"	1 3/4"	20	56.04M.69.4(4")			https://www.openingsstudio.com/AAOS/AAOM/WebView?OP=ID&ID=c5f6bf6f-f7fd-45e8-bb63-673ced6a07ee
417-123	SNF	417	1	SG	3' 0"	6' 8"	1 3/4"	None	26.38M.69.7.S W.			https://www.openingsstudio.com/AAOS/AAOM/WebView?OP=ID&ID=84c59a24-e17c-4f59-af06-a82e778e0a7e
417-124	SNF	417	1	SG	3' 8"	6' 8"	1 3/4"	20	55.95HL/03.69. 5.KP.WP			https://www.openingsstudio.com/AAOS/AAOM/WebView?OP=ID&ID=e26123eb-ed06-4157-99f1-914e342c55e0
417-125	SNF	417	1	SG	3' 0"	6' 8"	1 3/4"	20	55.95HL/03.69. 5.KP.WP			https://www.openingsstudio.com/AAOS/AAOM/WebView?OP=ID&ID=2a20d015-99a7-4fbc-9012-789523bf2051
417-126	SNF	417	1	SG	3' 0"	6' 8"	1 3/4"	20	56.04M.69.7.K P.WP			https://www.openingsstudio.com/AAOS/AAOM/WebView?OP=ID&ID=f6350ac8-57d7-440b-964c-27504513ead3
417-127	SNF	417	1	SG	3' 8"	6' 8"	1 3/4"	20	55.95HL/03.69. 5.KP.WP			https://www.openingsstudio.com/AAOS/AAOM/WebView?OP=ID&ID=8911e23b-f328-480c-8cf6-0a5b58fb9644
419-128	SNF	419	1	SG	3' 8"	6' 8"	1 3/4"	20	55.95HL.69.5.K P.WP.MHO			https://www.openingsstudio.com/AAOS/AAOM/WebView?OP=ID&ID=0a96b1ff-89f1-4bec-aa3b-d28121da0cbb
419-129	SNF	419	1	SG	3' 8"	6' 8"	1 3/4"	20	55.95HL.69.5.K P.WP.MHO			https://www.openingsstudio.com/AAOS/AAOM/WebView?OP=ID&ID=e114b74b-072e-45de-a31a-37c506dc0256
419-130	SNF	419	1	SG	3' 8"	6' 8"	1 3/4"	20	55.95HL.69.5.K P.WP.MHO			https://www.openingsstudio.com/AAOS/AAOM/WebView?OP=ID&ID=2c2b70cd-6052-4e97-85f5-32f9925fe1b8
417-131A	SNF	417	1	SG	4' 0"	6' 8"	1 3/4"	20	56.38M.69.7.W P			https://www.openingsstudio.com/AAOS/AAOM/WebView?OP=ID&ID=7c38b569-beaa-4618-986a-0fe94d7cf4cb
417-132	SNF	417	1	SG	2' 6"	6' 8"	1 3/4"	20	56.04M.69.5.W P			https://www.openingsstudio.com/AAOS/AAOM/WebView?OP=ID&ID=10b0d39f-a4ef-4a1d-b3fb-9edc23c7c2a6
417-133	SNF	417	1	SG	3' 8"	6' 8"	1 3/4"	20	55.95HL/03.69. 5.KP.WP			https://www.openingsstudio.com/AAOS/AAOM/WebView?OP=ID&ID=8c38e06f-dd26-474a-b2eb-4cccc16e9271
417-134	SNF	417	1	SG	3' 0"	6' 8"	1 3/4"	20	56.38M/03C.69 .7.WP			https://www.openingsstudio.com/AAOS/AAOM/WebView?OP=ID&ID=2ac83db1-1491-4508-8d09-48baab7ddbab
417-135	SNF	417	1	SG	3' 8"	6' 8"	1 3/4"	20	55.95HL/03.69. 5.KP.WP			https://www.openingsstudio.com/AAOS/AAOM/WebView?OP=ID&ID=13e2c077-5299-4698-a391-0b5ef87cbc8e
417-136	SNF	417	1	SG	3' 8"	6' 8"	1 3/4"	20	55.95HL/03.69. 5.KP.WP.MHO			https://www.openingsstudio.com/AAOS/AAOM/WebView?OP=ID&ID=b7935cc5-8122-4a2f-a179-507e156fd88f
417-137	SNF	417	1	SG	3' 0"	6' 8"	1 3/4"	20	56.04M.69.7.W P			https://www.openingsstudio.com/AAOS/AAOM/WebView?OP=ID&ID=a324b3ee-49de-41db-be55-1412283f8d1a
417-139	SNF	417	1	SG	3' 8"	6' 8"	1 3/4"	20	55.95HL/03.69. 5.KP.WP			https://www.openingsstudio.com/AAOS/AAOM/WebView?OP=ID&ID=75d665bd-4918-4fa5-a3d8-18fb6638e26d
417-140	SNF	417	1	SG	3' 0"	6' 8"	1 3/4"	20	56.38M.69.7.W P			https://www.openingsstudio.com/AAOS/AAOM/WebView?OP=ID&ID=f01ded37-3066-4210-b5f6-49be34ea4d90
417-141	SNF	417	1	SG	3' 0"	6' 8"	1 3/4"	20	56.04M.69.7.W P			https://www.openingsstudio.com/AAOS/AAOM/WebView?OP=ID&ID=dabd5d47-e93f-435c-8ea2-d16897ab9145
417-142	SNF	417	1	SG	3' 0"	6' 8"	1 3/4"	20	56.04M/04C.69 .7.MHO			https://www.openingsstudio.com/AAOS/AAOM/WebView?OP=ID&ID=a37d6aaf-ebf2-457d-af05-1ac30c690599
417-143	SNF	417	1	SG	3' 0"	6' 8"	1 3/4"	20	56.38M/03C.69 .7.KP.WP			https://www.openingsstudio.com/AAOS/AAOM/WebView?OP=ID&ID=593247c2-ed8c-4bde-adaf-5743ab18ca54
417-144	SNF	417	1	SG	3' 0"	6' 8"	1 3/4"		56.38M/03C.69 .7.WP			https://www.openingsstudio.com/AAOS/AAOM/WebView?OP=ID&ID=f8c23532-21d7-401d-9092-c31ff2921209
417-145	SNF	417	1	SG	3' 0"	6' 8"	1 3/4"	20	56.04M.69.7.K P.WP			https://www.openingsstudio.com/AAOS/AAOM/WebView?OP=ID&ID=68fe971a-a639-4c08-a049-8053b4b105d0

080610 - Door Schedule Report

Project Name: DSH-METROPOLITAN SNF BLDG

Project ID: 196636

417-146	SNF	417	1	SG	3' 0"	6' 8"	1 3/4"	20	56.04M.69.7.K P.WP			https://www.openingsstudio.com/AAOS/AAOM/WebView?OP=ID&ID=152c493c-81f3-4862-8c1b-a8341fdd0315
417-147	SNF	417	1	SG	2' 6"	6' 8"	1 3/4"	60	56.04M.69.4(4") .KP			https://www.openingsstudio.com/AAOS/AAOM/WebView?OP=ID&ID=8c19f4dd-7052-4567-8365-45d90da1e553
417-148	SNF	417	1	AI	4' 0"	6' 8"	1 3/4"	20	56.04M.41.4(4") .AF.KP.AS			https://www.openingsstudio.com/AAOS/AAOM/WebView?OP=ID&ID=e256926c-ccc7-427a-9e09-32f0d7a8bbc7
417-149	SNF	417	1	SG	3' 0"	6' 8"	1 3/4"		55.95HL/03.50. 7.KP.WP			https://www.openingsstudio.com/AAOS/AAOM/WebView?OP=ID&ID=a4d0ce49-1e79-43ca-8b6d-8c483f7ed2a4
417-150	SNF	417	1	SG	3' 8"	6' 8"	1 3/4"	20	56.05M.69.5.K P.WP.MHO			https://www.openingsstudio.com/AAOS/AAOM/WebView?OP=ID&ID=9d7a9c1e-4f0e-4ca4-aff0-5c183585e529
417-151	SNF	417	1	SG	3' 8"	6' 8"	1 3/4"	20	56.05M.69.5.K P.WP.MHO			https://www.openingsstudio.com/AAOS/AAOM/WebView?OP=ID&ID=98b5e21c-e29f-49a0-89c4-fe55e48a4620
417-152	SNF	417	1	SG	3' 8"	6' 8"	1 3/4"	20	55.95HL/03.69. 5.KP.WP.MHO(1)			https://www.openingsstudio.com/AAOS/AAOM/WebView?OP=ID&ID=8c97c7c1-1756-4009-82f9-2b943298ffe0
417-153	SNF	417	1	SG	3' 0"	6' 8"	1 3/4"	20	55.95HL/03.69. 5.KP.WP.MHO			https://www.openingsstudio.com/AAOS/AAOM/WebView?OP=ID&ID=4829df2b-d7d8-4d3c-9690-2c61aa92b7a3
417-154	SNF	417	1	SG	3' 8"	6' 8"	1 3/4"	20	55.95HL/03.69. 5.KP.WP.MHO			https://www.openingsstudio.com/AAOS/AAOM/WebView?OP=ID&ID=8bebb7d4-f9e3-443b-af50-04ad30299b52
417-155	SNF	417	1	SG	3' 8"	6' 8"	1 3/4"	20	55.95HL/03.69. 5.KP.WP.MHO			https://www.openingsstudio.com/AAOS/AAOM/WebView?OP=ID&ID=142c7c81-8dc2-4fd0-9610-83d18ee72372
417-156	SNF	417	1	SG	3' 0"	6' 8"	1 3/4"	20	56.04M.69.7.K P.WP			https://www.openingsstudio.com/AAOS/AAOM/WebView?OP=ID&ID=9ab4a08d-b92d-42d3-80b4-4c0cdaa9a09f
417-157	SNF	417	1	SG	3' 0"	6' 8"	1 3/4"	20	56.04M.69.7.K P.WP			https://www.openingsstudio.com/AAOS/AAOM/WebView?OP=ID&ID=49c5c63c-466e-45f8-ab0b-09ba3582efa1
417-C100	SNF	417	1	DE	7' 0"	6' 8"	1 3/4"	20	45.10.69.5.T.S V.KP.EG.MHO			https://www.openingsstudio.com/AAOS/AAOM/WebView?OP=ID&ID=9bab1ba1-1854-43a4-b12e-8947079ff9f6
418-101A	SNF	418	1	SG	3' 0"	6' 8"	1 3/4"	20	56.38M.69.7			https://www.openingsstudio.com/AAOS/AAOM/WebView?OP=ID&ID=10212488-ee9-48b6-a078-0878da8e1499
418-101B	SNF	418	1	SG	3' 6"	7' 0"	1 3/4"		26.38M/99.69.6 .TH.MF.KP.DB. AS(1)			https://www.openingsstudio.com/AAOS/AAOM/WebView?OP=ID&ID=4a192bf3-0634-403d-bc4c-aa15b319801f
418-101C	SNF	418	1	AI	6' 0"	7' 0"	1 3/4"		26.38M/99.69.6 .TH.MF.KP.DB. AS			https://www.openingsstudio.com/AAOS/AAOM/WebView?OP=ID&ID=deb34f0c-83ce-42b2-aa3e-1baae0467ecd
418-101D	SNF	418	1	AI	6' 0"	7' 0"	1 3/4"	None	26.38M/99.11P B.6.TH.MF.KP.			https://www.openingsstudio.com/AAOS/AAOM/WebView?OP=ID&ID=89b582c9-102a-4e36-a4ce-fde6e8e420c6
418-101E	SNF	418	1	SG	3' 0"	6' 8"	1 3/4"	20	56.38M.69.7.K P.(1)			https://www.openingsstudio.com/AAOS/AAOM/WebView?OP=ID&ID=cc19be2b-c411-477a-b381-18e18df80b65
418-102	SNF	418	1	SG	2' 6"	6' 8"	1 3/4"	60	56.04M.50.4(4x 4).			https://www.openingsstudio.com/AAOS/AAOM/WebView?OP=ID&ID=50b95c5e-6910-4a6e-97ed-51dadcd0bc5e
418-103	SNF	418	1	SG	2' 7"	8' 0"	1"		99.0		Custom door and frame	https://www.openingsstudio.com/AAOS/AAOM/WebView?OP=ID&ID=8d6f1b99-c968-4dd7-9bb6-27ae096bc3ba
418-104A	SNF	418	1	SG	3' 0"	6' 8"	1 3/4"	20	56.04M.69.7.A P			https://www.openingsstudio.com/AAOS/AAOM/WebView?OP=ID&ID=bd257093-1fb9-4625-834d-e49bc5b04636
418-104B	SNF	418	1	SG	3' 0"	6' 8"	1 3/4"	20	56.04M.69.7			https://www.openingsstudio.com/AAOS/AAOM/WebView?OP=ID&ID=b510bd43-b327-444f-a7f5-6e50a3b0e123
418-107	SNF	418	1	SG	3' 8"	7' 0"	1 3/4"		26.04M.A.69.5. TH.KP.DC.DB(2)			https://www.openingsstudio.com/AAOS/AAOM/WebView?OP=ID&ID=8d9c9bd6-fe3c-4090-b4aa-37e20ac73b69
418-108	SNF	418	1	SG	3' 0"	6' 8"	1 3/4"	90	26.04M.69.7.S W.			https://www.openingsstudio.com/AAOS/AAOM/WebView?OP=ID&ID=70faf6ad-b71a-4ac8-a2c1-5c5b71bb9adc

080610 - Door Schedule Report

Project Name: DSH-METROPOLITAN SNF BLDG

Project ID: 196636

418-109	SNF	418	1	AI	4' 8"	6' 8"	1 3/4"	20	56.04M.69.7.M F.AS		https://www.openingsstudio.com/AAOS/AAOM/WebViewer?OP=ID&ID=a7308e85-ce61-4c35-a3f9-e19b60e88737
418-110	SNF	418	1	SG	2' 6"	6' 8"	1 3/4"	20	56.04M.69.4(4")		https://www.openingsstudio.com/AAOS/AAOM/WebViewer?OP=ID&ID=5b0f06a4-45ae-42de-8cf3-a74de9bbc566
418-111	SNF	418	1	SG	3' 0"	6' 8"	1 3/4"	20	56.04M.69.5.		https://www.openingsstudio.com/AAOS/AAOM/WebViewer?OP=ID&ID=060c64e2-b6eb-4fe0-b274-fedb49a7d7b7
418-112	SNF	418	1	SG	3' 8"	6' 8"	1 3/4"	20	55.95HL/03.69. 5.KP.WP		https://www.openingsstudio.com/AAOS/AAOM/WebViewer?OP=ID&ID=cf177d87-3fa7-46c2-b2ee-c9cc11f1a42e
418-113	SNF	418	1	SG	3' 0"	6' 8"	1 3/4"	20	56.04M.69.7		https://www.openingsstudio.com/AAOS/AAOM/WebViewer?OP=ID&ID=69e96ebb-b136-4c64-9616-57315875b5ac
418-114	SNF	418	1	SG	3' 0"	6' 8"	1 3/4"	20	56.04M.69.7		https://www.openingsstudio.com/AAOS/AAOM/WebViewer?OP=ID&ID=477d2a4a-af76-4da0-b3c3-ee40ef0d29fa
418-115	SNF	418	1	SG	3' 8"	6' 8"	1 3/4"	20	55.95HL.69.5.K P.WP(5)		https://www.openingsstudio.com/AAOS/AAOM/WebViewer?OP=ID&ID=767f0473-ca67-4ccb-8e7f-9385e068fd65
418-116	SNF	418	1	SG	3' 8"	6' 8"	1 3/4"	20	56.04M.69.5.W P.MHO		https://www.openingsstudio.com/AAOS/AAOM/WebViewer?OP=ID&ID=04a5727e-3ed5-4ca4-964c-9afec5f051ae
418-117	SNF	418	1	SG	3' 8"	6' 8"	1 3/4"	20	55.95HL.69.5.K P.WP.MHO		https://www.openingsstudio.com/AAOS/AAOM/WebViewer?OP=ID&ID=025343c3-28cc-45b0-aaf0-486a31d85e2a
418-118	SNF	418	1	SG	3' 8"	6' 8"	1 3/4"	20	55.95HL.69.5.K P.WP.MHO		https://www.openingsstudio.com/AAOS/AAOM/WebViewer?OP=ID&ID=3785dc43-f503-4e96-b88e-504e7bd9ed09
418-120A	SNF	418	1	SG	3' 6"	7' 0"	1 3/4"	None	26.04M.A.69.5. TH.KP.DC.DB(1)		https://www.openingsstudio.com/AAOS/AAOM/WebViewer?OP=ID&ID=1538a633-b369-4fc9-9159-4954fc5744db
418-121	SNF	418	1	SG	3' 0"	6' 8"	1 3/4"	20	56.04M.69.7.W P		https://www.openingsstudio.com/AAOS/AAOM/WebViewer?OP=ID&ID=ea422c9f-4600-4199-8542-830673c8cbc1
418-122	SNF	418	1	SG	2' 6"	6' 8"	1 3/4"	20	56.04M.69.4(4")		https://www.openingsstudio.com/AAOS/AAOM/WebViewer?OP=ID&ID=78cdf3a4-bd54-4d59-b70f-ceb635374e75
418-123	SNF	420	1	SG	3' 0"	6' 8"	1 3/4"	90	26.38M.69.4(4") .SW.		https://www.openingsstudio.com/AAOS/AAOM/WebViewer?OP=ID&ID=65b2e68d-1a43-4f2b-8d75-20f95aea4e6b
418-124	SNF	418	1	SG	3' 8"	6' 8"	1 3/4"	20	55.95HL/03.69. 5.KP.WP		https://www.openingsstudio.com/AAOS/AAOM/WebViewer?OP=ID&ID=e4b8b72b-6dd7-4f86-a38d-fe5cc99635cd
418-125	SNF	418	1	SG	3' 0"	6' 8"	1 3/4"	20	55.95HL.69.5.K P.WP(2)		https://www.openingsstudio.com/AAOS/AAOM/WebViewer?OP=ID&ID=27fe6d8d-175b-42bf-9795-f05f7fa29067
418-126	SNF	418	1	SG	3' 0"	6' 8"	1 3/4"	20	56.04M.69.5.		https://www.openingsstudio.com/AAOS/AAOM/WebViewer?OP=ID&ID=f8bffd9-4bfe-4c31-95fd-7c9dd70f8d57
418-127	SNF	418	1	SG	3' 8"	6' 8"	1 3/4"	20	55.95HL.69.5.K P.WP(1)		https://www.openingsstudio.com/AAOS/AAOM/WebViewer?OP=ID&ID=227215b3-a973-45d9-b5f5-4e98694e8d80
418-128	SNF	418	1	SG	3' 8"	6' 8"	1 3/4"	20	55.95HL.69.5.K P.WP(3)		https://www.openingsstudio.com/AAOS/AAOM/WebViewer?OP=ID&ID=317764ac-c3ef-4b50-bfa9-ca8eaa81320f
418-129	SNF	418	1	SG	3' 8"	6' 8"	1 3/4"	20	55.95HL.69.5.K P.WP(6)		https://www.openingsstudio.com/AAOS/AAOM/WebViewer?OP=ID&ID=e82e204e-aff9-47a7-b0b5-2bdad43b76ce
418-130	SNF	418	1	SG	3' 8"	6' 8"	1 3/4"	20	55.95HL.69.5.K P.WP(4)		https://www.openingsstudio.com/AAOS/AAOM/WebViewer?OP=ID&ID=5a712f68-551c-48e2-be8b-c38b82a7bf77
418-132	SNF	418	1	SG	2' 6"	6' 8"	1 3/4"	20	56.04M.69.7		https://www.openingsstudio.com/AAOS/AAOM/WebViewer?OP=ID&ID=f87981fe-07c3-4209-8f08-97438d1bdb3e
418-133	SNF	418	1	SG	3' 8"	6' 8"	1 3/4"	20	55.95HL/03.69. 5.KP.WP		https://www.openingsstudio.com/AAOS/AAOM/WebViewer?OP=ID&ID=7208383b-a4b1-4a86-8260-9ebf3162c2be
418-134	SNF	418	1	SG	3' 0"	6' 8"	1 3/4"	20	56.38M/03C.69 .7		https://www.openingsstudio.com/AAOS/AAOM/WebViewer?OP=ID&ID=a3d5c612-943b-48ac-815a-b4524e38aff0
418-135	SNF	418	1	SG	3' 8"	6' 8"	1 3/4"	20	55.95HL/03.69. 5.KP.WP.MHO		https://www.openingsstudio.com/AAOS/AAOM/WebViewer?OP=ID&ID=878e5b7f-11f6-4943-92e7-abab7a4e536e
418-136	SNF	418	1	SG	3' 8"	6' 8"	1 3/4"	20	55.95HL.69.5.K P.WP.MHO		https://www.openingsstudio.com/AAOS/AAOM/WebViewer?OP=ID&ID=7c1edf7b-9a75-4b1c-a834-612690ead902

080610 - Door Schedule Report

Project Name: DSH-METROPOLITAN SNF BLDG

Project ID: 196636

418-137	SNF	418	1	SG	3' 0"	6' 8"	1 3/4"	20	56.04M.69.7.		https://www.openingsstudio.com/AAOS/AAOM/WebView?OP=ID&ID=cab4017b-5a6f-4b1a-9ee6-7e39f31e23d3
418-139	SNF	418	1	SG	3' 8"	6' 8"	1 3/4"	20	55.95HL.69.5.WP		https://www.openingsstudio.com/AAOS/AAOM/WebView?OP=ID&ID=50ea1454-0af4-46e5-b578-a4225e7824c4
418-140	SNF	418	1	SG	3' 0"	6' 8"	1 3/4"	20	56.04M.69.7.KP		https://www.openingsstudio.com/AAOS/AAOM/WebView?OP=ID&ID=a08b9ddc-a593-40dc-bd4c-129350d28ce7
418-141	SNF	418	1	SG	3' 0"	6' 8"	1 3/4"	20	56.04M.69.7.KP		https://www.openingsstudio.com/AAOS/AAOM/WebView?OP=ID&ID=f723c40c-d59e-47f6-b8fd-cfbc92c2d3b7
418-142	SNF	418	1	SG	3' 0"	6' 8"	1 3/4"	20	56.04M/04C.69.7.MHO		https://www.openingsstudio.com/AAOS/AAOM/WebView?OP=ID&ID=656b315f-d5e5-4804-8cc3-6e2dc4e55242
418-143	SNF	418	1	SG	3' 0"	6' 8"	1 3/4"	20	56.38M/03C.69.7.KP		https://www.openingsstudio.com/AAOS/AAOM/WebView?OP=ID&ID=f2ddf626-cc0d-45f0-9bfc-1c24d42cec35
418-144	SNF	418	1	SG	3' 0"	6' 8"	1 3/4"	20	56.38M.50.7.WP		https://www.openingsstudio.com/AAOS/AAOM/WebView?OP=ID&ID=eedcc6cc-3759-42cc-81a4-6f78048a7b27
418-145	SNF	418	1	SG	3' 0"	6' 8"	1 3/4"	20	56.04M.69.7.KP		https://www.openingsstudio.com/AAOS/AAOM/WebView?OP=ID&ID=4689924f-6b4e-4693-9f6a-f196c03fac57
418-146	SNF	418	1	SG	3' 0"	6' 8"	1 3/4"	60	56.04M.69.4(4")		https://www.openingsstudio.com/AAOS/AAOM/WebView?OP=ID&ID=5a2c62e6-0946-43d0-9047-e8f0eeccaadb
418-147	SNF	418	1	SG	2' 6"	6' 8"	1 3/4"	20	56.04M.69.4(4") (1)		https://www.openingsstudio.com/AAOS/AAOM/WebView?OP=ID&ID=ce00e0ce-52f4-41ab-87a6-86de91d34ce1
418-148	SNF	418	1	AI	4' 8"	6' 8"	1 3/4"	20	56.04M.69.4(4") ,MF.AS		https://www.openingsstudio.com/AAOS/AAOM/WebView?OP=ID&ID=a7f9314f-563c-41ee-9593-807051c954b3
418-149	SNF	418	1	SG	3' 0"	6' 8"	1 3/4"	20	55.95HL/03.50.7.WP		https://www.openingsstudio.com/AAOS/AAOM/WebView?OP=ID&ID=696a23e4-04df-43ad-b04e-4931944bd744
418-150	SNF	418	1	SG	3' 8"	6' 8"	1 3/4"	20	56.37M.69.5.		https://www.openingsstudio.com/AAOS/AAOM/WebView?OP=ID&ID=e8cdf17a-e76e-4904-b4e4-f5892058100f
418-151	SNF	418	1	SG	3' 8"	6' 8"	1 3/4"	20	56.04M.69.5.		https://www.openingsstudio.com/AAOS/AAOM/WebView?OP=ID&ID=31dbc1db-6603-42d9-9c8b-1c96d3194f13
418-152	SNF	418	1	SG	3' 8"	6' 8"	1 3/4"	20	55.95HL.69.5.WP.MHO		https://www.openingsstudio.com/AAOS/AAOM/WebView?OP=ID&ID=27c08d1d-e812-4f54-b323-6a3d62767fbb
418-153	SNF	418	1	SG	3' 8"	6' 8"	1 3/4"	20	55.95HL.69.5.KP.WP.MHO		https://www.openingsstudio.com/AAOS/AAOM/WebView?OP=ID&ID=d5206be4-9114-4a48-88a1-ded32e4cdd56
418-154	SNF	418	1	SG	3' 8"	6' 8"	1 3/4"	20	55.95HL.69.5.KP.WP.MHO		https://www.openingsstudio.com/AAOS/AAOM/WebView?OP=ID&ID=54483fd3-b50f-4ca3-8a48-87a39c156fa8
418-155	SNF	418	1	SG	3' 8"	6' 8"	1 3/4"	20	55.95HL.69.5.KP.WP.MHO		https://www.openingsstudio.com/AAOS/AAOM/WebView?OP=ID&ID=e1a7b7f2-c981-452d-942c-25bc57befd90
418-156	SNF	418	1	SG	3' 0"	6' 8"	1 3/4"	20	56.04M.69.7.KP		https://www.openingsstudio.com/AAOS/AAOM/WebView?OP=ID&ID=6eee43cf-45b0-447c-9819-72431792249f
418-157	SNF	418	1	SG	3' 0"	6' 8"	1 3/4"	20	56.04M.69.7.KP		https://www.openingsstudio.com/AAOS/AAOM/WebView?OP=ID&ID=10db7934-1892-4db5-8da1-1cbc7ad2f004
418-162	SNF	418	1	SG	3' 0"	6' 8"	1 3/4"	20	56.04M.69.7.		https://www.openingsstudio.com/AAOS/AAOM/WebView?OP=ID&ID=9a026904-4fcb-494c-9456-9560a07a3b23
418-C100	SNF	418	1	DE	6' 0"	6' 8"	1 3/4"	20	45.10.69.5.T.S.V.KP.EG.MHO		https://www.openingsstudio.com/AAOS/AAOM/WebView?OP=ID&ID=c7516147-9f20-4c73-81a4-374506bb0542
419-101A	SNF	419	1	SG	3' 0"	6' 8"	1 3/4"	20	56.04M.69.7.KP.WP		https://www.openingsstudio.com/AAOS/AAOM/WebView?OP=ID&ID=5025e0ab-06a6-465e-af00-68ab90e6ac27
419-101B	SNF	419	1	SG	3' 0"	6' 8"	1 3/4"	20	56.38M.69.7.KP.AP		https://www.openingsstudio.com/AAOS/AAOM/WebView?OP=ID&ID=0b71d1dd-5dd5-4556-8f92-4379ded16628
419-101C	SNF	419	1	SG	3' 8"	7' 0"	1 3/4"		26.38M/99.69.5.TH.KP		https://www.openingsstudio.com/AAOS/AAOM/WebView?OP=ID&ID=41644370-368b-4dfe-adb6-3dae19f23967
419-101D	SNF	419	1	AI	6' 0"	7' 0"	1 3/4"		26.38M/99.00.5.TH.MF.KP.		https://www.openingsstudio.com/AAOS/AAOM/WebView?OP=ID&ID=30695a27-89fe-45d0-b714-5a246f90a2d7

080610 - Door Schedule Report

Project Name: DSH-METROPOLITAN SNF BLDG

Project ID: 196636

419-101E	SNF	419	1	AI	6' 0"	6' 8"	1 3/4"		26.38M.99.11P B.5.TH.MF.KP.			https://www.openingsstudio.com/AAOS/AAOM/WebView?OP=ID&ID=883a999d-9a14-455d-bee0-ee60e9d4c543
419-102	SNF	419	1	SG	2' 6"	6' 8"	1 3/4"	20	56.38M.50.4(4x 4).			https://www.openingsstudio.com/AAOS/AAOM/WebView?OP=ID&ID=33c48170-0627-41af-b1ec-ee5c8fd6000b
419-103	SNF	419	1	SG	2' 7"	8' 0"	1"		99.0		Custom door and frame	https://www.openingsstudio.com/AAOS/AAOM/WebView?OP=ID&ID=7b9b50b8-b5ec-4a87-9576-89eb86c14af0
419-104A	SNF	419	1	SG	3' 0"	6' 8"	1 3/4"	20	56.38M.69.7.K P.			https://www.openingsstudio.com/AAOS/AAOM/WebView?OP=ID&ID=17d0eb3f-a689-42c3-8720-133be71ff98a
419-104B	SNF	419	1	SG	3' 0"	6' 8"	1 3/4"	None	56.04M.69.7.K P.WP			https://www.openingsstudio.com/AAOS/AAOM/WebView?OP=ID&ID=3d9dca6e-f0a7-4164-ad29-c64ac83af240
419-107A	SNF	419	1	SG	3' 0"	7' 0"	1 3/4"		26.04M.A.69.5. TH.KP.DC.DB			https://www.openingsstudio.com/AAOS/AAOM/WebView?OP=ID&ID=7d0bcec1-cd9d-4e1b-82f8-ff93d87bc165
419-108	SNF	419	1	SG	3' 0"	6' 8"	1 3/4"	90	26.04M.69.7.S W.			https://www.openingsstudio.com/AAOS/AAOM/WebView?OP=ID&ID=37d53abc-4a95-46f7-a9a3-195195e0869b
419-109	SNF	419	1	AI	4' 8"	6' 8"	1 3/4"	20	56.04M.69.7.M F			https://www.openingsstudio.com/AAOS/AAOM/WebView?OP=ID&ID=8c7f259c-5566-45ea-b85c-e7d06f16dd48
419-110	SNF	419	1	SG	2' 6"	6' 8"	1 3/4"	20	56.04M.69.7			https://www.openingsstudio.com/AAOS/AAOM/WebView?OP=ID&ID=34657e1e-0956-414f-b8b3-9162d518e66e
419-111	SNF	419	1	SG	3' 0"	6' 8"	1 3/4"	20	56.04M.69.5.K P.WP			https://www.openingsstudio.com/AAOS/AAOM/WebView?OP=ID&ID=5da0f637-e406-4572-9346-bd6a36c09438
419-112	SNF	419	1	SG	3' 8"	6' 8"	1 3/4"	20	55.95HL/03.69. 5.KP.WP			https://www.openingsstudio.com/AAOS/AAOM/WebView?OP=ID&ID=0afda182-17bd-41ca-b717-d604106ff1a0
419-113	SNF	419	1	SG	3' 0"	6' 8"	1 3/4"	20	55.95HL.69.5.T .WP			https://www.openingsstudio.com/AAOS/AAOM/WebView?OP=ID&ID=bf90835c-d9b7-40b2-adca-503aeea4d193
419-114	SNF	419	1	SG	3' 0"	6' 8"	1 3/4"	20	56.04M.69.5.K P.WP			https://www.openingsstudio.com/AAOS/AAOM/WebView?OP=ID&ID=c16d8251-65c2-4c8f-981c-75fbc26d0470
419-115	SNF	419	1	SG	3' 8"	6' 8"	1 3/4"	20	55.95HL.69.5.K P.WP			https://www.openingsstudio.com/AAOS/AAOM/WebView?OP=ID&ID=027fbc06-b136-47d3-8a98-93c109ccaa60
419-116	SNF	419	1	SG	3' 8"	6' 8"	1 3/4"	20	55.95HL.69.5.K P.WP.MHO			https://www.openingsstudio.com/AAOS/AAOM/WebView?OP=ID&ID=b9e2a6ae-4377-4de8-a01e-f9db5deeb5a7
419-117	SNF	419	1	SG	3' 8"	6' 8"	1 3/4"	20	55.95HL.69.5. WP.MHO			https://www.openingsstudio.com/AAOS/AAOM/WebView?OP=ID&ID=21598fb7-44c7-45d4-aecb-e6854b096c47
419-118	SNF	419	1	SG	3' 8"	6' 8"	1 3/4"	20	55.95HL.69.5.K P.WP.MHO			https://www.openingsstudio.com/AAOS/AAOM/WebView?OP=ID&ID=198df5dd-f9e0-4d16-b473-ad3eff685b81
419-120A	SNF	419	1	SG	3' 8"	7' 0"	1 3/4"		26.38M.A.69.5. TH.KP.DC.DB			https://www.openingsstudio.com/AAOS/AAOM/WebView?OP=ID&ID=973edd00-d1f5-41a8-828c-d24e0638a1aa
419-121	SNF	419	1	SG	3' 0"	6' 8"	1 3/4"	90	56.04M.69.7.W P			https://www.openingsstudio.com/AAOS/AAOM/WebView?OP=ID&ID=2381dd13-e194-4a60-b040-31887f5cbbfe
419-122	SNF	419	1	SG	2' 6"	6' 8"	1 3/4"	20	56.04M.69.7			https://www.openingsstudio.com/AAOS/AAOM/WebView?OP=ID&ID=e9824c58-b39b-47a4-9892-c23f3fb3a293
419-123	SNF	419	1	SG	3' 0"	6' 8"	1 3/4"	90	26.38M.69.7.S W.			https://www.openingsstudio.com/AAOS/AAOM/WebView?OP=ID&ID=0a75c921-7f28-4b81-aac5-7f4211ade834
419-124	SNF	419	1	SG	3' 8"	6' 8"	1 3/4"	20	55.95HL/03.69. 5.KP.WP			https://www.openingsstudio.com/AAOS/AAOM/WebView?OP=ID&ID=3fd60489-910a-4591-a03a-eaf8f1387fb0
419-125	SNF	419	1	SG	3' 0"	6' 8"	1 3/4"	20	55.95HL.69.5.K P.WP			https://www.openingsstudio.com/AAOS/AAOM/WebView?OP=ID&ID=fe3194a6-edea-4fe4-939a-07451ac4d1ed
419-126	SNF	419	1	SG	3' 0"	6' 8"	1 3/4"	20	56.04M.69.5.			https://www.openingsstudio.com/AAOS/AAOM/WebView?OP=ID&ID=33acd050-17c2-4931-8a3a-def16580a1d0
419-127	SNF	419	1	SG	3' 8"	6' 8"	1 3/4"	20	55.95HL.69.5.K P.WP			https://www.openingsstudio.com/AAOS/AAOM/WebView?OP=ID&ID=ca92bbf7-c3a0-41cc-ad64-75839cc9bbaf
417-128	SNF	417	1	SG	3' 8"	6' 8"	1 3/4"	20	55.95HL/03.69. 5.KP.WP			https://www.openingsstudio.com/AAOS/AAOM/WebView?OP=ID&ID=f5795c33-0973-489a-b398-b2455c041203

080610 - Door Schedule Report

Project Name: DSH-METROPOLITAN SNF BLDG

Project ID: 196636

417-129	SNF	417	1	SG	3' 8"	6' 8"	1 3/4"	20	56.05M.69.5.K P.WP			https://www.openingsstudio.com/AAOS/AAOM/WebViewer?OP=ID&ID=2201ab0c-af27-417b-ae5e-d106af5c192d
417-130	SNF	417	1	SG	3' 8"	6' 8"	1 3/4"	20	55.95HL/03.69. 5.KP.WP			https://www.openingsstudio.com/AAOS/AAOM/WebViewer?OP=ID&ID=bb61bd57-0a0e-4188-b7bd-4d526588437d
419-132	SNF	419	1	SG	2' 6"	6' 8"	1 3/4"	20	56.04M.69.7			https://www.openingsstudio.com/AAOS/AAOM/WebViewer?OP=ID&ID=bb01525d-e36e-4b09-982c-f32292aec219
419-133	SNF	419	1	SG	3' 8"	6' 8"	1 3/4"	20	55.95HL/03.69. 5.KP.WP			https://www.openingsstudio.com/AAOS/AAOM/WebViewer?OP=ID&ID=e5ce7107-9773-412c-a645-3e43f6ec6de0
419-134	SNF	419	1	SG	3' 0"	6' 8"	1 3/4"	20	56.38M/03C.69 .7			https://www.openingsstudio.com/AAOS/AAOM/WebViewer?OP=ID&ID=82564064-a16e-4356-aab4-e7f20b1dbb3a
419-135	SNF	419	1	SG	3' 8"	6' 8"	1 3/4"	20	55.95HL/03.69. 5.KP.WP			https://www.openingsstudio.com/AAOS/AAOM/WebViewer?OP=ID&ID=c3802c4e-1942-40a1-bd67-20739c73d512
419-136	SNF	419	1	SG	3' 8"	6' 8"	1 3/4"	20	55.95HL.69.5.K P.WP			https://www.openingsstudio.com/AAOS/AAOM/WebViewer?OP=ID&ID=c26db20b-47df-48eb-b27f-903cdb8fe545
419-137	SNF	419	1	SG	3' 0"	6' 8"	1 3/4"	20	56.04M.69.7			https://www.openingsstudio.com/AAOS/AAOM/WebViewer?OP=ID&ID=f2a245d1-6dd3-41c1-a96a-37383f9db4bd
419-139	SNF	419	1	SG	3' 8"	6' 8"	1 3/4"	20	55.95HL.69.5.K P.WP			https://www.openingsstudio.com/AAOS/AAOM/WebViewer?OP=ID&ID=a29ac0bf-3e71-4033-b407-158fe00ceeda
419-140	SNF	419	1	SG	3' 0"	7' 0"	1 3/4"	20	56.04M.69.7.K P			https://www.openingsstudio.com/AAOS/AAOM/WebViewer?OP=ID&ID=732dc49a-5b64-45a0-abb5-8751b3a7c943
419-141	SNF	419	1	SG	3' 0"	6' 8"	1 3/4"	20	56.04M.69.7.K P.WP			https://www.openingsstudio.com/AAOS/AAOM/WebViewer?OP=ID&ID=4aa660bc-4baa-4f5e-b68f-eac773c5cfe1
419-142	SNF	419	1	SG	3' 0"	6' 8"	1 3/4"	20	56.04M/04C.69 .7			https://www.openingsstudio.com/AAOS/AAOM/WebViewer?OP=ID&ID=a3122313-4024-4892-a04b-31a92171c4a5
419-143	SNF	419	1	SG	3' 0"	6' 8"	1 3/4"	20	56.38M/03C.69 .7.KP			https://www.openingsstudio.com/AAOS/AAOM/WebViewer?OP=ID&ID=5077134a-7127-4c24-8626-fbf43b94a375
419-145	SNF	419	1	SG	3' 0"	6' 8"	1 3/4"	20	56.04M.69.7.K P			https://www.openingsstudio.com/AAOS/AAOM/WebViewer?OP=ID&ID=05c3d938-befd-4fb9-b9d7-fae99541d260
419-144	SNF	419	1	SG	3' 0"	6' 8"	1 3/4"	None	56.38M.50.7			https://www.openingsstudio.com/AAOS/AAOM/WebViewer?OP=ID&ID=e91eabb4-b6bf-426a-bd59-86b9587f4e29
419-146	SNF	419	1	SG	3' 0"	7' 0"	1 3/4"	20	56.04M.69.7			https://www.openingsstudio.com/AAOS/AAOM/WebViewer?OP=ID&ID=66fd90c4-2dee-447f-99cf-8eab3f7f9ae9
419-147	SNF	419	1	SG	2' 6"	6' 8"	1 3/4"	20	56.04M.69.4(4")			https://www.openingsstudio.com/AAOS/AAOM/WebViewer?OP=ID&ID=5705c468-b973-4e38-b765-3101563e6948
419-148	SNF	419	1	AI	4' 0"	6' 8"	1 3/4"	20	56.04M.41.7.A F.KP.AP			https://www.openingsstudio.com/AAOS/AAOM/WebViewer?OP=ID&ID=ae4ecb3-e9ba-4910-a04f-24fdee034df1
419-149	SNF	419	1	SG	3' 0"	6' 8"	1 3/4"		55.95HL/03.50. 7.WP			https://www.openingsstudio.com/AAOS/AAOM/WebViewer?OP=ID&ID=9e0c4c17-de27-48b5-a76d-968d021873c2
419-150	SNF	419	1	SG	3' 8"	6' 8"	1 3/4"	20	55.37M.69.5.M HO			https://www.openingsstudio.com/AAOS/AAOM/WebViewer?OP=ID&ID=687bc682-d263-4cc7-bdc3-3e74fe1ea994
419-151	SNF	419	1	SG	3' 8"	6' 8"	1 3/4"		55.37M.69.5.W P.MHO			https://www.openingsstudio.com/AAOS/AAOM/WebViewer?OP=ID&ID=54e9223e-e4bd-4e55-94f6-5bdaf719735e
419-152	SNF	419	1	SG	3' 8"	6' 8"	1 3/4"	20	55.95HL.69.5. WP.MHO			https://www.openingsstudio.com/AAOS/AAOM/WebViewer?OP=ID&ID=c7aa7fa0-3758-48b7-bc71-4b42e03ce083
419-153	SNF	419	1	SG	3' 8"	6' 8"	1 3/4"	20	55.95HL.69.5.K P.WP.MHO			https://www.openingsstudio.com/AAOS/AAOM/WebViewer?OP=ID&ID=4cdfff29-1345-4fe2-93e0-f3af3b29d44b
419-154	SNF	419	1	SG	3' 8"	6' 8"	1 3/4"		55.95HL.69.5.K P.WP.MHO			https://www.openingsstudio.com/AAOS/AAOM/WebViewer?OP=ID&ID=2a213401-2d98-4d30-b177-4086814dbe17
419-155	SNF	419	1	SG	3' 8"	6' 8"	1 3/4"	20	55.95HL.69.5.K P.WP.MHO			https://www.openingsstudio.com/AAOS/AAOM/WebViewer?OP=ID&ID=e787f98d-0cc9-46b3-9cd7-0e9bfbcf455a
419-156	SNF	419	1	SG	3' 0"	6' 8"	1 3/4"	20	56.04M.69.7.K P			https://www.openingsstudio.com/AAOS/AAOM/WebViewer?OP=ID&ID=acab4f0e-0059-4b71-bcfb-999097ecbe88

080610 - Door Schedule Report

Project Name: DSH-METROPOLITAN SNF BLDG

Project ID: 196636

419-157	SNF	419	1	SG	3' 0"	6' 8"	1 3/4"	20	56.04M.69.7.K P				https://www.openingsstudio.com/AAOS/AAOM/WebView?OP=ID&ID=4895beef-444a-4c71-b8f6-ebb2aa78ffb6
419-158	SNF	419	1	SG	3' 0"	6' 8"	1 3/4"	20	56.04M.69.7				https://www.openingsstudio.com/AAOS/AAOM/WebView?OP=ID&ID=b4c4ab8b-ebd6-4565-af3a-b02f76268656
419-162	SNF	419	1	SG	3' 0"	6' 8"	1 3/4"	20	56.04M.69.7				https://www.openingsstudio.com/AAOS/AAOM/WebView?OP=ID&ID=93d85248-6d42-4067-b76f-1d01869cb8e3
419-C100	SNF	419	1	AA	7' 4"	6' 8"	1 3/4"	20	45.10.69.5.T.S V.KP.EG.MHO				https://www.openingsstudio.com/AAOS/AAOM/WebView?OP=ID&ID=d21980a1-e102-43f5-9d6e-49b7346f00df
420-101A	SNF	420	1	SG	3' 0"	6' 8"	1 3/4"	20	56.38M.69.7				https://www.openingsstudio.com/AAOS/AAOM/WebView?OP=ID&ID=6f1c25ca-d80b-4eb1-806e-ffd9a74ad105
420-101B	SNF	420	1	SG	3' 0"	6' 8"	1 3/4"	20	56.38M.69.7.W P				https://www.openingsstudio.com/AAOS/AAOM/WebView?OP=ID&ID=0abd9453-eb76-4a07-a299-0a73d2331a0c
420-101C	SNF	420	1	AI	6' 0"	7' 0"	1 3/4"		26.38M/99.11P B.5.MF.KP.AS(1)				https://www.openingsstudio.com/AAOS/AAOM/WebView?OP=ID&ID=b1836ff3-fc18-4655-a836-b5c7e5092679
420-101D	SNF	420	1	AI	6' 0"	7' 0"	1 3/4"	None	26.38M/99.69.5 .TH.MF.KP.DB				https://www.openingsstudio.com/AAOS/AAOM/WebView?OP=ID&ID=549bfb0a-2ad5-4682-8fac-b8e9b158a310
420-101E	SNF	420	1	SG	3' 6"	7' 0"	1 3/4"		26.38M/99.69.5 .TH.KP(1)				https://www.openingsstudio.com/AAOS/AAOM/WebView?OP=ID&ID=34963871-d820-434f-a98c-a12c6871cc2a
420-102	SNF	420	1	SG	2' 6"	6' 8"	1 3/4"	20	56.38M.50.4(4x 4).				https://www.openingsstudio.com/AAOS/AAOM/WebView?OP=ID&ID=fd934a4a-ee0f-4824-ba7b-37dcfb5eed6d
420-103	SNF	420	1	SG	2' 7"	8' 0"	1"	None	99.0			Custom door and frame	https://www.openingsstudio.com/AAOS/AAOM/WebView?OP=ID&ID=27464b73-fba9-4a23-9582-e83aa07cf8d2
420-104A	SNF	420	1	SG	3' 0"	6' 8"	1 3/4"	20	56.04M.69.7.K P.WP				https://www.openingsstudio.com/AAOS/AAOM/WebView?OP=ID&ID=8cda367b-393b-4ecc-8bec-4825a8b8661b
420-104B	SNF	420	1	SG	3' 0"	6' 8"	1 3/4"		56.04M.69.1.W P				https://www.openingsstudio.com/AAOS/AAOM/WebView?OP=ID&ID=808cec2a-5fb1-48a5-b9cf-f819b85e6fe4
420-107	SNF	420	1	SG	3' 6"	7' 0"	1 3/4"		26.38M.A.69.5. TH.KP.DC.DB				https://www.openingsstudio.com/AAOS/AAOM/WebView?OP=ID&ID=200bc616-4796-410f-ac26-174ee4ac24a5
420-108	SNF	420	1	SG	3' 0"	6' 8"	1 3/4"	90	26.04M.69.7.S W.				https://www.openingsstudio.com/AAOS/AAOM/WebView?OP=ID&ID=ba372fac-f859-44f8-b50c-18212d07e6ce
420-109	SNF	420	1	AI	4' 8"	6' 8"	1 3/4"	60	56.04M.69.7.M F				https://www.openingsstudio.com/AAOS/AAOM/WebView?OP=ID&ID=a6b2974e-8403-4b43-8e27-149e587b0acf
420-110	SNF	420	1	SG	2' 6"	6' 8"	1 3/4"	20	56.04M.69.7.				https://www.openingsstudio.com/AAOS/AAOM/WebView?OP=ID&ID=16998096-7a28-456c-a159-3c65be4c0866
420-111	SNF	420	1	SG	3' 0"	6' 8"	1 3/4"	20	56.04M.69.5.W P				https://www.openingsstudio.com/AAOS/AAOM/WebView?OP=ID&ID=c3974c99-b33e-482d-90f6-7d250b5bf8a8
420-112	SNF	420	1	SG	3' 8"	6' 8"	1 3/4"	20	55.95HL/03.69. 5.KP.WP				https://www.openingsstudio.com/AAOS/AAOM/WebView?OP=ID&ID=9ee4ede9-3266-4300-a30f-4ab9aead5a6f
420-113	SNF	420	1	SG	3' 0"	6' 8"	1 3/4"	20	55.37M.69.7.W P				https://www.openingsstudio.com/AAOS/AAOM/WebView?OP=ID&ID=7486dee1-1f31-406c-a100-d5f538a1ef0d
420-114	SNF	420	1	SG	3' 0"	6' 8"	1 3/4"	20	56.04M.69.5.				https://www.openingsstudio.com/AAOS/AAOM/WebView?OP=ID&ID=de80c337-aff3-4ad3-b29b-608862d2fe74
420-115	SNF	420	1	SG	3' 8"	6' 8"	1 3/4"	20	56.04M.69.5.K P.WP				https://www.openingsstudio.com/AAOS/AAOM/WebView?OP=ID&ID=7fd9af75-9bd4-48d1-b819-fa88cee7d157
420-116	SNF	420	1	SG	3' 8"	6' 8"	1 3/4"	20	55.37M.69.5.K P.WP.MHO				https://www.openingsstudio.com/AAOS/AAOM/WebView?OP=ID&ID=22170a3e-b68f-4a7a-88c6-15a6ee46cff7
420-117	SNF	420	1	SG	3' 8"	6' 8"	1 3/4"	20	55.37M.69.5.K P.WP.MHO				https://www.openingsstudio.com/AAOS/AAOM/WebView?OP=ID&ID=b1775a3e-4c55-44d1-b6b6-1a6188bc901e
420-118	SNF	420	1	SG	3' 8"	6' 8"	1 3/4"	20	55.37M.69.5.K P.WP.MHO				https://www.openingsstudio.com/AAOS/AAOM/WebView?OP=ID&ID=f22b5cb2-8f73-4f89-b27f-759752ef1657

080610 - Door Schedule Report

Project Name: DSH-METROPOLITAN SNF BLDG

Project ID: 196636

420-120A	SNF	420	1	SG	3' 6"	7' 0"	1 3/4"	None	26.38M.A.69.5. TH.KP			https://www.openingsstudio.com/AAOS/AAOM/WebView?OP=ID&ID=5a59f466-e95d-4b85-b9ba-eb5114e9d53b
420-121	SNF	420	1	SG	3' 0"	6' 8"	1 3/4"	20	56.04M.69.4(4")5			https://www.openingsstudio.com/AAOS/AAOM/WebView?OP=ID&ID=faccf06c-a66c-4d1e-bc17-582c902e0744
420-122	SNF	420	1	SG	3' 0"	6' 8"	1 3/4"	20	56.04M.69.4(4")4			https://www.openingsstudio.com/AAOS/AAOM/WebView?OP=ID&ID=750ce91e-84f4-4fe3-bdad-203058ddb67c
420-123	SNF	420	1	SG	3' 0"	6' 8"	1 3/4"	90	26.38M.69.4(4")SW.			https://www.openingsstudio.com/AAOS/AAOM/WebView?OP=ID&ID=4062f4d2-83e2-4a6c-adbb-0960e76644b9
420-124	SNF	420	1	SG	3' 8"	6' 8"	1 3/4"	20	55.95HL/03.69. 5.KP.WP			https://www.openingsstudio.com/AAOS/AAOM/WebView?OP=ID&ID=22b36080-a928-409a-bf7c-bad1d3c3b4d7
420-125	SNF	420	1	SG	3' 0"	6' 8"	1 3/4"	20	55.95HL/03.69. 5.KP.WP			https://www.openingsstudio.com/AAOS/AAOM/WebView?OP=ID&ID=2e013c67-e503-4fa0-b5ee-35ef61d27d6d
420-126	SNF	420	1	SG	3' 0"	6' 8"	1 3/4"	20	56.04M.69.4(4")			https://www.openingsstudio.com/AAOS/AAOM/WebView?OP=ID&ID=0cab0340-aae4-4244-a865-486c3702ee66
420-127	SNF	420	1	SG	3' 8"	6' 8"	1 3/4"	20	56.05M.69.5.K P.WP			https://www.openingsstudio.com/AAOS/AAOM/WebView?OP=ID&ID=5cbb0528-7acc-4afe-b6e2-640c3a91052d
420-128	SNF	420	1	SG	3' 8"	6' 8"	1 3/4"	20	56.05M.69.5.K P.WP.MHO			https://www.openingsstudio.com/AAOS/AAOM/WebView?OP=ID&ID=8d343123-a362-4ac6-8079-0d5d90fe918e
420-129	SNF	420	1	SG	3' 8"	6' 8"	1 3/4"	20	56.05M.69.5.K P.WP.MHO			https://www.openingsstudio.com/AAOS/AAOM/WebView?OP=ID&ID=476b4ad3-5bfa-4273-b883-b4c39022df71
420-130	SNF	420	1	SG	3' 8"	6' 8"	1 3/4"	20	56.05M.69.5.K P.WP.MHO			https://www.openingsstudio.com/AAOS/AAOM/WebView?OP=ID&ID=d4459ade-cadf-46ad-84e4-2a25ba5d94a4
420-132	SNF	420	1	SG	3' 0"	6' 8"	1 3/4"	20	56.04M.69.7.			https://www.openingsstudio.com/AAOS/AAOM/WebView?OP=ID&ID=d7d2a284-28c0-4487-8c2a-054a54c4552b
420-133	SNF	420	1	SG	3' 8"	6' 8"	1 3/4"	20	56.38M.69.5.K P.WP			https://www.openingsstudio.com/AAOS/AAOM/WebView?OP=ID&ID=5fd1aada-8a94-4b28-aa61-871fae608a97
420-134	SNF	420	1	SG	3' 0"	6' 8"	1 3/4"	20	56.38M/03C.69 .7			https://www.openingsstudio.com/AAOS/AAOM/WebView?OP=ID&ID=8b1e8a2a-2996-49e4-acf5-0101155f8deb
420-135	SNF	420	1	SG	3' 8"	6' 8"	1 3/4"	20	55.95HL/03.69. 5.KP.WP			https://www.openingsstudio.com/AAOS/AAOM/WebView?OP=ID&ID=6a74778b-c07b-4e06-9ca9-e5d506d4ef97
420-136	SNF	420	1	SG	3' 8"	6' 8"	1 3/4"	20	55.37M.69.5.K P.WP.MHO			https://www.openingsstudio.com/AAOS/AAOM/WebView?OP=ID&ID=17bd7746-545e-452c-8e48-56d14a07dfb8
420-137	SNF	420	1	SG	3' 0"	6' 8"	1 3/4"	20	56.04M.69.7.W P			https://www.openingsstudio.com/AAOS/AAOM/WebView?OP=ID&ID=69262a66-efec-4848-b950-8ed5b89dff4a
420-139	SNF	420	1	SG	3' 8"	6' 8"	1 3/4"	20	56.04M.69.7.K P.WP			https://www.openingsstudio.com/AAOS/AAOM/WebView?OP=ID&ID=de60defa-4860-4e4e-b6ed-18e46fb80f1c
420-140	SNF	420	1	SG	3' 0"	6' 8"	1 3/4"	20	55.37M.69.7.W P			https://www.openingsstudio.com/AAOS/AAOM/WebView?OP=ID&ID=523d2915-7775-4d1f-802d-1abd23534561
420-141	SNF	420	1	SG	3' 0"	6' 8"	1 3/4"	20	56.04M.69.7.K P.WP			https://www.openingsstudio.com/AAOS/AAOM/WebView?OP=ID&ID=c5438843-c871-402d-9db5-0ad9daf9355a
420-142	SNF	420	1	SG	3' 0"	6' 8"	1 3/4"	20	56.04M/04C.69 .7.MHO			https://www.openingsstudio.com/AAOS/AAOM/WebView?OP=ID&ID=596be4b9-fd86-433d-9fa1-a9b2ab0180e3
420-143	SNF	420	1	SG	3' 0"	6' 8"	1 3/4"	20	56.38M/03C.69 .7.KP			https://www.openingsstudio.com/AAOS/AAOM/WebView?OP=ID&ID=15b7e847-d775-4331-99fd-10fe781607e3
420-144	SNF	420	1	SG	3' 0"	6' 8"	1 3/4"	None	56.38M/03C.69 .7			https://www.openingsstudio.com/AAOS/AAOM/WebView?OP=ID&ID=5317ae8a-bed0-4021-ace5-7b80ed72a29f
420-145	SNF	420	1	SG	3' 0"	6' 8"	1 3/4"	20	56.04M.69.7.W P			https://www.openingsstudio.com/AAOS/AAOM/WebView?OP=ID&ID=ec0d2a29-6b4c-4e34-9103-700c93b15c98
420-146	SNF	420	1	SG	3' 0"	6' 8"	1 3/4"	20	56.04M.69.4(4")WP			https://www.openingsstudio.com/AAOS/AAOM/WebView?OP=ID&ID=83be12d1-de3d-4655-827c-5d6e39b0ee27
420-147	SNF	420	1	SG	2' 6"	6' 8"	1 3/4"	20	56.04M.69.4(4")2			https://www.openingsstudio.com/AAOS/AAOM/WebView?OP=ID&ID=3630818c-b4d9-4b28-93ac-5b6580d91775

080610 - Door Schedule Report

Project Name: DSH-METROPOLITAN SNF BLDG

Project ID: 196636

420-148	SNF	420	1	AI	4' 0"	6' 8"	1 3/4"	20	56.04M.41.4(4") .AF.KP.AS			https://www.openingsstudio.com/AAOS/AAOM/WebView?OP=ID&ID=9fc24c7f-4258-40fe-a128-c240bd28fc61
420-149	SNF	420	1	SG	3' 0"	6' 8"	1 3/4"	None	55.95HL/03.50. 7.WP			https://www.openingsstudio.com/AAOS/AAOM/WebView?OP=ID&ID=2bcb38c-3f5e-40af-9368-fc682121b72f
420-150	SNF	420	1	SG	3' 8"	6' 8"	1 3/4"	20	56.05M.69.5.K P.WP.MHO			https://www.openingsstudio.com/AAOS/AAOM/WebView?OP=ID&ID=83a2973e-9a82-4f59-a5e6-d902a5ab8103
420-151	SNF	420	1	SG	3' 8"	6' 8"	1 3/4"	20	56.04M.69.5.W P.MHO			https://www.openingsstudio.com/AAOS/AAOM/WebView?OP=ID&ID=76214367-781a-4653-b161-4e0a8fb8196
420-152	SNF	420	1	SG	3' 8"	6' 8"	1 3/4"	20	56.05M.69.5.K P.WP.MHO			https://www.openingsstudio.com/AAOS/AAOM/WebView?OP=ID&ID=88415ca2-2aff-45a9-884c-847ad1afc5d2
420-153	SNF	420	1	SG	3' 8"	6' 8"	1 3/4"	20	56.05M.69.5.K P.WP.MHO			https://www.openingsstudio.com/AAOS/AAOM/WebView?OP=ID&ID=20c7e81f-7059-4d24-9924-3d27f6029019
420-154	SNF	420	1	SG	3' 8"	6' 8"	1 3/4"	20	56.05M.69.5.K P.WP.MHO			https://www.openingsstudio.com/AAOS/AAOM/WebView?OP=ID&ID=67393a5c-f336-41eb-b3a3-162904f5fe80
420-155	SNF	420	1	SG	3' 8"	6' 8"	1 3/4"	20	56.05M.69.5.K P.WP.MHO			https://www.openingsstudio.com/AAOS/AAOM/WebView?OP=ID&ID=49305690-f55a-43b6-a170-f37483049364
420-156	SNF	420	1	SG	3' 0"	6' 8"	1 3/4"	20	56.04M.69.7.W P			https://www.openingsstudio.com/AAOS/AAOM/WebView?OP=ID&ID=30286c45-6574-47a0-bca6-eadc08aa9172
420-157	SNF	420	1	SG	3' 0"	6' 8"	1 3/4"	20	56.04M.69.7.K P			https://www.openingsstudio.com/AAOS/AAOM/WebView?OP=ID&ID=93830725-2938-47dd-9189-812e24d515fa
420-158	SNF	420	1	SG	3' 0"	6' 8"	1 3/4"	20	56.04M.69.4(4") (3)			https://www.openingsstudio.com/AAOS/AAOM/WebView?OP=ID&ID=dee60966-f44d-43bf-b425-ef5a930f88db
420-162	SNF	420	1	SG	3' 0"	6' 8"	1 3/4"	20	56.04M.69.4(4") (6)			https://www.openingsstudio.com/AAOS/AAOM/WebView?OP=ID&ID=7cd033ed-288a-44b5-ad13-12e145c9c43f
420-C100	SNF	420	1	DE	6' 0"	6' 8"	1 3/4"	20	45.10.69.5.T.S V.KP.EG.MHO			https://www.openingsstudio.com/AAOS/AAOM/WebView?OP=ID&ID=f24d38c5-afd2-4a41-bcf4-3de2a700c47f
A-101	SNF	A	1	SG	3' 8"	6' 8"	1 3/4"		26.38M.69.1			https://www.openingsstudio.com/AAOS/AAOM/WebView?OP=ID&ID=480d7519-6d64-42bf-bdce-baacceb54286
A-102	SNF	A	1	SG	3' 0"	6' 8"	1 3/4"	None	56.04M/03C.69 .7.KP			https://www.openingsstudio.com/AAOS/AAOM/WebView?OP=ID&ID=a31e159c-1f65-41df-a19c-daa5b83636c8
A-103	SNF	A	1	SG	3' 0"	6' 8"	1 3/4"	20	56.04M.69.5.K P.WP			https://www.openingsstudio.com/AAOS/AAOM/WebView?OP=ID&ID=a23e5717-2128-4b60-b87a-eea2477a3ae5
A-104	SNF	A	1	SG	3' 0"	6' 8"	1 3/4"		56.04M.50.4(4x 4).			https://www.openingsstudio.com/AAOS/AAOM/WebView?OP=ID&ID=d96a2aa0-b4d5-41ed-a97e-b8816efb7359
A-105	SNF	A	1	SG	3' 0"	6' 8"	1 3/4"		56.04M.50.4(4x 4).			https://www.openingsstudio.com/AAOS/AAOM/WebView?OP=ID&ID=74af2981-5b66-4206-86f9-ea7681b0bda0
A-114	SNF	A	1	SG	2' 6"	6' 8"	1 3/4"	20	56.04M.50.4(4x 4).			https://www.openingsstudio.com/AAOS/AAOM/WebView?OP=ID&ID=1055e923-6302-4584-9444-1f5874de2665
A-116	SNF	A	1	SG	2' 6"	6' 8"	1 3/4"	20	56.04M.50.4(4x 4).			https://www.openingsstudio.com/AAOS/AAOM/WebView?OP=ID&ID=aa00c8b8-9931-4e92-96c8-303a68cb1fec
A-118	SNF	A	1	SG	2' 6"	6' 8"	1 3/4"	20	56.04M/03.64.4 (4x4).KP.PP			https://www.openingsstudio.com/AAOS/AAOM/WebView?OP=ID&ID=085b202c-905b-46c2-932f-f269a907b46c
A-119	SNF	A	1	SG	3' 6"	6' 8"	1 3/4"	20	56.04M.64.5.			https://www.openingsstudio.com/AAOS/AAOM/WebView?OP=ID&ID=492fbff3-e18b-4098-9e57-6fb2afae064b
A-120A	SNF	A	1	AI	6' 0"	7' 0"	1 3/4"		26.38M/99.00.1 .S.MF.			https://www.openingsstudio.com/AAOS/AAOM/WebView?OP=ID&ID=7a75e77b-ebec-414b-9f70-0e0742a142cd
A-120B	SNF	A	1	SG	3' 10"	6' 8"	1 3/4"	20	56.38M.69.5.K P.AP			https://www.openingsstudio.com/AAOS/AAOM/WebView?OP=ID&ID=4266e05e-080e-4708-a761-9f236058298a
A-120C	SNF	A	1	AI	6' 0"	7' 0"	1 3/4"		26.38M/99.00.1 .S.MF.			https://www.openingsstudio.com/AAOS/AAOM/WebView?OP=ID&ID=4a4f12e9-aa59-427a-a35a-99dc90a027e2
A-122	SNF	A	1	SG	2' 6"	6' 8"	1 3/4"	20	56.04M.64.4(4"))			https://www.openingsstudio.com/AAOS/AAOM/WebView?OP=ID&ID=3c31c6d7-11de-4dae-8697-4b49446d4203

080610 - Door Schedule Report

Project Name: DSH-METROPOLITAN SNF BLDG

Project ID: 196636

A-123	SNF	A	1	SG	2' 6"	6' 8"	1 3/4"	20	56.04M.69.4(4")			https://www.openingsstudio.com/AAOS/AAOM/WebView?OP=ID&ID=96135362-a7c0-45df-943f-597bf1bb396f
A-124	SNF	A	1	SG	2' 6"	6' 8"	1 3/4"	20	56.04M.69.4(4")			https://www.openingsstudio.com/AAOS/AAOM/WebView?OP=ID&ID=69ab25fd-9692-444e-ba0c-265ac6403785
A-131B	SNF	A	1	SG	3' 8"	6' 8"	1 3/4"		56.38M.69.1.E G			https://www.openingsstudio.com/AAOS/AAOM/WebView?OP=ID&ID=2a7d25a1-fd6d-460d-b9a1-a6f7b92fa889
A-136A	SNF	A	1	SG	3' 0"	6' 8"	1 3/4"		25.38M.69.3.S W.T.KP			https://www.openingsstudio.com/AAOS/AAOM/WebView?OP=ID&ID=8c7dadd7-a518-4b52-8bdb-03dfbb3a77f3
A-136B	SNF	A	1	SG	3' 0"	6' 8"	1 3/4"	60	56.04M.69.7			https://www.openingsstudio.com/AAOS/AAOM/WebView?OP=ID&ID=4e83d04f-fc00-47f3-a6d7-767e354ed2ed
A-136C	SNF	A	1	SG	3' 10"	6' 8"	1 3/4"	20	56.38M.69.5.K P.AP			https://www.openingsstudio.com/AAOS/AAOM/WebView?OP=ID&ID=2e338bd4-0c6e-4a49-8d29-3870119fab0c
A-136D	SNF	A	1	AI	6' 0"	7' 0"	1 3/4"		26.38M/99.00.1 .S.MF.			https://www.openingsstudio.com/AAOS/AAOM/WebView?OP=ID&ID=d9134d74-896b-4146-b637-c8989235621d
A-142A	SNF	A	1	AI	7' 0"	7' 0"	1 3/4"		26.04M.00.5.M F.KP.			https://www.openingsstudio.com/AAOS/AAOM/WebView?OP=ID&ID=fe15ee21-d4e7-4868-91f1-4dbb7f13342b
A-142B	SNF	A	1	SG	3' 0"	6' 8"	1 3/4"	20	56.04M.61.5.			https://www.openingsstudio.com/AAOS/AAOM/WebView?OP=ID&ID=fb9ccee4-806a-4fcc-be34-0a4bbd6903dd
A-143A	SNF	A	1	SG	3' 6"	6' 8"	1 3/4"	20	56.38M.69.5.K P.			https://www.openingsstudio.com/AAOS/AAOM/WebView?OP=ID&ID=b5399e29-dca1-468b-9bdc-37454d685333
A-143B	SNF	A	1	SG	3' 6"	6' 8"	1 3/4"	20	56.38M.69.5.K P.			https://www.openingsstudio.com/AAOS/AAOM/WebView?OP=ID&ID=0bcb51d4-6adb-4b86-a7d2-ac8f08213d08
A-145	SNF	A	1	SG	3' 0"	6' 8"	1 3/4"		56.04M.69.4(4")			https://www.openingsstudio.com/AAOS/AAOM/WebView?OP=ID&ID=99ff9c61-7d0a-483e-bb6d-a9767a703472
A-146	SNF	A	1	SG	3' 0"	6' 8"	1 3/4"		56.04M.69.4(4")			https://www.openingsstudio.com/AAOS/AAOM/WebView?OP=ID&ID=7e51c42b-d934-4dad-8720-1260ae15c89e
A-147A	SNF	A	1	SG	3' 8"	6' 8"	1 3/4"	20	56.38M.69.5.A P.PP			https://www.openingsstudio.com/AAOS/AAOM/WebView?OP=ID&ID=16f78880-24a4-4382-af4b-e9e0c06ba062
A-147B	SNF	A	1	SG	3' 8"	6' 8"	1 3/4"	20	56.38M.69.5.A P.PP			https://www.openingsstudio.com/AAOS/AAOM/WebView?OP=ID&ID=d1d0fd00-2868-4392-96d9-4b739ddc1cd6
A-148A	SNF	A	1	SG	3' 8"	6' 8"	1 3/4"	20	56.38M.69.5.K P.			https://www.openingsstudio.com/AAOS/AAOM/WebView?OP=ID&ID=24c4f4fc-8961-4805-9e6c-1a52ee80dad3
A-148B	SNF	A	1	SG	3' 8"	6' 8"	1 3/4"	20	56.38M.69.5.K P.			https://www.openingsstudio.com/AAOS/AAOM/WebView?OP=ID&ID=4df6f35b-7386-4e54-9184-9728981777d3
A-149	SNF	A	1	SG	3' 6"	6' 8"	1 3/4"	20	55.04KPL.50.5			https://www.openingsstudio.com/AAOS/AAOM/WebView?OP=ID&ID=39fe7996-bb6e-4dea-8854-3be35151fc53
A-150	SNF	A	1	SG	3' 0"	6' 8"	1 3/4"		56.04M.69.4(4")			https://www.openingsstudio.com/AAOS/AAOM/WebView?OP=ID&ID=cb1e0722-9708-4190-8ab5-b2a68461bfef
A-151	SNF	A	1	SG	3' 0"	6' 8"	1 3/4"	20	56.04M.50.4(4x 4).			https://www.openingsstudio.com/AAOS/AAOM/WebView?OP=ID&ID=d6d6688e-e8c4-44c1-8d79-faff741f0b64
A-159	SNF	A	1	SG	3' 0"	6' 8"	1 3/4"	20	56.04M.69.4(4")			https://www.openingsstudio.com/AAOS/AAOM/WebView?OP=ID&ID=fddc9830-7a45-4c66-aafa-e1cb89b582fb
A-160	SNF	A	1	SG	3' 6"	6' 8"	1 3/4"	20	56.04M.50.4(4x 4).			https://www.openingsstudio.com/AAOS/AAOM/WebView?OP=ID&ID=239ab0ff-af41-4e6e-8318-a9ef0d0154b2
A-160A	SNF	A	1	AI	6' 0"	7' 0"	1 3/4"		26.04M.00.5.M F.T.AS			https://www.openingsstudio.com/AAOS/AAOM/WebView?OP=ID&ID=ec9b9cc5-de0c-4603-abf5-d02eb283d404
A-161	SNF	A	1	SG	2' 6"	6' 8"	1 3/4"	20	56.04M.50.4(4x 4).			https://www.openingsstudio.com/AAOS/AAOM/WebView?OP=ID&ID=89c38897-f61e-44b0-b6f6-45d70e1ccab5
A-418	SNF	A	1	SG	3' 10"	6' 8"	1 3/4"		56.38M.69.1.E G			https://www.openingsstudio.com/AAOS/AAOM/WebView?OP=ID&ID=f6947bb4-0b6b-46e9-afdd-211dd5f2e640
A-419	SNF	A	1	SG	3' 8"	6' 8"	1 3/4"		56.38M.69.1.E G			https://www.openingsstudio.com/AAOS/AAOM/WebView?OP=ID&ID=b3321149-299a-401e-bc4b-9bdc4b8abf08

080610 - Door Schedule Report

Project Name: DSH-METROPOLITAN SNF BLDG

Project ID: 196636

A-420	SNF	A	1	SG	3' 10"	6' 8"	1 3/4"	None	56.38M.69.1.E G				https://www.openingsstudio.com/AAOS/AAOM/WebView?OP=ID&ID=dec9900e-93a5-4e22-b58e-1171cdc1ba90
-------	-----	---	---	----	--------	-------	--------	------	--------------------	--	--	--	---

Corrective Action Report

Mark	Usage	Building	Level	To Room	Fire/Smoke Rating	Hardware Set	Opening Remarks	Opening Issue Code	Inspection Date	Issue Type	Issue Comment	Corrective Action	Issue Status	Opening Status	Survey Status	Priority
417-101A		SNF	417		20	56.38M.69.7 KP.WP		D9 : Improper field modification or repair	10-18-2023	Punch Inspection		Replace	Non-Compliant	Non-Compliant		
417-101B		SNF	417			26.38M/99.1 1PB.5.TH.M F.KP.(1)		O2 : Door does not close completely	10-18-2023	Punch Inspection	Active door doesn't close	Adjust	Non-Compliant	Non-Compliant		
417-101C		SNF	417		None	26.38M/99.1 1PB.5.MF.K P.AS		D1 : Rust-through on door	10-18-2023	Punch Inspection	Significant rush through on active door	Replace	Non-Compliant	Non-Compliant		
417-101C		SNF	417		None	26.38M/99.1 1PB.5.MF.K P.AS		D2 : Door damaged (bent, dented, delaminating)	10-18-2023	Punch Inspection	Inactive door is doing it at the bottom of strike side	Replace	Non-Compliant	Non-Compliant		
417-101C		SNF	417		None	26.38M/99.1 1PB.5.MF.K P.AS		F2 : Damaged/rust through on frame	10-18-2023	Punch Inspection		Replace	Non-Compliant	Non-Compliant		
417-101C		SNF	417		None	26.38M/99.1 1PB.5.MF.K P.AS		O5 : Door drags on floor, rubs frame/rubs other door	10-18-2023	Punch Inspection	Rubs other door towards the bottom of stile	N/A	Non-Compliant	Non-Compliant		
417-101D		SNF	417		None	26.38M/99.1 1PB.5/5HS TH.KP.		D2 : Door damaged (bent, dented, delaminating)	10-18-2023	Punch Inspection	Weld broke, dented	Replace	Non-Compliant	Non-Compliant		
417-101E		SNF	417		20	56.38M.69.7 KP.		D2 : Door damaged (bent, dented, delaminating)	10-18-2023	Punch Inspection		Replace	Non-Compliant	Non-Compliant		
417-101E		SNF	417		20	56.38M.69.7 KP.		D3 : Missing/painted/illegible label	10-18-2023	Punch Inspection	Painted	N/A	Non-Compliant	Non-Compliant		
417-101E		SNF	417		20	56.38M.69.7 KP.		D4 : Incorrect/missing/broken glass	10-18-2023	Punch Inspection	Non-rated glass	N/A	Non-Compliant	Non-Compliant		
417-101E		SNF	417		20	56.38M.69.7 KP.		F4 : Missing/painted/illegible label	10-18-2023	Punch Inspection	Painted	Contact ASSA ABLOY for field labeling	Non-Compliant	Non-Compliant		
417-102		SNF	417		60	56.38M.50.4 (4x4).		D2 : Door damaged (bent, dented, delaminating)	10-18-2023	Punch Inspection		Replace	Non-Compliant	Non-Compliant		
417-102		SNF	417		60	56.38M.50.4 (4x4).		F4 : Missing/painted/illegible label	10-18-2023	Punch Inspection	Missing	Contact ASSA ABLOY for field labeling	Non-Compliant	Non-Compliant		
417-103		SNF	417			99.0		D0 : Door not installed	10-18-2023	Punch Inspection		N/A	Non-Compliant	Non-Compliant		
417-104A		SNF	417		20	56.04M.69.7 WP		D9 : Improper field modification or repair	10-18-2023	Punch Inspection		Replace	Non-Compliant	Non-Compliant		
417-104B		SNF	417			56.38M.50.7 /4(4.5SP).M F		D2 : Door damaged (bent, dented, delaminating)	10-18-2023	Punch Inspection		Replace	Non-Compliant	Non-Compliant		
417-107A		SNF	417		20	56.38M.69.7 KP.WP		D2 : Door damaged (bent, dented, delaminating)	10-18-2023	Punch Inspection		Replace	Non-Compliant	Non-Compliant		
417-107A		SNF	417		20	56.38M.69.7 KP.WP		D9 : Improper field modification or repair	10-18-2023	Punch Inspection		N/A	Non-Compliant	Non-Compliant		
417-108		SNF	417		20	26.38M.69.7 SW.		D3 : Missing/painted/illegible label	10-18-2023	Punch Inspection	Painted	Contact ASSA ABLOY for field labeling	Non-Compliant	Non-Compliant		

417-108	SNF	417	20	26.38M.69.7 SW.	F4 : Missing/painted/illegible label	10-18-2023	Punch Inspection	Painted	Contact ASSA ABLOY for field labeling	Non- Compliant	Non- Compliant
417-109	SNF	417	20	56.04M.69.7 MF	D2 : Door damaged (bent, dented, delaminating)	10-18-2023	Punch Inspection		Replace	Non- Compliant	Non- Compliant
417-110	SNF	417	20	56.04M.69.7 WP	D2 : Door damaged (bent, dented, delaminating)	10-18-2023	Punch Inspection		Replace	Non- Compliant	Non- Compliant
417-111	SNF	417	20	56.04M.69.7 WP	D2 : Door damaged (bent, dented, delaminating)	10-18-2023	Punch Inspection		Replace	Non- Compliant	Non- Compliant
417-112	SNF	417	20	55.95HL/03 69.5.KP.WP	D9 : Improper field modification or repair	10-18-2023	Punch Inspection		Replace	Non- Compliant	Non- Compliant
417-113	SNF	417	20	56.38M.69.7 WP	D9 : Improper field modification or repair	10-18-2023	Punch Inspection		Replace	Non- Compliant	Non- Compliant
417-114	SNF	417	20	56.04M.69.5 KP.WP	D9 : Improper field modification or repair	10-18-2023	Punch Inspection		Replace	Non- Compliant	Non- Compliant
417-115	SNF	417	20	55.95HL/03 69.5.KP.WP MHO	D9 : Improper field modification or repair	10-18-2023	Punch Inspection		Repair, Replace	Non- Compliant	Non- Compliant
417-115	SNF	417	20	55.95HL/03 69.5.KP.WP MHO	F4 : Missing/painted/illegible label	10-18-2023	Punch Inspection	Missing	Contact ASSA ABLOY for field labeling	Non- Compliant	Non- Compliant
417-116	SNF	417	20	55.95HL/03 69.5.KP.WP MHO	D9 : Improper field modification or repair	10-18-2023	Punch Inspection		Replace	Non- Compliant	Non- Compliant
417-116	SNF	417	20	55.95HL/03 69.5.KP.WP MHO	F4 : Missing/painted/illegible label	10-18-2023	Punch Inspection	Missing	Contact ASSA ABLOY for field labeling	Non- Compliant	Non- Compliant
417-117	SNF	417	20	55.95HL/03 69.5.KP.WP MHO	D9 : Improper field modification or repair	10-18-2023	Punch Inspection		Replace	Non- Compliant	Non- Compliant
417-117	SNF	417	20	55.95HL/03 69.5.KP.WP MHO	F4 : Missing/painted/illegible label	10-18-2023	Punch Inspection	Missing	Contact ASSA ABLOY for field labeling	Non- Compliant	Non- Compliant
417-118	SNF	417	20	55.95HL/03 69.5.KP.WP MHO	D9 : Improper field modification or repair	10-18-2023	Punch Inspection		Replace	Non- Compliant	Non- Compliant
417-118	SNF	417	20	55.95HL/03 69.5.KP.WP MHO	F4 : Missing/painted/illegible label	10-18-2023	Punch Inspection	Missing	Contact ASSA ABLOY for field labeling	Non- Compliant	Non- Compliant
417-119	SNF	417	20	56.04M.69.7	D2 : Door damaged (bent, dented, delaminating)	10-18-2023	Punch Inspection		Replace	Non- Compliant	Non- Compliant
417-119	SNF	417	20	56.04M.69.7	D9 : Improper field modification or repair	10-18-2023	Punch Inspection		Replace	Non- Compliant	Non- Compliant
417-120	SNF	417	60	56.04M.69.7 KP.WP	D2 : Door damaged (bent, dented, delaminating)	10-18-2023	Punch Inspection		Replace	Non- Compliant	Non- Compliant
417-120	SNF	417	60	56.04M.69.7 KP.WP	D9 : Improper field modification or repair	10-18-2023	Punch Inspection		Replace	Non- Compliant	Non- Compliant
417-120	SNF	417	60	56.04M.69.7 KP.WP	F4 : Missing/painted/illegible label	10-18-2023	Punch Inspection	Painted	Contact ASSA ABLOY for field labeling	Non- Compliant	Non- Compliant
417-121	SNF	417	20	56.38M.69.7	D2 : Door damaged (bent, dented, delaminating)	10-18-2023	Punch Inspection		Repair	Non- Compliant	Non- Compliant

417-121	SNF	417	20	56.38M.69.7	D9 : Improper field modification or repair	10-18-2023	Punch Inspection		Replace	Non-Compliant	Non-Compliant
417-121	SNF	417	20	56.38M.69.7	F4 : Missing/painted/illegible label	10-18-2023	Punch Inspection	Defaced	Contact ASSA ABLOY for field labeling	Non-Compliant	Non-Compliant
417-122	SNF	417	20	56.04M.69.4 (4")	D2 : Door damaged (bent, dented, delaminating)	10-18-2023	Punch Inspection		Replace	Non-Compliant	Non-Compliant
417-122	SNF	417	20	56.04M.69.4 (4")	D9 : Improper field modification or repair	10-18-2023	Punch Inspection		Replace	Non-Compliant	Non-Compliant
417-123	SNF	417	None	26.38M.69.7 SW.	O12 : Door blocked	10-18-2023	Punch Inspection		N/A	Non-Compliant	Non-Compliant
417-123	SNF	417	None	26.38M.69.7 SW.	O5 : Door drags on floor, rubs frame/rubs other door	10-18-2023	Punch Inspection	Can see where the door is rubbing on the frame oh strike side near the top	N/A	Non-Compliant	Non-Compliant
417-124	SNF	417	20	55.95HL/03.69.5.KP.WP	D2 : Door damaged (bent, dented, delaminating)	10-18-2023	Punch Inspection		Replace	Non-Compliant	Non-Compliant
417-124	SNF	417	20	55.95HL/03.69.5.KP.WP	D9 : Improper field modification or repair	10-18-2023	Punch Inspection		Replace	Non-Compliant	Non-Compliant
417-124	SNF	417	20	55.95HL/03.69.5.KP.WP	F4 : Missing/painted/illegible label	10-18-2023	Punch Inspection	Missing	Contact ASSA ABLOY for field labeling	Non-Compliant	Non-Compliant
417-125	SNF	417	20	55.95HL/03.69.5.KP.WP	D2 : Door damaged (bent, dented, delaminating)	10-18-2023	Punch Inspection		Replace	Non-Compliant	Non-Compliant
417-125	SNF	417	20	55.95HL/03.69.5.KP.WP	D9 : Improper field modification or repair	10-18-2023	Punch Inspection		N/A	Non-Compliant	Non-Compliant
417-126	SNF	417	20	56.04M.69.7 KP.WP	D9 : Improper field modification or repair	10-18-2023	Punch Inspection		Replace	Non-Compliant	Non-Compliant
417-126	SNF	417	20	56.04M.69.7 KP.WP	F4 : Missing/painted/illegible label	10-18-2023	Punch Inspection	Painted	Contact ASSA ABLOY for field labeling	Non-Compliant	Non-Compliant
417-126	SNF	417	20	56.04M.69.7 KP.WP	O2 : Door does not close completely	10-18-2023	Punch Inspection	Wrap around plate prevent door from closing completely	N/A	Non-Compliant	Non-Compliant
417-127	SNF	417	20	55.95HL/03.69.5.KP.WP	D2 : Door damaged (bent, dented, delaminating)	10-18-2023	Punch Inspection		Replace	Non-Compliant	Non-Compliant
417-127	SNF	417	20	55.95HL/03.69.5.KP.WP	D9 : Improper field modification or repair	10-18-2023	Punch Inspection		Replace	Non-Compliant	Non-Compliant
417-127	SNF	417	20	55.95HL/03.69.5.KP.WP	F4 : Missing/painted/illegible label	10-18-2023	Punch Inspection	Missing	Contact ASSA ABLOY for field labeling	Non-Compliant	Non-Compliant
419-128	SNF	419	20	55.95HL.69.5.KP.WP.M HO	D9 : Improper field modification or repair	10-17-2023	Punch Inspection		Replace	Non-Compliant	Non-Compliant
419-128	SNF	419	20	55.95HL.69.5.KP.WP.M HO	F4 : Missing/painted/illegible label	10-17-2023	Punch Inspection	Missing	Contact ASSA ABLOY for field labeling	Non-Compliant	Non-Compliant
419-129	SNF	419	20	55.95HL.69.5.KP.WP.M HO	D9 : Improper field modification or repair	10-17-2023	Punch Inspection		Replace	Non-Compliant	Non-Compliant
419-129	SNF	419	20	55.95HL.69.5.KP.WP.M HO	F4 : Missing/painted/illegible label	10-17-2023	Punch Inspection	Missing	Contact ASSA ABLOY for field labeling	Non-Compliant	Non-Compliant

419-130	SNF	419	20	55.95HL.69.5.KP.WP.MHO	D9 : Improper field modification or repair	10-17-2023	Punch Inspection		Replace	Non-Compliant	Non-Compliant
419-130	SNF	419	20	55.95HL.69.5.KP.WP.MHO	F4 : Missing/painted/illegible label	10-17-2023	Punch Inspection	Painted	Contact ASSA ABLOY for field labeling	Non-Compliant	Non-Compliant
417-131A	SNF	417	20	56.38M.69.7.WP	D2 : Door damaged (bent, dented, delaminating)	10-18-2023	Punch Inspection		Replace	Non-Compliant	Non-Compliant
417-131A	SNF	417	20	56.38M.69.7.WP	D9 : Improper field modification or repair	10-18-2023	Punch Inspection		N/A	Non-Compliant	Non-Compliant
417-132	SNF	417	20	56.04M.69.5.WP	D2 : Door damaged (bent, dented, delaminating)	10-18-2023	Punch Inspection		Replace	Non-Compliant	Non-Compliant
417-132	SNF	417	20	56.04M.69.5.WP	D9 : Improper field modification or repair	10-18-2023	Punch Inspection		Replace	Non-Compliant	Non-Compliant
417-133	SNF	417	20	55.95HL/03.69.5.KP.WP	D2 : Door damaged (bent, dented, delaminating)	10-18-2023	Punch Inspection		Replace	Non-Compliant	Non-Compliant
417-133	SNF	417	20	55.95HL/03.69.5.KP.WP	D9 : Improper field modification or repair	10-18-2023	Punch Inspection		Replace	Non-Compliant	Non-Compliant
417-133	SNF	417	20	55.95HL/03.69.5.KP.WP	F4 : Missing/painted/illegible label	10-18-2023	Punch Inspection	Missing	Contact ASSA ABLOY for field labeling	Non-Compliant	Non-Compliant
417-134	SNF	417	20	56.38M/03.69.7.WP	D2 : Door damaged (bent, dented, delaminating)	10-18-2023	Punch Inspection		Replace	Non-Compliant	Non-Compliant
417-134	SNF	417	20	56.38M/03.69.7.WP	D9 : Improper field modification or repair	10-18-2023	Punch Inspection		N/A	Non-Compliant	Non-Compliant
417-135	SNF	417	20	55.95HL/03.69.5.KP.WP	D2 : Door damaged (bent, dented, delaminating)	10-18-2023	Punch Inspection		Replace	Non-Compliant	Non-Compliant
417-135	SNF	417	20	55.95HL/03.69.5.KP.WP	D9 : Improper field modification or repair	10-18-2023	Punch Inspection		N/A	Non-Compliant	Non-Compliant
417-135	SNF	417	20	55.95HL/03.69.5.KP.WP	F4 : Missing/painted/illegible label	10-18-2023	Punch Inspection	Missing	Contact ASSA ABLOY for field labeling	Non-Compliant	Non-Compliant
417-136	SNF	417	20	55.95HL/03.69.5.KP.WP.MHO	D2 : Door damaged (bent, dented, delaminating)	10-18-2023	Punch Inspection		Replace	Non-Compliant	Non-Compliant
417-136	SNF	417	20	55.95HL/03.69.5.KP.WP.MHO	D9 : Improper field modification or repair	10-18-2023	Punch Inspection		N/A	Non-Compliant	Non-Compliant
417-136	SNF	417	20	55.95HL/03.69.5.KP.WP.MHO	F4 : Missing/painted/illegible label	10-18-2023	Punch Inspection	Missing	Contact ASSA ABLOY for field labeling	Non-Compliant	Non-Compliant
417-137	SNF	417	20	56.04M.69.7.WP	D2 : Door damaged (bent, dented, delaminating)	10-18-2023	Punch Inspection		Replace	Non-Compliant	Non-Compliant
417-137	SNF	417	20	56.04M.69.7.WP	D9 : Improper field modification or repair	10-18-2023	Punch Inspection		Replace	Non-Compliant	Non-Compliant
417-137	SNF	417	20	56.04M.69.7.WP	F4 : Missing/painted/illegible label	10-18-2023	Punch Inspection	Painted	Contact ASSA ABLOY for field labeling	Non-Compliant	Non-Compliant
417-139	SNF	417	20	55.95HL/03.69.5.KP.WP	D2 : Door damaged (bent, dented, delaminating)	10-18-2023	Punch Inspection		Replace	Non-Compliant	Non-Compliant

417-139	SNF	417	20	55.95HL/03 69.5.KP.WP	D9 : Improper field modification or repair	10-18-2023	Punch Inspection		N/A	Non- Compliant	Non- Compliant
417-139	SNF	417	20	55.95HL/03 69.5.KP.WP	F4 : Missing/painted/illegible label	10-18-2023	Punch Inspection	Missing	Contact ASSA ABLOY for field labeling	Non- Compliant	Non- Compliant
417-140	SNF	417	20	56.38M.69.7 WP	D9 : Improper field modification or repair	10-18-2023	Punch Inspection		N/A	Non- Compliant	Non- Compliant
417-140	SNF	417	20	56.38M.69.7 WP	F4 : Missing/painted/illegible label	10-18-2023	Punch Inspection	Painted	Contact ASSA ABLOY for field labeling	Non- Compliant	Non- Compliant
417-141	SNF	417	20	56.04M.69.7 WP	D2 : Door damaged (bent, dented, delaminating)	10-18-2023	Punch Inspection		Replace	Non- Compliant	Non- Compliant
417-142	SNF	417	20	56.04M/04C 69.7.MHO	F4 : Missing/painted/illegible label	10-18-2023	Punch Inspection	Painted	Contact ASSA ABLOY for field labeling	Non- Compliant	Non- Compliant
417-143	SNF	417	20	56.38M/03C 69.7.KP.W P	D2 : Door damaged (bent, dented, delaminating)	10-18-2023	Punch Inspection		Replace	Non- Compliant	Non- Compliant
417-143	SNF	417	20	56.38M/03C 69.7.KP.W P	D9 : Improper field modification or repair	10-18-2023	Punch Inspection		N/A	Non- Compliant	Non- Compliant
417-143	SNF	417	20	56.38M/03C 69.7.KP.W P	F4 : Missing/painted/illegible label	10-18-2023	Punch Inspection	Painted	Contact ASSA ABLOY for field labeling	Non- Compliant	Non- Compliant
417-144	SNF	417		56.38M/03C 69.7.WP	D2 : Door damaged (bent, dented, delaminating)	10-18-2023	Punch Inspection		Replace	Non- Compliant	Non- Compliant
417-145	SNF	417	20	56.04M.69.7 KP.WP	D2 : Door damaged (bent, dented, delaminating)	10-18-2023	Punch Inspection		Replace	Non- Compliant	Non- Compliant
417-145	SNF	417	20	56.04M.69.7 KP.WP	D9 : Improper field modification or repair	10-18-2023	Punch Inspection		N/A	Non- Compliant	Non- Compliant
417-145	SNF	417	20	56.04M.69.7 KP.WP	F4 : Missing/painted/illegible label	10-18-2023	Punch Inspection	Painted	Contact ASSA ABLOY for field labeling	Non- Compliant	Non- Compliant
417-146	SNF	417	20	56.04M.69.7 KP.WP	D2 : Door damaged (bent, dented, delaminating)	10-18-2023	Punch Inspection		Replace	Non- Compliant	Non- Compliant
417-146	SNF	417	20	56.04M.69.7 KP.WP	D9 : Improper field modification or repair	10-18-2023	Punch Inspection		Replace	Non- Compliant	Non- Compliant
417-146	SNF	417	20	56.04M.69.7 KP.WP	F4 : Missing/painted/illegible label	10-18-2023	Punch Inspection	Missing	Contact ASSA ABLOY for field labeling	Non- Compliant	Non- Compliant
417-147	SNF	417	60	56.04M.69.4 (4").KP	D2 : Door damaged (bent, dented, delaminating)	10-18-2023	Punch Inspection		Replace	Non- Compliant	Non- Compliant
417-148	SNF	417	20	56.04M.41.4 (4").AF.KP. AS	D2 : Door damaged (bent, dented, delaminating)	10-18-2023	Punch Inspection	Both doors	Replace	Non- Compliant	Non- Compliant
417-148	SNF	417	20	56.04M.41.4 (4").AF.KP. AS	F4 : Missing/painted/illegible label	10-18-2023	Punch Inspection	Missing	Contact ASSA ABLOY for field labeling	Non- Compliant	Non- Compliant
417-148	SNF	417	20	56.04M.41.4 (4").AF.KP. AS	O5 : Door drags on floor, rubs frame/rubs other door	10-18-2023	Punch Inspection	Top of door, rubs top of frame at strike side on an active door	N/A	Non- Compliant	Non- Compliant

417-149	SNF	417			55.95HL/03 50.7.KP.WP	D2 : Door damaged (bent, dented, delaminating)	10-18-2023	Punch Inspection		Replace	Non-Compliant	Non-Compliant
417-150	SNF	417	20		56.05M.69.5 KP.WP.MH O	D2 : Door damaged (bent, dented, delaminating)	10-18-2023	Punch Inspection		Replace	Non-Compliant	Non-Compliant
417-150	SNF	417	20		56.05M.69.5 KP.WP.MH O	D9 : Improper field modification or repair	10-18-2023	Punch Inspection		N/A	Non-Compliant	Non-Compliant
417-150	SNF	417	20		56.05M.69.5 KP.WP.MH O	F2 : Damaged/rust through on frame	10-18-2023	Punch Inspection		Replace	Non-Compliant	Non-Compliant
417-150	SNF	417	20		56.05M.69.5 KP.WP.MH O	F4 : Missing/painted/illegible label	10-18-2023	Punch Inspection	Missing	N/A	Non-Compliant	Non-Compliant
417-151	SNF	417	20		56.05M.69.5 KP.WP.MH O	D2 : Door damaged (bent, dented, delaminating)	10-18-2023	Punch Inspection	Damaged and warped	Replace	Non-Compliant	Non-Compliant
417-151	SNF	417	20		56.05M.69.5 KP.WP.MH O	D9 : Improper field modification or repair	10-18-2023	Punch Inspection		N/A	Non-Compliant	Non-Compliant
417-151	SNF	417	20		56.05M.69.5 KP.WP.MH O	F4 : Missing/painted/illegible label	10-18-2023	Punch Inspection	Missing	Contact ASSA ABLOY for field labeling	Non-Compliant	Non-Compliant
417-152	SNF	417	20		55.95HL/03 69.5.KP.WP MHO(1)	D9 : Improper field modification or repair	10-19-2023	Punch Inspection	Wrap plate installed	Replace	Non-Compliant	Non-Compliant
417-152	SNF	417	20		55.95HL/03 69.5.KP.WP MHO(1)	F4 : Missing/painted/illegible label	10-19-2023	Punch Inspection	Missing	Contact ASSA ABLOY for field labeling	Non-Compliant	Non-Compliant
417-152	SNF	417	20		55.95HL/03 69.5.KP.WP MHO(1)	O5 : Door drags on floor, rubs frame/rubs other door	10-19-2023	Punch Inspection	Rubs on frame	N/A	Non-Compliant	Non-Compliant
417-153	SNF	417	20		55.95HL/03 69.5.KP.WP MHO	D2 : Door damaged (bent, dented, delaminating)	10-18-2023	Punch Inspection		Replace	Non-Compliant	Non-Compliant
417-153	SNF	417	20		55.95HL/03 69.5.KP.WP MHO	D9 : Improper field modification or repair	10-18-2023	Punch Inspection		Replace	Non-Compliant	Non-Compliant
417-153	SNF	417	20		55.95HL/03 69.5.KP.WP MHO	F4 : Missing/painted/illegible label	10-18-2023	Punch Inspection	Missing	Contact ASSA ABLOY for field labeling	Non-Compliant	Non-Compliant
417-154	SNF	417	20		55.95HL/03 69.5.KP.WP MHO	D2 : Door damaged (bent, dented, delaminating)	10-18-2023	Punch Inspection		Replace	Non-Compliant	Non-Compliant
417-154	SNF	417	20		55.95HL/03 69.5.KP.WP MHO	D9 : Improper field modification or repair	10-18-2023	Punch Inspection		N/A	Non-Compliant	Non-Compliant
417-154	SNF	417	20		55.95HL/03 69.5.KP.WP MHO	F4 : Missing/painted/illegible label	10-18-2023	Punch Inspection	Missing	Contact ASSA ABLOY for field labeling	Non-Compliant	Non-Compliant
417-155	SNF	417	20		55.95HL/03 69.5.KP.WP MHO	D2 : Door damaged (bent, dented, delaminating)	10-18-2023	Punch Inspection		Replace	Non-Compliant	Non-Compliant
417-155	SNF	417	20		55.95HL/03 69.5.KP.WP MHO	D9 : Improper field modification or repair	10-18-2023	Punch Inspection		N/A	Non-Compliant	Non-Compliant

417-155	SNF	417	20	55.95HL/03.69.5.KP.WP.MHO	F4 : Missing/painted/illegible label	10-18-2023	Punch Inspection	Missing	Contact ASSA ABLOY for field labeling	Non-Compliant	Non-Compliant
417-156	SNF	417	20	56.04M.69.7.KP.WP	D2 : Door damaged (bent, dented, delaminating)	10-18-2023	Punch Inspection		Replace	Non-Compliant	Non-Compliant
417-156	SNF	417	20	56.04M.69.7.KP.WP	D9 : Improper field modification or repair	10-18-2023	Punch Inspection		Replace	Non-Compliant	Non-Compliant
417-156	SNF	417	20	56.04M.69.7.KP.WP	F4 : Missing/painted/illegible label	10-18-2023	Punch Inspection	Painted	Contact ASSA ABLOY for field labeling	Non-Compliant	Non-Compliant
417-157	SNF	417	20	56.04M.69.7.KP.WP	D9 : Improper field modification or repair	10-18-2023	Punch Inspection		Replace	Non-Compliant	Non-Compliant
417-157	SNF	417	20	56.04M.69.7.KP.WP	F4 : Missing/painted/illegible label	10-18-2023	Punch Inspection	Painted	Contact ASSA ABLOY for field labeling	Non-Compliant	Non-Compliant
417-C100	SNF	417	20	45.10.69.5.T.SV.KP.E.G.MHO	D2 : Door damaged (bent, dented, delaminating)	10-18-2023	Punch Inspection		Replace	Non-Compliant	Non-Compliant
417-C100	SNF	417	20	45.10.69.5.T.SV.KP.E.G.MHO	F4 : Missing/painted/illegible label	10-18-2023	Punch Inspection	Painted	Contact ASSA ABLOY for field labeling	Non-Compliant	Non-Compliant
418-101A	SNF	418	20	56.38M.69.7	D2 : Door damaged (bent, dented, delaminating)	10-19-2023	Punch Inspection		Replace	Non-Compliant	Non-Compliant
418-101A	SNF	418	20	56.38M.69.7	F4 : Missing/painted/illegible label	10-19-2023	Punch Inspection	Illegible	Contact ASSA ABLOY for field labeling	Non-Compliant	Non-Compliant
418-101A	SNF	418	20	56.38M.69.7	O2 : Door does not close completely	10-19-2023	Punch Inspection	Blocked by a strike that has been modified	N/A	Non-Compliant	Non-Compliant
418-101B	SNF	418		26.38M/99.69.6.TH.MF.KP.DB.AS(1)	D2 : Door damaged (bent, dented, delaminating)	10-18-2023	Punch Inspection		Replace	Non-Compliant	Non-Compliant
418-101E	SNF	418	20	56.38M.69.7.KP.(1)	D2 : Door damaged (bent, dented, delaminating)	10-19-2023	Punch Inspection	Door split	Replace	Non-Compliant	Non-Compliant
418-102	SNF	418	60	56.04M.50.4(4x4).	D2 : Door damaged (bent, dented, delaminating)	10-18-2023	Punch Inspection		Replace	Non-Compliant	Non-Compliant
418-102	SNF	418	60	56.04M.50.4(4x4).	F2 : Damaged/rust through on frame	10-18-2023	Punch Inspection	Both legs	Replace	Non-Compliant	Non-Compliant
418-102	SNF	418	60	56.04M.50.4(4x4).	F3 : Frame is out of alignment	10-18-2023	Punch Inspection		N/A	Non-Compliant	Non-Compliant
418-102	SNF	418	60	56.04M.50.4(4x4).	F4 : Missing/painted/illegible label	10-18-2023	Punch Inspection	Missing	N/A	Non-Compliant	Non-Compliant
418-102	SNF	418	60	56.04M.50.4(4x4).	O5 : Door drags on floor, rubs frame/rubs other door	10-18-2023	Punch Inspection	Top of door rubs top of frame.	N/A	Non-Compliant	Non-Compliant
418-103	SNF	418		99.0	D0 : Door not installed	10-18-2023	Punch Inspection		N/A	Non-Compliant	Non-Compliant
418-104A	SNF	418	20	56.04M.69.7.AP	D2 : Door damaged (bent, dented, delaminating)	10-18-2023	Punch Inspection		Replace	Non-Compliant	Non-Compliant
418-104B	SNF	418	20	56.04M.69.7	D2 : Door damaged (bent, dented, delaminating)	10-18-2023	Punch Inspection		Replace	Non-Compliant	Non-Compliant

418-104B	SNF	418	20	56.04M.69.7	F4 : Missing/painted/illegible label	10-18-2023	Punch Inspection		Contact ASSA ABLOY for field labeling	Non-Compliant	Non-Compliant
418-107	SNF	418		26.04M.A.6 9.5.TH.KP. DC.DB(2)	O2 : Door does not close completely	10-19-2023	Punch Inspection		Adjust	Non-Compliant	Non-Compliant
418-108	SNF	418	90	26.04M.69.7 SW.	D2 : Door damaged (bent, dented, delaminating)	10-19-2023	Punch Inspection		Replace	Non-Compliant	Non-Compliant
418-109	SNF	418	20	56.04M.69.7 MF.AS	D2 : Door damaged (bent, dented, delaminating)	10-19-2023	Punch Inspection		Replace	Non-Compliant	Non-Compliant
418-110	SNF	418	20	56.04M.69.4 (4")	D2 : Door damaged (bent, dented, delaminating)	10-19-2023	Punch Inspection		Replace	Non-Compliant	Non-Compliant
418-111	SNF	418	20	56.04M.69.5	D2 : Door damaged (bent, dented, delaminating)	10-19-2023	Punch Inspection		Replace	Non-Compliant	Non-Compliant
418-112	SNF	418	20	55.95HL/03 69.5.KP.WP	D9 : Improper field modification or repair	10-19-2023	Punch Inspection		Replace	Non-Compliant	Non-Compliant
418-113	SNF	418	20	56.04M.69.7	D2 : Door damaged (bent, dented, delaminating)	10-19-2023	Punch Inspection		Replace	Non-Compliant	Non-Compliant
418-115	SNF	418	20	55.95HL.69 5.KP.WP(5)	D9 : Improper field modification or repair	10-19-2023	Punch Inspection		Replace	Non-Compliant	Non-Compliant
418-116	SNF	418	20	56.04M.69.5 WP.MHO	D9 : Improper field modification or repair	10-19-2023	Punch Inspection		Replace	Non-Compliant	Non-Compliant
418-117	SNF	418	20	55.95HL.69 5.KP.WP.M HO	D9 : Improper field modification or repair	10-19-2023	Punch Inspection		Replace	Non-Compliant	Non-Compliant
418-118	SNF	418	20	55.95HL.69 5.KP.WP.M HO	D9 : Improper field modification or repair	10-19-2023	Punch Inspection		Replace	Non-Compliant	Non-Compliant
418-118	SNF	418	20	55.95HL.69 5.KP.WP.M HO	O5 : Door drags on floor, rubs frame/rubs other door	10-19-2023	Punch Inspection	Rubs on frame	N/A	Non-Compliant	Non-Compliant
418-121	SNF	418	20	56.04M.69.7 WP	D9 : Improper field modification or repair	10-19-2023	Punch Inspection		Replace	Non-Compliant	Non-Compliant
418-122	SNF	418	20	56.04M.69.4 (4")	D2 : Door damaged (bent, dented, delaminating)	10-19-2023	Punch Inspection		Replace	Non-Compliant	Non-Compliant
418-123	SNF	420	90	26.38M.69.4 (4").SW.	D2 : Door damaged (bent, dented, delaminating)	10-19-2023	Punch Inspection	Dented	Replace	Non-Compliant	Non-Compliant
418-123	SNF	420	90	26.38M.69.4 (4").SW.	O5 : Door drags on floor, rubs frame/rubs other door	10-19-2023	Punch Inspection	Door rubs on frame at bottom strike side	N/A	Non-Compliant	Non-Compliant
418-124	SNF	418	20	55.95HL/03 69.5.KP.WP	D2 : Door damaged (bent, dented, delaminating)	10-19-2023	Punch Inspection		Replace	Non-Compliant	Non-Compliant
418-124	SNF	418	20	55.95HL/03 69.5.KP.WP	D9 : Improper field modification or repair	10-19-2023	Punch Inspection		N/A	Non-Compliant	Non-Compliant
418-124	SNF	418	20	55.95HL/03 69.5.KP.WP	F4 : Missing/painted/illegible label	10-19-2023	Punch Inspection	Label has been removed.	Contact ASSA ABLOY for field labeling	Non-Compliant	Non-Compliant

418-125	SNF	418	20	55.95HL.69.5.KP.WP(2)	D2 : Door damaged (bent, dented, delaminating)	10-19-2023	Punch Inspection		Replace	Non-Compliant	Non-Compliant
418-125	SNF	418	20	55.95HL.69.5.KP.WP(2)	D9 : Improper field modification or repair	10-19-2023	Punch Inspection		N/A	Non-Compliant	Non-Compliant
418-126	SNF	418	20	56.04M.69.5	D2 : Door damaged (bent, dented, delaminating)	10-19-2023	Punch Inspection		Replace	Non-Compliant	Non-Compliant
418-127	SNF	418	20	55.95HL.69.5.KP.WP(1)	D2 : Door damaged (bent, dented, delaminating)	10-19-2023	Punch Inspection		Replace	Non-Compliant	Non-Compliant
418-127	SNF	418	20	55.95HL.69.5.KP.WP(1)	D9 : Improper field modification or repair	10-19-2023	Punch Inspection		N/A	Non-Compliant	Non-Compliant
418-127	SNF	418	20	55.95HL.69.5.KP.WP(1)	F4 : Missing/painted/illegible label	10-19-2023	Punch Inspection	Missing	Contact ASSA ABLOY for field labeling	Non-Compliant	Non-Compliant
418-128	SNF	418	20	55.95HL.69.5.KP.WP(3)	D2 : Door damaged (bent, dented, delaminating)	10-19-2023	Punch Inspection		Replace	Non-Compliant	Non-Compliant
418-128	SNF	418	20	55.95HL.69.5.KP.WP(3)	D9 : Improper field modification or repair	10-19-2023	Punch Inspection		N/A	Non-Compliant	Non-Compliant
418-128	SNF	418	20	55.95HL.69.5.KP.WP(3)	F4 : Missing/painted/illegible label	10-19-2023	Punch Inspection	Label has been removed	Contact ASSA ABLOY for field labeling	Non-Compliant	Non-Compliant
418-129	SNF	418	20	55.95HL.69.5.KP.WP(6)	D2 : Door damaged (bent, dented, delaminating)	10-19-2023	Punch Inspection		Replace	Non-Compliant	Non-Compliant
418-130	SNF	418	20	55.95HL.69.5.KP.WP(4)	D2 : Door damaged (bent, dented, delaminating)	10-19-2023	Punch Inspection		Replace	Non-Compliant	Non-Compliant
418-130	SNF	418	20	55.95HL.69.5.KP.WP(4)	F4 : Missing/painted/illegible label	10-19-2023	Punch Inspection	Illegible	Contact ASSA ABLOY for field labeling	Non-Compliant	Non-Compliant
418-130	SNF	418	20	55.95HL.69.5.KP.WP(4)	O5 : Door drags on floor, rubs frame/rubs other door	10-19-2023	Punch Inspection	Wrap plate rubs on frame	N/A	Non-Compliant	Non-Compliant
418-132	SNF	418	20	56.04M.69.7	D2 : Door damaged (bent, dented, delaminating)	10-19-2023	Punch Inspection		Replace	Non-Compliant	Non-Compliant
418-133	SNF	418	20	55.95HL/03.69.5.KP.WP	D2 : Door damaged (bent, dented, delaminating)	10-19-2023	Punch Inspection		Replace	Non-Compliant	Non-Compliant
418-133	SNF	418	20	55.95HL/03.69.5.KP.WP	D9 : Improper field modification or repair	10-19-2023	Punch Inspection		Replace	Non-Compliant	Non-Compliant
418-133	SNF	418	20	55.95HL/03.69.5.KP.WP	F4 : Missing/painted/illegible label	10-19-2023	Punch Inspection	Missing	Contact ASSA ABLOY for field labeling	Non-Compliant	Non-Compliant
418-134	SNF	418	20	56.38M/03C.69.7	D2 : Door damaged (bent, dented, delaminating)	10-18-2023	Punch Inspection		Replace	Non-Compliant	Non-Compliant
418-135	SNF	418	20	55.95HL/03.69.5.KP.WP.MHO	D9 : Improper field modification or repair	10-18-2023	Punch Inspection		Replace	Non-Compliant	Non-Compliant
418-136	SNF	418	20	55.95HL.69.5.KP.WP.MHO	D9 : Improper field modification or repair	10-18-2023	Punch Inspection		Replace	Non-Compliant	Non-Compliant

418-139	SNF	418	20	55.95HL.69.5.WP	D2 : Door damaged (bent, dented, delaminating)	10-18-2023	Punch Inspection		Replace	Non-Compliant	Non-Compliant
418-139	SNF	418	20	55.95HL.69.5.WP	F4 : Missing/painted/illegible label	10-18-2023	Punch Inspection	Missing	Contact ASSA ABLOY for field labeling	Non-Compliant	Non-Compliant
418-140	SNF	418	20	56.04M.69.7.KP	D2 : Door damaged (bent, dented, delaminating)	10-18-2023	Punch Inspection		Replace	Non-Compliant	Non-Compliant
418-141	SNF	418	20	56.04M.69.7.KP	D2 : Door damaged (bent, dented, delaminating)	10-18-2023	Punch Inspection		Replace	Non-Compliant	Non-Compliant
418-144	SNF	418	20	56.38M.50.7.WP	D9 : Improper field modification or repair	10-18-2023	Punch Inspection		Replace	Non-Compliant	Non-Compliant
418-144	SNF	418	20	56.38M.50.7.WP	F4 : Missing/painted/illegible label	10-18-2023	Punch Inspection	Painted	Contact ASSA ABLOY for field labeling	Non-Compliant	Non-Compliant
418-145	SNF	418	20	56.04M.69.7.KP	D2 : Door damaged (bent, dented, delaminating)	10-18-2023	Punch Inspection	Door split	Replace	Non-Compliant	Non-Compliant
418-146	SNF	418	60	56.04M.69.4(4")	D2 : Door damaged (bent, dented, delaminating)	10-18-2023	Punch Inspection		Replace	Non-Compliant	Non-Compliant
418-146	SNF	418	60	56.04M.69.4(4")	F2 : Damaged/rust through on frame	10-18-2023	Punch Inspection		Replace	Non-Compliant	Non-Compliant
418-147	SNF	418	20	56.04M.69.4(4")(1)	D9 : Improper field modification or repair	10-18-2023	Punch Inspection		Replace	Non-Compliant	Non-Compliant
418-148	SNF	418	20	56.04M.69.4(4").MF.AS	D2 : Door damaged (bent, dented, delaminating)	10-19-2023	Punch Inspection		Replace	Non-Compliant	Non-Compliant
418-149	SNF	418	20	55.95HL/03.50.7.WP	D9 : Improper field modification or repair	10-18-2023	Punch Inspection		Replace	Non-Compliant	Non-Compliant
418-149	SNF	418	20	55.95HL/03.50.7.WP	F4 : Missing/painted/illegible label	10-18-2023	Punch Inspection	Missing	Contact ASSA ABLOY for field labeling	Non-Compliant	Non-Compliant
418-150	SNF	418	20	56.37M.69.5	D2 : Door damaged (bent, dented, delaminating)	10-18-2023	Punch Inspection		Replace	Non-Compliant	Non-Compliant
418-151	SNF	418	20	56.04M.69.5	D2 : Door damaged (bent, dented, delaminating)	10-18-2023	Punch Inspection	Door split	Replace	Non-Compliant	Non-Compliant
418-152	SNF	418	20	55.95HL.69.5.WP.MHO	D9 : Improper field modification or repair	10-18-2023	Punch Inspection		Replace	Non-Compliant	Non-Compliant
418-153	SNF	418	20	55.95HL.69.5.KP.WP.MHO	D9 : Improper field modification or repair	10-18-2023	Punch Inspection		Replace	Non-Compliant	Non-Compliant
418-154	SNF	418	20	55.95HL.69.5.KP.WP.MHO	D9 : Improper field modification or repair	10-18-2023	Punch Inspection		Replace	Non-Compliant	Non-Compliant
418-155	SNF	418	20	55.95HL.69.5.KP.WP.MHO	D9 : Improper field modification or repair	10-18-2023	Punch Inspection		Replace	Non-Compliant	Non-Compliant
418-162	SNF	418	20	56.04M.69.7	D2 : Door damaged (bent, dented, delaminating)	10-19-2023	Punch Inspection		Replace	Non-Compliant	Non-Compliant
418-C100	SNF	418	20	45.10.69.5.T.SV.KP.E.G.MHO	D2 : Door damaged (bent, dented, delaminating)	10-18-2023	Punch Inspection	Both doors split	Replace	Non-Compliant	Non-Compliant

419-101A	SNF	419	20	56.04M.69.7 KP.WP	D9 : Improper field modification or repair	10-17-2023	Punch Inspection		Replace	Non- Compliant	Non- Compliant
419-101B	SNF	419	20	56.38M.69.7 KP.AP	LO10 : Unacceptable quality/material/finish	10-17-2023	Punch Inspection	Missing knob	Replace	Non- Compliant	Non- Compliant
419-101B	SNF	419	20	56.38M.69.7 KP.AP	O1 : Door does not swing freely	10-17-2023	Punch Inspection	Can't open door due to missing knob	N/A	Non- Compliant	Non- Compliant
419-101C	SNF	419		26.38M/99.6 9.5.TH.KP	O1 : Door does not swing freely	10-17-2023	Punch Inspection	Door stuck closed	N/A	Non- Compliant	Non- Compliant
419-101E	SNF	419		26.38M/99.1 1PB.5.TH.M F.KP.	O5 : Door drags on floor, rubs frame/rubs other door	10-17-2023	Punch Inspection	Inactive door rubs on frame	N/A	Non- Compliant	Non- Compliant
419-102	SNF	419	20	56.38M.50.4 (4x4).	D3 : Missing/painted/illegible label	10-17-2023	Punch Inspection	Missing label	Contact ASSA ABLOY for field labeling	Non- Compliant	Non- Compliant
419-102	SNF	419	20	56.38M.50.4 (4x4).	F4 : Missing/painted/illegible label	10-17-2023	Punch Inspection	Missing label	Contact ASSA ABLOY for field labeling	Non- Compliant	Non- Compliant
419-103	SNF	419		99.0	D0 : Door not installed	10-17-2023	Punch Inspection		N/A	Non- Compliant	Non- Compliant
419-103	SNF	419		99.0	F2 : Damaged/rust through on frame	10-17-2023	Punch Inspection		Replace	Non- Compliant	Non- Compliant
419-104A	SNF	419	20	56.38M.69.7 KP.	D3 : Missing/painted/illegible label	10-17-2023	Punch Inspection	Painted	N/A	Non- Compliant	Non- Compliant
419-104A	SNF	419	20	56.38M.69.7 KP.	F4 : Missing/painted/illegible label	10-17-2023	Punch Inspection	Painted	Contact ASSA ABLOY for field labeling	Non- Compliant	Non- Compliant
419-104A	SNF	419	20	56.38M.69.7 KP.	O5 : Door drags on floor, rubs frame/rubs other door	10-17-2023	Punch Inspection	Rubs on frame	Adjust	Non- Compliant	Non- Compliant
419-107A	SNF	419		26.04M.A.6 9.5.TH.KP. DC.DB	LO0 : Lock missing/damaged/not securely fastened	10-17-2023	Punch Inspection	Face plate is split.	Replace Armor Front	Non- Compliant	Non- Compliant
419-108	SNF	419	90	26.04M.69.7 SW.	D2 : Door damaged (bent, dented, delaminating)	10-17-2023	Punch Inspection		Replace	Non- Compliant	Non- Compliant
419-109	SNF	419	20	56.04M.69.7 MF	D2 : Door damaged (bent, dented, delaminating)	10-17-2023	Punch Inspection	Damage on inactive door. See photos.	Replace	Non- Compliant	Non- Compliant
419-109	SNF	419	20	56.04M.69.7 MF	F4 : Missing/painted/illegible label	10-17-2023	Punch Inspection	Label is painted over	Contact ASSA ABLOY for field labeling	Non- Compliant	Non- Compliant
419-110	SNF	419	20	56.04M.69.7	D2 : Door damaged (bent, dented, delaminating)	10-17-2023	Punch Inspection		Replace	Non- Compliant	Non- Compliant
419-111	SNF	419	20	56.04M.69.5 KP.WP	D2 : Door damaged (bent, dented, delaminating)	10-17-2023	Punch Inspection		Replace	Non- Compliant	Non- Compliant
419-112	SNF	419	20	55.95HL/03 69.5.KP.WP	D9 : Improper field modification or repair	10-17-2023	Punch Inspection		Replace	Non- Compliant	Non- Compliant
419-112	SNF	419	20	55.95HL/03 69.5.KP.WP	O5 : Door drags on floor, rubs frame/rubs other door	10-17-2023	Punch Inspection	Call rub frame at bottom	Adjust to function New or Replace	Non- Compliant	Non- Compliant
419-113	SNF	419	20	55.95HL.69 5.T.WP	D9 : Improper field modification or repair	10-17-2023	Punch Inspection		Replace	Non- Compliant	Non- Compliant
419-114	SNF	419	20	56.04M.69.5 KP.WP	D9 : Improper field modification or repair	10-17-2023	Punch Inspection		Replace	Non- Compliant	Non- Compliant

419-115	SNF	419	20	55.95HL.69.5.KP.WP	D9 : Improper field modification or repair	10-17-2023	Punch Inspection		Replace	Non-Compliant	Non-Compliant
419-116	SNF	419	20	55.95HL.69.5.KP.WP.MHO	D9 : Improper field modification or repair	10-17-2023	Punch Inspection		Replace	Non-Compliant	Non-Compliant
419-117	SNF	419	20	55.95HL.69.5.WP.MHO	D9 : Improper field modification or repair	10-17-2023	Punch Inspection		Replace	Non-Compliant	Non-Compliant
419-117	SNF	419	20	55.95HL.69.5.WP.MHO	F4 : Missing/painted/illegible label	10-17-2023	Punch Inspection	Painted Label	Contact ASSA ABLOY for field labeling	Non-Compliant	Non-Compliant
419-118	SNF	419	20	55.95HL.69.5.KP.WP.MHO	D9 : Improper field modification or repair	10-17-2023	Punch Inspection		Replace	Non-Compliant	Non-Compliant
419-120A	SNF	419		26.38M.A.69.5.TH.KP.DC.DB	O1 : Door does not swing freely	10-17-2023	Punch Inspection	When door closes you can't open it back up	N/A	Non-Compliant	Non-Compliant
419-121	SNF	419	90	56.04M.69.7.WP	D9 : Improper field modification or repair	10-17-2023	Punch Inspection		Replace	Non-Compliant	Non-Compliant
419-123	SNF	419	90	26.38M.69.7.SW.	D2 : Door damaged (bent, dented, delaminating)	10-17-2023	Punch Inspection		Replace	Non-Compliant	Non-Compliant
419-124	SNF	419	20	55.95HL/03.69.5.KP.WP	D9 : Improper field modification or repair	10-17-2023	Punch Inspection		Replace	Non-Compliant	Non-Compliant
419-124	SNF	419	20	55.95HL/03.69.5.KP.WP	F4 : Missing/painted/illegible label	10-17-2023	Punch Inspection	Missing	Contact ASSA ABLOY for field labeling	Non-Compliant	Non-Compliant
419-125	SNF	419	20	55.95HL.69.5.KP.WP	D9 : Improper field modification or repair	10-17-2023	Punch Inspection		Replace	Non-Compliant	Non-Compliant
419-127	SNF	419	20	55.95HL.69.5.KP.WP	D2 : Door damaged (bent, dented, delaminating)	10-17-2023	Punch Inspection		Replace	Non-Compliant	Non-Compliant
419-127	SNF	419	20	55.95HL.69.5.KP.WP	D9 : Improper field modification or repair	10-17-2023	Punch Inspection		Replace	Non-Compliant	Non-Compliant
419-127	SNF	419	20	55.95HL.69.5.KP.WP	F4 : Missing/painted/illegible label	10-17-2023	Punch Inspection	Missing	Contact ASSA ABLOY for field labeling	Non-Compliant	Non-Compliant
417-128	SNF	417	20	55.95HL/03.69.5.KP.WP	D9 : Improper field modification or repair	10-18-2023	Punch Inspection		Replace	Non-Compliant	Non-Compliant
417-128	SNF	417	20	55.95HL/03.69.5.KP.WP	F4 : Missing/painted/illegible label	10-18-2023	Punch Inspection	Missing	Contact ASSA ABLOY for field labeling	Non-Compliant	Non-Compliant
417-129	SNF	417	20	56.05M.69.5.KP.WP	D2 : Door damaged (bent, dented, delaminating)	10-18-2023	Punch Inspection		Replace	Non-Compliant	Non-Compliant
417-129	SNF	417	20	56.05M.69.5.KP.WP	D9 : Improper field modification or repair	10-18-2023	Punch Inspection		Replace	Non-Compliant	Non-Compliant
417-129	SNF	417	20	56.05M.69.5.KP.WP	F4 : Missing/painted/illegible label	10-18-2023	Punch Inspection	Missing	Contact ASSA ABLOY for field labeling	Non-Compliant	Non-Compliant
417-130	SNF	417	20	55.95HL/03.69.5.KP.WP	D2 : Door damaged (bent, dented, delaminating)	10-18-2023	Punch Inspection		Replace	Non-Compliant	Non-Compliant
417-130	SNF	417	20	55.95HL/03.69.5.KP.WP	D9 : Improper field modification or repair	10-18-2023	Punch Inspection		N/A	Non-Compliant	Non-Compliant

417-130	SNF	417	20	55.95HL/03 69.5.KP.WP	F4 : Missing/painted/illegible label	10-18-2023	Punch Inspection	Missing	Contact ASSA ABLOY for field labeling	Non- Compliant	Non- Compliant	
419-132	SNF	419	20	56.04M.69.7	D2 : Door damaged (bent, dented, delaminating)	10-17-2023	Punch Inspection	Split at hinges	Replace	Non- Compliant	Non- Compliant	
419-132	SNF	419	20	56.04M.69.7	D3 : Missing/painted/illegible label	10-17-2023	Punch Inspection	Label missing	Contact ASSA Abloy for field labeling	Non- Compliant	Non- Compliant	
419-132	SNF	419	20	56.04M.69.7	F2 : Damaged/rust through on frame	10-17-2023	Punch Inspection	Rust through at bottom of brain	Replace	Non- Compliant	Non- Compliant	
419-132	SNF	419	20	56.04M.69.7	F4 : Missing/painted/illegible label	10-17-2023	Punch Inspection	Painted	N/A	Non- Compliant	Non- Compliant	
419-132	SNF	419	20	56.04M.69.7	O5 : Door drags on floor, rubs frame/rubs other door	10-17-2023	Punch Inspection	Rubs on strike side	Adjust to function New or Replace	Non- Compliant	Non- Compliant	
419-133	SNF	419	20	55.95HL/03 69.5.KP.WP	D2 : Door damaged (bent, dented, delaminating)	10-17-2023	Punch Inspection	Damages , non water related	Replace	Non- Compliant	Non- Compliant	
419-133	SNF	419	20	55.95HL/03 69.5.KP.WP	D9 : Improper field modification or repair	10-17-2023	Punch Inspection		N/A	Non- Compliant	Non- Compliant	
419-134	SNF	419	20	56.38M/03C 69.7	D2 : Door damaged (bent, dented, delaminating)	10-17-2023	Punch Inspection	Water damage	Replace	Non- Compliant	Non- Compliant	
419-135	SNF	419	20	55.95HL/03 69.5.KP.WP	D9 : Improper field modification or repair	10-17-2023	Punch Inspection		Replace	Non- Compliant	Non- Compliant	
419-135	SNF	419	20	55.95HL/03 69.5.KP.WP	F4 : Missing/painted/illegible label	10-17-2023	Punch Inspection	Label missing.	Contact ASSA ABLOY for field labeling	Non- Compliant	Non- Compliant	
419-136	SNF	419	20	55.95HL.69 5.KP.WP	D2 : Door damaged (bent, dented, delaminating)	10-17-2023	Punch Inspection		Replace	Non- Compliant	Non- Compliant	Not Accessible
419-136	SNF	419	20	55.95HL.69 5.KP.WP	D8 : Unused fastener holes/wrong door prep	10-17-2023	Punch Inspection		Replace	Non- Compliant	Non- Compliant	Not Accessible
419-136	SNF	419	20	55.95HL.69 5.KP.WP	F4 : Missing/painted/illegible label	10-17-2023	Punch Inspection	Missing label	Contact ASSA Abloy for field labeling	Non- Compliant	Non- Compliant	Not Accessible
419-139	SNF	419	20	55.95HL.69 5.KP.WP	D9 : Improper field modification or repair	10-17-2023	Punch Inspection		Replace	Non- Compliant	Non- Compliant	
419-139	SNF	419	20	55.95HL.69 5.KP.WP	O5 : Door drags on floor, rubs frame/rubs other door	10-17-2023	Punch Inspection	Rubs at top strike corner	N/A	Non- Compliant	Non- Compliant	
419-140	SNF	419	20	56.04M.69.7 KP	D2 : Door damaged (bent, dented, delaminating)	10-17-2023	Punch Inspection		Replace	Non- Compliant	Non- Compliant	
419-141	SNF	419	20	56.04M.69.7 KP.WP	D2 : Door damaged (bent, dented, delaminating)	10-17-2023	Punch Inspection		Replace	Non- Compliant	Non- Compliant	
419-141	SNF	419	20	56.04M.69.7 KP.WP	D9 : Improper field modification or repair	10-17-2023	Punch Inspection		Replace	Non- Compliant	Non- Compliant	
419-141	SNF	419	20	56.04M.69.7 KP.WP	F4 : Missing/painted/illegible label	10-17-2023	Punch Inspection	Timestamp is painted over	Contact ASSA ABLOY for field labeling	Non- Compliant	Non- Compliant	
419-141	SNF	419	20	56.04M.69.7 KP.WP	LO0 : Lock missing/damaged/not securely fastened	10-17-2023	Punch Inspection	Exterior knob is missing	Replace	Non- Compliant	Non- Compliant	

419-142	SNF	419	20	56.04M/04C 69.7	D3 : Missing/painted/illegible label	10-17-2023	Punch Inspection	Label on top door is painted over. There is no label on the bottom of the door.	Contact ASSA ABLOY for field labeling	Non- Compliant	Non- Compliant
419-142	SNF	419	20	56.04M/04C 69.7	D9 : Improper field modification or repair	10-17-2023	Punch Inspection	Appears to have been modified in the field. Appears door was cut in field two separate top from bottom.	N/A	Non- Compliant	Non- Compliant
419-143	SNF	419	20	56.38M/03C 69.7.KP	D2 : Door damaged (bent, dented, delaminating)	10-17-2023	Punch Inspection	Rounding at top hinge side	Replace	Non- Compliant	Non- Compliant
419-145	SNF	419	20	56.04M.69.7 KP	D2 : Door damaged (bent, dented, delaminating)	10-17-2023	Punch Inspection	Multiple areas of damage	Replace	Non- Compliant	Non- Compliant
419-145	SNF	419	20	56.04M.69.7 KP	LO0 : Lock missing/damaged/not securely fastened	10-17-2023	Punch Inspection	Interior and exterior knobs are missing	Repair	Non- Compliant	Non- Compliant
419-146	SNF	419	20	56.04M.69.7	D3 : Missing/painted/illegible label	10-17-2023	Punch Inspection	Missing	Contact ASSA ABLOY for field labeling	Non- Compliant	Non- Compliant
419-146	SNF	419	20	56.04M.69.7	F4 : Missing/painted/illegible label	10-17-2023	Punch Inspection	Missing	Contact ASSA ABLOY for field labeling	Non- Compliant	Non- Compliant
419-147	SNF	419	20	56.04M.69.4 (4")	D2 : Door damaged (bent, dented, delaminating)	10-17-2023	Punch Inspection		Replace	Non- Compliant	Non- Compliant
419-147	SNF	419	20	56.04M.69.4 (4")	F4 : Missing/painted/illegible label	10-17-2023	Punch Inspection	Label missing.	Contact ASSA ABLOY for field labeling	Non- Compliant	Non- Compliant
419-148	SNF	419	20	56.04M.41.7 AF.KP.AP	D2 : Door damaged (bent, dented, delaminating)	10-17-2023	Punch Inspection		Replace	Non- Compliant	Non- Compliant
419-148	SNF	419	20	56.04M.41.7 AF.KP.AP	F4 : Missing/painted/illegible label	10-17-2023	Punch Inspection	Missing	Contact ASSA ABLOY for field labeling	Non- Compliant	Non- Compliant
419-149	SNF	419		55.95HL/03 50.7.WP	O5 : Door drags on floor, rubs frame/rubs other door	10-17-2023	Punch Inspection	Hits frame	N/A	Non- Compliant	Non- Compliant
419-150	SNF	419	20	55.37M.69.5 MHO	D2 : Door damaged (bent, dented, delaminating)	10-17-2023	Punch Inspection		Replace	Non- Compliant	Non- Compliant
419-150	SNF	419	20	55.37M.69.5 MHO	F4 : Missing/painted/illegible label	10-17-2023	Punch Inspection	Painted	Contact ASSA ABLOY for field labeling	Non- Compliant	Non- Compliant
419-151	SNF	419		55.37M.69.5 WP.MHO	D9 : Improper field modification or repair	10-17-2023	Punch Inspection		Replace	Non- Compliant	Non- Compliant
419-151	SNF	419		55.37M.69.5 WP.MHO	F4 : Missing/painted/illegible label	10-17-2023	Punch Inspection	Missing	Contact ASSA ABLOY for field labeling	Non- Compliant	Non- Compliant
419-152	SNF	419	20	55.95HL.69 5.WP.MHO	D9 : Improper field modification or repair	10-17-2023	Punch Inspection		Replace	Non- Compliant	Non- Compliant
419-152	SNF	419	20	55.95HL.69 5.WP.MHO	F4 : Missing/painted/illegible label	10-17-2023	Punch Inspection	Missing	Contact ASSA ABLOY for field labeling	Non- Compliant	Non- Compliant

419-153	SNF	419	20	55.95HL.69.5.KP.WP.MHO	D9 : Improper field modification or repair	10-17-2023	Punch Inspection		Replace	Non-Compliant	Non-Compliant
419-154	SNF	419		55.95HL.69.5.KP.WP.MHO	D9 : Improper field modification or repair	10-17-2023	Punch Inspection		Replace	Non-Compliant	Non-Compliant
419-155	SNF	419	20	55.95HL.69.5.KP.WP.MHO	D2 : Door damaged (bent, dented, delaminating)	10-17-2023	Punch Inspection		Replace	Non-Compliant	Non-Compliant
419-155	SNF	419	20	55.95HL.69.5.KP.WP.MHO	D9 : Improper field modification or repair	10-17-2023	Punch Inspection		Replace	Non-Compliant	Non-Compliant
419-155	SNF	419	20	55.95HL.69.5.KP.WP.MHO	F4 : Missing/painted/illegible label	10-17-2023	Punch Inspection	Missing	Contact ASSA ABLOY for field labeling	Non-Compliant	Non-Compliant
419-156	SNF	419	20	56.04M.69.7.KP	D2 : Door damaged (bent, dented, delaminating)	10-17-2023	Punch Inspection		Replace	Non-Compliant	Non-Compliant
419-157	SNF	419	20	56.04M.69.7.KP	D2 : Door damaged (bent, dented, delaminating)	10-17-2023	Punch Inspection		Replace	Non-Compliant	Non-Compliant
419-158	SNF	419	20	56.04M.69.7	LO1 : Lock missing/damaged/not securely fastened	10-17-2023	Punch Inspection	Faceplate	N/A	Non-Compliant	Non-Compliant
419-162	SNF	419	20	56.04M.69.7	O2 : Door does not close completely	10-17-2023	Punch Inspection	Door hits frame	N/A	Non-Compliant	Non-Compliant
419-C100	SNF	419	20	45.10.69.5.T.SV.KP.E.G.MHO	D2 : Door damaged (bent, dented, delaminating)	10-17-2023	Punch Inspection		Replace	Non-Compliant	Non-Compliant
420-101A	SNF	420	20	56.38M.69.7	D2 : Door damaged (bent, dented, delaminating)	10-18-2023	Punch Inspection		Replace	Non-Compliant	Non-Compliant
420-101A	SNF	420	20	56.38M.69.7	F4 : Missing/painted/illegible label	10-18-2023	Punch Inspection	Painted	Contact ASSA ABLOY for field labeling	Non-Compliant	Non-Compliant
420-101B	SNF	420	20	56.38M.69.7.WP	D2 : Door damaged (bent, dented, delaminating)	10-18-2023	Punch Inspection		Replace	Non-Compliant	Non-Compliant
420-101B	SNF	420	20	56.38M.69.7.WP	D9 : Improper field modification or repair	10-18-2023	Punch Inspection		Replace	Non-Compliant	Non-Compliant
420-101B	SNF	420	20	56.38M.69.7.WP	F4 : Missing/painted/illegible label	10-18-2023	Punch Inspection	Painted	Contact ASSA ABLOY for field labeling	Non-Compliant	Non-Compliant
420-101D	SNF	420	None	26.38M/99.69.5.TH.MF.KP.DB	D1 : Rust-through on door	10-18-2023	Punch Inspection		N/A	Non-Compliant	Non-Compliant
420-101E	SNF	420		26.38M/99.69.5.TH.KP(1)	D1 : Rust-through on door	10-18-2023	Punch Inspection		Replace	Non-Compliant	Non-Compliant
420-102	SNF	420	20	56.38M.50.4(4x4).	D2 : Door damaged (bent, dented, delaminating)	10-18-2023	Punch Inspection		Replace	Non-Compliant	Non-Compliant
420-102	SNF	420	20	56.38M.50.4(4x4).	F4 : Missing/painted/illegible label	10-18-2023	Punch Inspection	Missing	Contact ASSA ABLOY for field labeling	Non-Compliant	Non-Compliant
420-103	SNF	420	None	99.0	D0 : Door not installed	10-18-2023	Punch Inspection		N/A	Non-Compliant	Non-Compliant
420-104A	SNF	420	20	56.04M.69.7.KP.WP	D9 : Improper field modification or repair	10-18-2023	Punch Inspection		Replace	Non-Compliant	Non-Compliant

420-104A	SNF	420	20	56.04M.69.7 KP.WP	F4 : Missing/painted/illegible label	10-18-2023	Punch Inspection	Painted	Contact ASSA ABLOY for field labeling	Non- Compliant	Non- Compliant
420-104B	SNF	420		56.04M.69.1 WP	D2 : Door damaged (bent, dented, delaminating)	10-18-2023	Punch Inspection		Replace	Non- Compliant	Non- Compliant
420-108	SNF	420	90	26.04M.69.7 SW.	D2 : Door damaged (bent, dented, delaminating)	10-18-2023	Punch Inspection		Replace	Non- Compliant	Non- Compliant
420-109	SNF	420	60	56.04M.69.7 MF	D2 : Door damaged (bent, dented, delaminating)	10-18-2023	Punch Inspection		Replace	Non- Compliant	Non- Compliant
420-109	SNF	420	60	56.04M.69.7 MF	F4 : Missing/painted/illegible label	10-18-2023	Punch Inspection	Missing	Contact ASSA ABLOY for field labeling	Non- Compliant	Non- Compliant
420-110	SNF	420	20	56.04M.69.7	D2 : Door damaged (bent, dented, delaminating)	10-18-2023	Punch Inspection		Replace	Non- Compliant	Non- Compliant
420-110	SNF	420	20	56.04M.69.7	F4 : Missing/painted/illegible label	10-18-2023	Punch Inspection	Painted	Contact ASSA ABLOY for field labeling	Non- Compliant	Non- Compliant
420-111	SNF	420	20	56.04M.69.5 WP	D2 : Door damaged (bent, dented, delaminating)	10-18-2023	Punch Inspection		Replace	Non- Compliant	Non- Compliant
420-111	SNF	420	20	56.04M.69.5 WP	D9 : Improper field modification or repair	10-18-2023	Punch Inspection		Replace	Non- Compliant	Non- Compliant
420-111	SNF	420	20	56.04M.69.5 WP	F4 : Missing/painted/illegible label	10-18-2023	Punch Inspection	Missing	Contact ASSA ABLOY for field labeling	Non- Compliant	Non- Compliant
420-112	SNF	420	20	55.95HL/03 69.5.KP.WP	D9 : Improper field modification or repair	10-18-2023	Punch Inspection		Replace	Non- Compliant	Non- Compliant
420-112	SNF	420	20	55.95HL/03 69.5.KP.WP	F4 : Missing/painted/illegible label	10-18-2023	Punch Inspection	Missing	Contact ASSA ABLOY for field labeling	Non- Compliant	Non- Compliant
420-113	SNF	420	20	55.37M.69.7 WP	D2 : Door damaged (bent, dented, delaminating)	10-18-2023	Punch Inspection		Replace	Non- Compliant	Non- Compliant
420-113	SNF	420	20	55.37M.69.7 WP	F4 : Missing/painted/illegible label	10-18-2023	Punch Inspection	Missing	Contact ASSA ABLOY for field labeling	Non- Compliant	Non- Compliant
420-115	SNF	420	20	56.04M.69.5 KP.WP	D2 : Door damaged (bent, dented, delaminating)	10-18-2023	Punch Inspection		Replace	Non- Compliant	Non- Compliant
420-115	SNF	420	20	56.04M.69.5 KP.WP	F4 : Missing/painted/illegible label	10-18-2023	Punch Inspection	Missing	Contact ASSA ABLOY for field labeling	Non- Compliant	Non- Compliant
420-116	SNF	420	20	55.37M.69.5 KP.WP.MH O	D2 : Door damaged (bent, dented, delaminating)	10-18-2023	Punch Inspection		Replace	Non- Compliant	Non- Compliant
420-116	SNF	420	20	55.37M.69.5 KP.WP.MH O	D9 : Improper field modification or repair	10-18-2023	Punch Inspection		Replace	Non- Compliant	Non- Compliant
420-116	SNF	420	20	55.37M.69.5 KP.WP.MH O	F4 : Missing/painted/illegible label	10-18-2023	Punch Inspection	Missing	Contact ASSA ABLOY for field labeling	Non- Compliant	Non- Compliant
420-117	SNF	420	20	55.37M.69.5 KP.WP.MH O	D9 : Improper field modification or repair	10-18-2023	Punch Inspection		Replace	Non- Compliant	Non- Compliant

420-117	SNF	420	20	55.37M.69.5 KP.WP.MH O	F4 : Missing/painted/illegible label	10-18-2023	Punch Inspection	Missing	Contact ASSA ABLOY for field labeling	Non- Compliant	Non- Compliant
420-118	SNF	420	20	55.37M.69.5 KP.WP.MH O	D9 : Improper field modification or repair	10-18-2023	Punch Inspection		Replace	Non- Compliant	Non- Compliant
420-118	SNF	420	20	55.37M.69.5 KP.WP.MH O	F4 : Missing/painted/illegible label	10-18-2023	Punch Inspection	Missing	Contact ASSA ABLOY for field labeling	Non- Compliant	Non- Compliant
420-121	SNF	420	20	56.04M.69.4 (4")(5)	D2 : Door damaged (bent, dented, delaminating)	10-18-2023	Punch Inspection		Replace	Non- Compliant	Non- Compliant
420-122	SNF	420	20	56.04M.69.4 (4")(4)	D2 : Door damaged (bent, dented, delaminating)	10-18-2023	Punch Inspection		Replace	Non- Compliant	Non- Compliant
420-122	SNF	420	20	56.04M.69.4 (4")(4)	F4 : Missing/painted/illegible label	10-18-2023	Punch Inspection	Painted	Contact ASSA ABLOY for field labeling	Non- Compliant	Non- Compliant
420-122	SNF	420	20	56.04M.69.4 (4")(4)	O5 : Door drags on floor, rubs frame/rubs other door	10-18-2023	Punch Inspection	Door rubs frame at top, strike side	N/A	Non- Compliant	Non- Compliant
420-124	SNF	420	20	55.95HL/03 69.5.KP.WP	D2 : Door damaged (bent, dented, delaminating)	10-18-2023	Punch Inspection		Replace	Non- Compliant	Non- Compliant
420-124	SNF	420	20	55.95HL/03 69.5.KP.WP	D9 : Improper field modification or repair	10-18-2023	Punch Inspection		N/A	Non- Compliant	Non- Compliant
420-124	SNF	420	20	55.95HL/03 69.5.KP.WP	F4 : Missing/painted/illegible label	10-18-2023	Punch Inspection	Missing	Contact ASSA ABLOY for field labeling	Non- Compliant	Non- Compliant
420-124	SNF	420	20	55.95HL/03 69.5.KP.WP	O5 : Door drags on floor, rubs frame/rubs other door	10-18-2023	Punch Inspection	Wrap plate rubs frame	N/A	Non- Compliant	Non- Compliant
420-125	SNF	420	20	55.95HL/03 69.5.KP.WP	D2 : Door damaged (bent, dented, delaminating)	10-18-2023	Punch Inspection		Replace	Non- Compliant	Non- Compliant
420-125	SNF	420	20	55.95HL/03 69.5.KP.WP	D3 : Missing/painted/illegible label	10-18-2023	Punch Inspection	Label has been removed	N/A	Non- Compliant	Non- Compliant
420-125	SNF	420	20	55.95HL/03 69.5.KP.WP	D9 : Improper field modification or repair	10-18-2023	Punch Inspection		N/A	Non- Compliant	Non- Compliant
420-125	SNF	420	20	55.95HL/03 69.5.KP.WP	F4 : Missing/painted/illegible label	10-18-2023	Punch Inspection	Painted	Contact ASSA ABLOY for field labeling	Non- Compliant	Non- Compliant
420-125	SNF	420	20	55.95HL/03 69.5.KP.WP	O5 : Door drags on floor, rubs frame/rubs other door	10-18-2023	Punch Inspection	Magh rap plate rubs frame	N/A	Non- Compliant	Non- Compliant
420-126	SNF	420	20	56.04M.69.4 (4")	D2 : Door damaged (bent, dented, delaminating)	10-18-2023	Punch Inspection		Repair	Non- Compliant	Non- Compliant
420-126	SNF	420	20	56.04M.69.4 (4")	D9 : Improper field modification or repair	10-18-2023	Punch Inspection		N/A	Non- Compliant	Non- Compliant
420-127	SNF	420	20	56.05M.69.5 KP.WP	D2 : Door damaged (bent, dented, delaminating)	10-18-2023	Punch Inspection		Replace	Non- Compliant	Non- Compliant
420-127	SNF	420	20	56.05M.69.5 KP.WP	D9 : Improper field modification or repair	10-18-2023	Punch Inspection		N/A	Non- Compliant	Non- Compliant

420-127	SNF	420	20	56.05M.69.5 KP.WP	F4 : Missing/painted/illegible label	10-18-2023	Punch Inspection	Missing	Contact ASSA ABLOY for field labeling	Non- Compliant	Non- Compliant
420-128	SNF	420	20	56.05M.69.5 KP.WP.MH O	D2 : Door damaged (bent, dented, delaminating)	10-18-2023	Punch Inspection		Replace	Non- Compliant	Non- Compliant
420-128	SNF	420	20	56.05M.69.5 KP.WP.MH O	D3 : Missing/painted/illegible label	10-18-2023	Punch Inspection	Door label has been removed.	N/A	Non- Compliant	Non- Compliant
420-128	SNF	420	20	56.05M.69.5 KP.WP.MH O	D9 : Improper field modification or repair	10-18-2023	Punch Inspection		N/A	Non- Compliant	Non- Compliant
420-129	SNF	420	20	56.05M.69.5 KP.WP.MH O	D2 : Door damaged (bent, dented, delaminating)	10-18-2023	Punch Inspection		Replace	Non- Compliant	Non- Compliant
420-129	SNF	420	20	56.05M.69.5 KP.WP.MH O	D3 : Missing/painted/illegible label	10-18-2023	Punch Inspection	Michael has been removed	Replace	Non- Compliant	Non- Compliant
420-129	SNF	420	20	56.05M.69.5 KP.WP.MH O	D9 : Improper field modification or repair	10-18-2023	Punch Inspection		N/A	Non- Compliant	Non- Compliant
420-129	SNF	420	20	56.05M.69.5 KP.WP.MH O	F4 : Missing/painted/illegible label	10-18-2023	Punch Inspection	Missing	Contact ASSA ABLOY for field labeling	Non- Compliant	Non- Compliant
420-129	SNF	420	20	56.05M.69.5 KP.WP.MH O	OT : Mag Hold Open	10-18-2023	Punch Inspection	Missing wall plate	N/A	Non- Compliant	Non- Compliant
420-130	SNF	420	20	56.05M.69.5 KP.WP.MH O	D2 : Door damaged (bent, dented, delaminating)	10-18-2023	Punch Inspection	Split hinge	Replace	Non- Compliant	Non- Compliant
420-130	SNF	420	20	56.05M.69.5 KP.WP.MH O	D3 : Missing/painted/illegible label	10-18-2023	Punch Inspection	Label has been removed	N/A	Non- Compliant	Non- Compliant
420-130	SNF	420	20	56.05M.69.5 KP.WP.MH O	D9 : Improper field modification or repair	10-18-2023	Punch Inspection		N/A	Non- Compliant	Non- Compliant
420-130	SNF	420	20	56.05M.69.5 KP.WP.MH O	F4 : Missing/painted/illegible label	10-18-2023	Punch Inspection	Missing	Contact ASSA ABLOY for field labeling	Non- Compliant	Non- Compliant
420-132	SNF	420	20	56.04M.69.7	F4 : Missing/painted/illegible label	10-18-2023	Punch Inspection	Painted	Contact ASSA ABLOY for field labeling	Non- Compliant	Non- Compliant
420-133	SNF	420	20	56.38M.69.5 KP.WP	D9 : Improper field modification or repair	10-18-2023	Punch Inspection		Replace	Non- Compliant	Non- Compliant
420-133	SNF	420	20	56.38M.69.5 KP.WP	F4 : Missing/painted/illegible label	10-18-2023	Punch Inspection	Missing	Contact ASSA ABLOY for field labeling	Non- Compliant	Non- Compliant
420-134	SNF	420	20	56.38M/03C 69.7	D2 : Door damaged (bent, dented, delaminating)	10-18-2023	Punch Inspection		Replace	Non- Compliant	Non- Compliant
420-134	SNF	420	20	56.38M/03C 69.7	F4 : Missing/painted/illegible label	10-18-2023	Punch Inspection	Painted	Contact ASSA ABLOY for field labeling	Non- Compliant	Non- Compliant
420-135	SNF	420	20	55.95HL/03 69.5.KP.WP	D2 : Door damaged (bent, dented, delaminating)	10-18-2023	Punch Inspection		Replace	Non- Compliant	Non- Compliant
420-135	SNF	420	20	55.95HL/03 69.5.KP.WP	D9 : Improper field modification or repair	10-18-2023	Punch Inspection		Replace	Non- Compliant	Non- Compliant

420-135	SNF	420	20	55.95HL/03 69.5.KP.WP	F4 : Missing/painted/illegible label	10-18-2023	Punch Inspection	Painted	Contact ASSA ABLOY for field labeling	Non- Compliant	Non- Compliant
420-136	SNF	420	20	55.37M.69.5 KP.WP.MH O	D9 : Improper field modification or repair	10-18-2023	Punch Inspection		Replace	Non- Compliant	Non- Compliant
420-136	SNF	420	20	55.37M.69.5 KP.WP.MH O	F4 : Missing/painted/illegible label	10-18-2023	Punch Inspection	Missing	Contact ASSA ABLOY for field labeling	Non- Compliant	Non- Compliant
420-137	SNF	420	20	56.04M.69.7 WP	D9 : Improper field modification or repair	10-18-2023	Punch Inspection		Replace	Non- Compliant	Non- Compliant
420-137	SNF	420	20	56.04M.69.7 WP	F4 : Missing/painted/illegible label	10-18-2023	Punch Inspection	Painted	Contact ASSA ABLOY for field labeling	Non- Compliant	Non- Compliant
420-139	SNF	420	20	56.04M.69.7 KP.WP	D2 : Door damaged (bent, dented, delaminating)	10-18-2023	Punch Inspection		Replace	Non- Compliant	Non- Compliant
420-139	SNF	420	20	56.04M.69.7 KP.WP	D9 : Improper field modification or repair	10-18-2023	Punch Inspection		Replace	Non- Compliant	Non- Compliant
420-139	SNF	420	20	56.04M.69.7 KP.WP	F4 : Missing/painted/illegible label	10-18-2023	Punch Inspection	Missing	Contact ASSA ABLOY for field labeling	Non- Compliant	Non- Compliant
420-140	SNF	420	20	55.37M.69.7 WP	D9 : Improper field modification or repair	10-18-2023	Punch Inspection		Replace	Non- Compliant	Non- Compliant
420-140	SNF	420	20	55.37M.69.7 WP	F4 : Missing/painted/illegible label	10-18-2023	Punch Inspection	Painted	Contact ASSA ABLOY for field labeling	Non- Compliant	Non- Compliant
420-141	SNF	420	20	56.04M.69.7 KP.WP	D9 : Improper field modification or repair	10-18-2023	Punch Inspection		Replace	Non- Compliant	Non- Compliant
420-141	SNF	420	20	56.04M.69.7 KP.WP	F4 : Missing/painted/illegible label	10-18-2023	Punch Inspection	Painted	Contact ASSA ABLOY for field labeling	Non- Compliant	Non- Compliant
420-142	SNF	420	20	56.04M/04C 69.7.MHO	D2 : Door damaged (bent, dented, delaminating)	10-18-2023	Punch Inspection	Split door	Replace	Non- Compliant	Non- Compliant
420-143	SNF	420	20	56.38M/03C 69.7.KP	D2 : Door damaged (bent, dented, delaminating)	10-18-2023	Punch Inspection	Door split	Replace	Non- Compliant	Non- Compliant
420-143	SNF	420	20	56.38M/03C 69.7.KP	F4 : Missing/painted/illegible label	10-18-2023	Punch Inspection	Painted	Contact ASSA ABLOY for field labeling	Non- Compliant	Non- Compliant
420-145	SNF	420	20	56.04M.69.7 WP	D9 : Improper field modification or repair	10-18-2023	Punch Inspection		Replace	Non- Compliant	Non- Compliant
420-146	SNF	420	20	56.04M.69.4 (4").WP	D9 : Improper field modification or repair	10-18-2023	Punch Inspection		Replace	Non- Compliant	Non- Compliant
420-146	SNF	420	20	56.04M.69.4 (4").WP	F4 : Missing/painted/illegible label	10-18-2023	Punch Inspection	Missing	Contact ASSA ABLOY for field labeling	Non- Compliant	Non- Compliant
420-147	SNF	420	20	56.04M.69.4 (4")(2)	D9 : Improper field modification or repair	10-18-2023	Punch Inspection		Replace	Non- Compliant	Non- Compliant
420-147	SNF	420	20	56.04M.69.4 (4")(2)	F4 : Missing/painted/illegible label	10-18-2023	Punch Inspection	Missing	Contact ASSA ABLOY for field labeling	Non- Compliant	Non- Compliant
420-148	SNF	420	20	56.04M.41.4 (4").AF.KP. AS	D2 : Door damaged (bent, dented, delaminating)	10-18-2023	Punch Inspection	Both doors	Replace	Non- Compliant	Non- Compliant
420-148	SNF	420	20	56.04M.41.4 (4").AF.KP. AS	F4 : Missing/painted/illegible label	10-18-2023	Punch Inspection	Painted	Contact ASSA ABLOY for field labeling	Non- Compliant	Non- Compliant

420-149	SNF	420	None	55.95HL/03 50.7.WP	D2 : Door damaged (bent, dented, delaminating)	10-18-2023	Punch Inspection		Repair	Non-Compliant	Non-Compliant
420-150	SNF	420	20	56.05M.69.5 KP.WP.MH O	D2 : Door damaged (bent, dented, delaminating)	10-18-2023	Punch Inspection		Replace	Non-Compliant	Non-Compliant
420-150	SNF	420	20	56.05M.69.5 KP.WP.MH O	D3 : Missing/painted/illegible label	10-18-2023	Punch Inspection	Missing	N/A	Non-Compliant	Non-Compliant
420-150	SNF	420	20	56.05M.69.5 KP.WP.MH O	D9 : Improper field modification or repair	10-18-2023	Punch Inspection		N/A	Non-Compliant	Non-Compliant
420-150	SNF	420	20	56.05M.69.5 KP.WP.MH O	F4 : Missing/painted/illegible label	10-18-2023	Punch Inspection	Missing	Contact ASSA ABLOY for field labeling	Non-Compliant	Non-Compliant
420-150	SNF	420	20	56.05M.69.5 KP.WP.MH O	OT : Mag Hold Open	10-18-2023	Punch Inspection	Wall plate missing	N/A	Non-Compliant	Non-Compliant
420-151	SNF	420	20	56.04M.69.5 WP.MHO	D2 : Door damaged (bent, dented, delaminating)	10-18-2023	Punch Inspection		Replace	Non-Compliant	Non-Compliant
420-151	SNF	420	20	56.04M.69.5 WP.MHO	D3 : Missing/painted/illegible label	10-18-2023	Punch Inspection	Missing	N/A	Non-Compliant	Non-Compliant
420-151	SNF	420	20	56.04M.69.5 WP.MHO	D9 : Improper field modification or repair	10-18-2023	Punch Inspection		N/A	Non-Compliant	Non-Compliant
420-151	SNF	420	20	56.04M.69.5 WP.MHO	F4 : Missing/painted/illegible label	10-18-2023	Punch Inspection	Missing	Contact ASSA ABLOY for field labeling	Non-Compliant	Non-Compliant
420-152	SNF	420	20	56.05M.69.5 KP.WP.MH O	D2 : Door damaged (bent, dented, delaminating)	10-18-2023	Punch Inspection		Replace	Non-Compliant	Non-Compliant
420-152	SNF	420	20	56.05M.69.5 KP.WP.MH O	D9 : Improper field modification or repair	10-18-2023	Punch Inspection		N/A	Non-Compliant	Non-Compliant
420-153	SNF	420	20	56.05M.69.5 KP.WP.MH O	D2 : Door damaged (bent, dented, delaminating)	10-18-2023	Punch Inspection		Replace	Non-Compliant	Non-Compliant
420-153	SNF	420	20	56.05M.69.5 KP.WP.MH O	D3 : Missing/painted/illegible label	10-18-2023	Punch Inspection	Label has been removed	N/A	Non-Compliant	Non-Compliant
420-153	SNF	420	20	56.05M.69.5 KP.WP.MH O	D9 : Improper field modification or repair	10-18-2023	Punch Inspection		N/A	Non-Compliant	Non-Compliant
420-153	SNF	420	20	56.05M.69.5 KP.WP.MH O	F4 : Missing/painted/illegible label	10-18-2023	Punch Inspection	Missing	Contact ASSA ABLOY for field labeling	Non-Compliant	Non-Compliant
420-154	SNF	420	20	56.05M.69.5 KP.WP.MH O	D2 : Door damaged (bent, dented, delaminating)	10-18-2023	Punch Inspection		Replace	Non-Compliant	Non-Compliant
420-154	SNF	420	20	56.05M.69.5 KP.WP.MH O	D9 : Improper field modification or repair	10-18-2023	Punch Inspection		N/A	Non-Compliant	Non-Compliant
420-154	SNF	420	20	56.05M.69.5 KP.WP.MH O	F4 : Missing/painted/illegible label	10-18-2023	Punch Inspection	Missing	Contact ASSA ABLOY for field labeling	Non-Compliant	Non-Compliant
420-156	SNF	420	20	56.04M.69.7 WP	D2 : Door damaged (bent, dented, delaminating)	10-18-2023	Punch Inspection		Replace	Non-Compliant	Non-Compliant

420-156	SNF	420	20	56.04M.69.7 WP	D3 : Missing/painted/illegible label	10-18-2023	Punch Inspection	Missing	N/A	Non- Compliant	Non- Compliant
420-156	SNF	420	20	56.04M.69.7 WP	D9 : Improper field modification or repair	10-18-2023	Punch Inspection		N/A	Non- Compliant	Non- Compliant
420-156	SNF	420	20	56.04M.69.7 WP	F4 : Missing/painted/illegible label	10-18-2023	Punch Inspection	Missing	Contact ASSA ABLOY for field labeling	Non- Compliant	Non- Compliant
420-158	SNF	420	20	56.04M.69.4 (4")(3)	D2 : Door damaged (bent, dented, delaminating)	10-18-2023	Punch Inspection	Door split	Replace	Non- Compliant	Non- Compliant
420-162	SNF	420	20	56.04M.69.4 (4")(6)	F4 : Missing/painted/illegible label	10-18-2023	Punch Inspection	Painted	Contact ASSA ABLOY for field labeling	Non- Compliant	Non- Compliant
420-C100	SNF	420	20	45.10.69.5 T.SV.KP.E G.MHO	D3 : Missing/painted/illegible label	10-18-2023	Punch Inspection	1 door missing label	Contact ASSA ABLOY for field labeling	Non- Compliant	Non- Compliant
420-C100	SNF	420	20	45.10.69.5 T.SV.KP.E G.MHO	F4 : Missing/painted/illegible label	10-18-2023	Punch Inspection	Missing	Contact ASSA ABLOY for field labeling	Non- Compliant	Non- Compliant
420-C100	SNF	420	20	45.10.69.5 T.SV.KP.E G.MHO	O5 : Door drags on floor, rubs frame/rubs other door	10-18-2023	Punch Inspection	1 door rubs frame	N/A	Non- Compliant	Non- Compliant
A-101	SNF	A		26.38M.69.1	D9 : Improper field modification or repair	10-19-2023	Punch Inspection		Replace	Non- Compliant	Non- Compliant
A-102	SNF	A	None	56.04M/030 69.7.KP	O5 : Door drags on floor, rubs frame/rubs other door	10-17-2023	Punch Inspection	Rubs on frame	N/A	Non- Compliant	Non- Compliant
A-103	SNF	A	20	56.04M.69.5 KP.WP	D9 : Improper field modification or repair	10-17-2023	Punch Inspection		Replace	Non- Compliant	Non- Compliant
A-103	SNF	A	20	56.04M.69.5 KP.WP	F4 : Missing/painted/illegible label	10-17-2023	Punch Inspection	Missing	Contact ASSA ABLOY for field labeling	Non- Compliant	Non- Compliant
A-104	SNF	A		56.04M.50.4 (4x4).	D2 : Door damaged (bent, dented, delaminating)	10-17-2023	Punch Inspection		Replace	Non- Compliant	Non- Compliant
A-114	SNF	A	20	56.04M.50.4 (4x4).	D2 : Door damaged (bent, dented, delaminating)	10-17-2023	Punch Inspection		Replace	Non- Compliant	Non- Compliant
A-114	SNF	A	20	56.04M.50.4 (4x4).	F4 : Missing/painted/illegible label	10-17-2023	Punch Inspection	Missing	Contact ASSA ABLOY for field labeling	Non- Compliant	Non- Compliant
A-116	SNF	A	20	56.04M.50.4 (4x4).	D2 : Door damaged (bent, dented, delaminating)	10-17-2023	Punch Inspection		Replace	Non- Compliant	Non- Compliant
A-116	SNF	A	20	56.04M.50.4 (4x4).	F4 : Missing/painted/illegible label	10-17-2023	Punch Inspection	Missing	Contact ASSA ABLOY for field labeling	Non- Compliant	Non- Compliant
A-118	SNF	A	20	56.04M/03.6 4.4(4x4).KP PP	D2 : Door damaged (bent, dented, delaminating)	10-17-2023	Punch Inspection		Replace	Non- Compliant	Non- Compliant
A-118	SNF	A	20	56.04M/03.6 4.4(4x4).KP PP	F4 : Missing/painted/illegible label	10-17-2023	Punch Inspection	Missing	Contact ASSA ABLOY for field labeling	Non- Compliant	Non- Compliant
A-119	SNF	A	20	56.04M.64.5	D2 : Door damaged (bent, dented, delaminating)	10-17-2023	Punch Inspection		Replace	Non- Compliant	Non- Compliant
A-119	SNF	A	20	56.04M.64.5	F4 : Missing/painted/illegible label	10-17-2023	Punch Inspection	Missing	Contact ASSA ABLOY for field labeling	Non- Compliant	Non- Compliant

A-120A	SNF	A			26.38M/99.0 0.1.S.MF.	PP1 : Missing/damaged/broken/ ninstalled incorrectly	10-17-2023	Punch Inspection		Replace	Non- Compliant	Non- Compliant
A-120B	SNF	A	20		56.38M.69.5 KP.AP	D2 : Door damaged (bent, dented, delaminating)	10-17-2023	Punch Inspection		Replace	Non- Compliant	Non- Compliant
A-122	SNF	A	20		56.04M.64.4 (4")	D2 : Door damaged (bent, dented, delaminating)	10-17-2023	Punch Inspection		Replace	Non- Compliant	Non- Compliant
A-122	SNF	A	20		56.04M.64.4 (4")	D3 : Missing/painted/illegible label	10-17-2023	Punch Inspection	Missing label	N/A	Non- Compliant	Non- Compliant
A-122	SNF	A	20		56.04M.64.4 (4")	D9 : Improper field modification or repair	10-17-2023	Punch Inspection		N/A	Non- Compliant	Non- Compliant
A-122	SNF	A	20		56.04M.64.4 (4")	F4 : Missing/painted/illegible label	10-17-2023	Punch Inspection	Missing label	Contact ASSA ABLOY for field labeling	Non- Compliant	Non- Compliant
A-123	SNF	A	20		56.04M.69.4 (4")	D2 : Door damaged (bent, dented, delaminating)	10-17-2023	Punch Inspection		Replace	Non- Compliant	Non- Compliant
A-123	SNF	A	20		56.04M.69.4 (4")	D3 : Missing/painted/illegible label	10-17-2023	Punch Inspection	Missing	N/A	Non- Compliant	Non- Compliant
A-123	SNF	A	20		56.04M.69.4 (4")	F4 : Missing/painted/illegible label	10-17-2023	Punch Inspection	Missing	Contact ASSA ABLOY for field labeling	Non- Compliant	Non- Compliant
A-124	SNF	A	20		56.04M.69.4 (4").KP	D2 : Door damaged (bent, dented, delaminating)	10-17-2023	Punch Inspection		Replace	Non- Compliant	Non- Compliant
A-124	SNF	A	20		56.04M.69.4 (4").KP	D3 : Missing/painted/illegible label	10-17-2023	Punch Inspection	Missing	N/A	Non- Compliant	Non- Compliant
A-124	SNF	A	20		56.04M.69.4 (4").KP	F4 : Missing/painted/illegible label	10-17-2023	Punch Inspection	Missing	Contact ASSA ABLOY for field labeling	Non- Compliant	Non- Compliant
A-136B	SNF	A	60		56.04M.69.7	D2 : Door damaged (bent, dented, delaminating)	10-17-2023	Punch Inspection		Replace	Non- Compliant	Non- Compliant
A-136B	SNF	A	60		56.04M.69.7	F4 : Missing/painted/illegible label	10-17-2023	Punch Inspection	Painted	Contact ASSA ABLOY for field labeling	Non- Compliant	Non- Compliant
A-136C	SNF	A	20		56.38M.69.5 KP.AP	D2 : Door damaged (bent, dented, delaminating)	10-17-2023	Punch Inspection		Replace	Non- Compliant	Non- Compliant
A-136C	SNF	A	20		56.38M.69.5 KP.AP	F4 : Missing/painted/illegible label	10-17-2023	Punch Inspection	Missing	Contact ASSA ABLOY for field labeling	Non- Compliant	Non- Compliant
A-142A	SNF	A			26.04M.00.5 MF.KP.	D2 : Door damaged (bent, dented, delaminating)	10-17-2023	Punch Inspection		Replace	Non- Compliant	Non- Compliant
A-142B	SNF	A	20		56.04M.61.5	D1 : Rust-through on door	10-17-2023	Punch Inspection		Replace	Non- Compliant	Non- Compliant
A-142B	SNF	A	20		56.04M.61.5	D3 : Missing/painted/illegible label	10-17-2023	Punch Inspection	Missing	N/A	Non- Compliant	Non- Compliant
A-142B	SNF	A	20		56.04M.61.5	F2 : Damaged/rust through on frame	10-17-2023	Punch Inspection		Replace	Non- Compliant	Non- Compliant
A-142B	SNF	A	20		56.04M.61.5	F4 : Missing/painted/illegible label	10-17-2023	Punch Inspection	Missing	N/A	Non- Compliant	Non- Compliant

A-143A	SNF	A	20	56.38M.69.5 KP.	D2 : Door damaged (bent, dented, delaminating)	10-17-2023	Punch Inspection		Replace	Non- Compliant	Non- Compliant
A-143A	SNF	A	20	56.38M.69.5 KP.	F4 : Missing/painted/illegible label	10-17-2023	Punch Inspection	Missing	Contact ASSA ABLOY for field labeling	Non- Compliant	Non- Compliant
A-143B	SNF	A	20	56.38M.69.5 KP.	D2 : Door damaged (bent, dented, delaminating)	10-17-2023	Punch Inspection		Replace	Non- Compliant	Non- Compliant
A-143B	SNF	A	20	56.38M.69.5 KP.	F4 : Missing/painted/illegible label	10-17-2023	Punch Inspection	Missing	Contact ASSA ABLOY for field labeling	Non- Compliant	Non- Compliant
A-146	SNF	A		56.04M.69.4 (4")	O5 : Door drags on floor, rubs frame/rubs other door	10-17-2023	Punch Inspection	Door rubs on floor and frame	N/A	Non- Compliant	Non- Compliant
A-147A	SNF	A	20	56.38M.69.5 AP.PP	D2 : Door damaged (bent, dented, delaminating)	10-17-2023	Punch Inspection		Replace	Non- Compliant	Non- Compliant
A-147A	SNF	A	20	56.38M.69.5 AP.PP	F4 : Missing/painted/illegible label	10-17-2023	Punch Inspection	Missing	Contact ASSA ABLOY for field labeling	Non- Compliant	Non- Compliant
A-147A	SNF	A	20	56.38M.69.5 AP.PP	O5 : Door drags on floor, rubs frame/rubs other door	10-17-2023	Punch Inspection	Rubs on floor	N/A	Non- Compliant	Non- Compliant
A-147B	SNF	A	20	56.38M.69.5 AP.PP	D2 : Door damaged (bent, dented, delaminating)	10-17-2023	Punch Inspection		Replace	Non- Compliant	Non- Compliant
A-147B	SNF	A	20	56.38M.69.5 AP.PP	F4 : Missing/painted/illegible label	10-17-2023	Punch Inspection	Missing	Contact ASSA ABLOY for field labeling	Non- Compliant	Non- Compliant
A-148A	SNF	A	20	56.38M.69.5 KP.	D2 : Door damaged (bent, dented, delaminating)	10-17-2023	Punch Inspection		Replace	Non- Compliant	Non- Compliant
A-148A	SNF	A	20	56.38M.69.5 KP.	F4 : Missing/painted/illegible label	10-17-2023	Punch Inspection	Missing	Contact ASSA ABLOY for field labeling	Non- Compliant	Non- Compliant
A-148B	SNF	A	20	56.38M.69.5 KP.	D2 : Door damaged (bent, dented, delaminating)	10-17-2023	Punch Inspection		Replace	Non- Compliant	Non- Compliant
A-148B	SNF	A	20	56.38M.69.5 KP.	F4 : Missing/painted/illegible label	10-17-2023	Punch Inspection	Missing	Contact ASSA ABLOY for field labeling	Non- Compliant	Non- Compliant
A-149	SNF	A	20	55.04KPL.5 0.5	D3 : Missing/painted/illegible label	10-17-2023	Punch Inspection	Label missing	Contact ASSA ABLOY for field labeling	Non- Compliant	Non- Compliant
A-149	SNF	A	20	55.04KPL.5 0.5	D4 : Incorrect/missing/broken glass	10-17-2023	Punch Inspection	Non-rated glazing	Replace	Non- Compliant	Non- Compliant
A-149	SNF	A	20	55.04KPL.5 0.5	F4 : Missing/painted/illegible label	10-17-2023	Punch Inspection	Missing label	Contact ASSA ABLOY for field labeling	Non- Compliant	Non- Compliant
A-150	SNF	A		56.04M.69.4 (4")	D2 : Door damaged (bent, dented, delaminating)	10-17-2023	Punch Inspection		Repair	Non- Compliant	Non- Compliant
A-151	SNF	A	20	56.04M.50.4 (4x4).	O5 : Door drags on floor, rubs frame/rubs other door	10-17-2023	Punch Inspection	Rubs on frame	N/A	Non- Compliant	Non- Compliant
A-159	SNF	A	20	56.04M.69.4 (4")	D2 : Door damaged (bent, dented, delaminating)	10-17-2023	Punch Inspection		Replace	Non- Compliant	Non- Compliant

A-159	SNF	A	20	56.04M.69.4 (4")	D2 : Door damaged (bent, dented, delaminating)	10-17-2023	Punch Inspection	Damages	Replace	Non-Compliant	Non-Compliant
A-159	SNF	A	20	56.04M.69.4 (4")	D3 : Missing/painted/illegible label	10-17-2023	Punch Inspection	Missing label	N/A	Non-Compliant	Non-Compliant
A-159	SNF	A	20	56.04M.69.4 (4")	F4 : Missing/painted/illegible label	10-17-2023	Punch Inspection	Label missing	Contact ASSA ABLOY for field labeling	Non-Compliant	Non-Compliant
A-160	SNF	A	20	56.04M.50.4 (4x4).	D2 : Door damaged (bent, dented, delaminating)	10-17-2023	Punch Inspection		Replace	Non-Compliant	Non-Compliant
A-160	SNF	A	20	56.04M.50.4 (4x4).	D3 : Missing/painted/illegible label	10-17-2023	Punch Inspection	Missing	N/A	Non-Compliant	Non-Compliant
A-160	SNF	A	20	56.04M.50.4 (4x4).	F4 : Missing/painted/illegible label	10-17-2023	Punch Inspection	Missing	Contact ASSA ABLOY for field labeling	Non-Compliant	Non-Compliant
A-161	SNF	A	20	56.04M.50.4 (4x4).	D2 : Door damaged (bent, dented, delaminating)	10-17-2023	Punch Inspection		Replace	Non-Compliant	Non-Compliant
A-161	SNF	A	20	56.04M.50.4 (4x4).	D3 : Missing/painted/illegible label	10-17-2023	Punch Inspection	missing	N/A	Non-Compliant	Non-Compliant
A-161	SNF	A	20	56.04M.50.4 (4x4).	F4 : Missing/painted/illegible label	10-17-2023	Punch Inspection	Missing	Contact ASSA ABLOY for field labeling	Non-Compliant	Non-Compliant
A-418	SNF	A		56.38M.69.1 EG	O2 : Door does not close completely	10-17-2023	Punch Inspection	Hits the frame	N/A	Non-Compliant	Non-Compliant
A-419	SNF	A		56.38M.69.1 EG	O2 : Door does not close completely	10-17-2023	Punch Inspection	Hits frame	N/A	Non-Compliant	Non-Compliant
A-420	SNF	A	None	56.38M.69.1 EG	LO1 : Lock missing/damaged/not securely fastened	10-17-2023	Punch Inspection	Missing faceplate	N/A	Non-Compliant	Non-Compliant
A-420	SNF	A	None	56.38M.69.1 EG	O5 : Door drags on floor, rubs frame/rubs other door	10-17-2023	Punch Inspection	Rubs on frame	N/A	Non-Compliant	Non-Compliant

Additional Detailed Instructions

Project: DSH Metro SNF Bldg. Interior Repairs

ADI Number: 2.0

Date: 7/15/24

Contractor: Kazoni Construction

DGS Number: DGS00000142412C

- A. The scope of work includes all interior lined ductwork in the skilled nursing facility (SNF) building at the Department of state Hospital, metropolitan (DSH-M) including buildings 417, 418, 419, and 420. The work requires cutting access openings to inspect and repair the interior ductwork lining. All-access openings must be patched and sealed after work is completed.

- B. Assessment Procedure
 1. Survey and inspect all ductwork where lining exists. Inspect all ductwork from the outlet of the air handling unit (AHU) to the location in the corridor where the duct lining terminates. Assume the interior duct lining terminates in the corridor before entering the spaces adjacent to the corridor. Provide video documentation of the interior of the duct.
 2. The contractor shall provide video documentation and recommendations with "Replace" or "Encapsulate" options described below in the Repair Options section. The government shall review and approve recommendations provided by the contractor.

- C. Repair Options
 1. Replace: Replace duct lining in locations where the ductwork lining is dilapidated or damaged beyond repair. Submit ductwork lining materials for approval by the government. Johns Manville Linacoustic R-300, Knauf Performance Plus, or equivalent is acceptable.
 2. Encapsulate: Patch and repair ductwork lining where minor to moderate damage exists. Patch ductwork lining and re-pin as necessary. Encapsulate with sealant formulated to coat and repair ductwork lining. Submit product

for government approval. Acceptable sealants are Carlisle RE-300, Fiberlock IAQ-8000, or equivalent. Completely seal all duct lining, including edges. Install sealant per manufacturer recommendations.

3. Patch and seal all openings cut to access the interior of the ductwork.

Issued by: Byron Spears, P.E.

Senior Mechanical Engineer

Additional Detailed Instructions

Project: DSH Metro SNF Bldg. Interior Repairs

ADI Number: 03.0

Date: 08/22/24

Contractor: Amoroso Construction

DGS Number: DGS00000142412CE

Directive:

After reviewing the project's as-built drawings and reviewing site photos, we are directing the contractor to use the attached recommended product assembly.

Action:

Please incorporate the attached product assembly details into your work.

Attachments:

Product information sheet.

Issued by:

MJ Kang

Ramy Eskander

801 Series

A07 - Wall to Wall or Ceiling to Ceiling

A09 - Wall to Corner or Wall to Ceiling

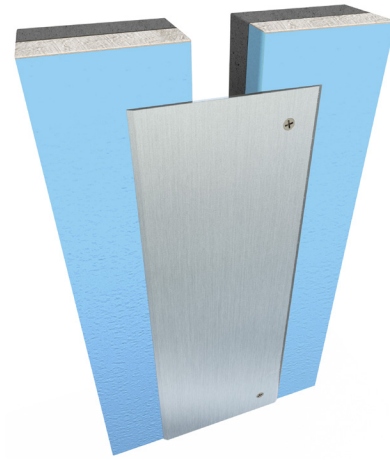

Movement Rating \pm 50%

Product Guide



Thermal



Exterior



Interior



Fire Rated Option



Vapor Barrier Option

- Designed with beveled edges
- Easy to install
- Economical solution for retrofit and surface mount installations
- Clear Anodized finish standard
- Available in **stainless steel** and brass
- Wide variety of widths and hole configurations available
- Optional finish available: Brushed, Anodized, Kynar, powder and primed for field painting

Application	System	W		H		S		Movement +/-			
		Joint Width		Frame Height		Sightline		Horizontal		Vertical	
		US	mm	US	mm	US	mm	US	mm	US	mm
Wall to Wall	801-A07-025	1"	25	1/8"	3	4 1/8"	105	1/2"	13	*	*
	801-A07-050	2"	51	1/8"	3	5 5/8"	143	1"	25	*	*
	801-A07-075	3"	76	1/4"	6	9 1/4"	235	1 1/2"	38	*	*
	801-A07-100	4"	102	1/4"	6	9 1/4"	235	2"	51	*	*
Wall to Corner	801-A09-025	1"	25	1/8"	3	2 9/16"	65	1/2"	13	*	*
	801-A09-050	2"	51	1/8"	3	3 15/16"	97	1"	25	*	*
	801-A09-075	3"	76	1/4"	6	7 7/16"	189	1 1/2"	38	*	*
	801-A09-100	4"	102	1/4"	6	7 7/16"	189	2"	51	*	*

IPC.1580/REV.6

801 Series

Wall and Ceiling Systems

801-A07 Wall/Wall
(2" (50mm) system shown)

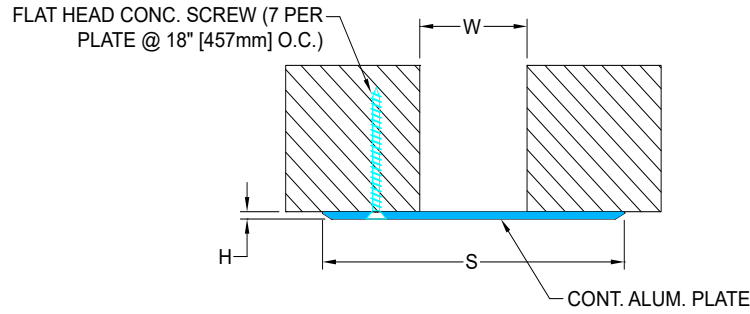

801-A09 Ceiling/ Wall
(2" (50mm) system shown)

WALL TO CORNER

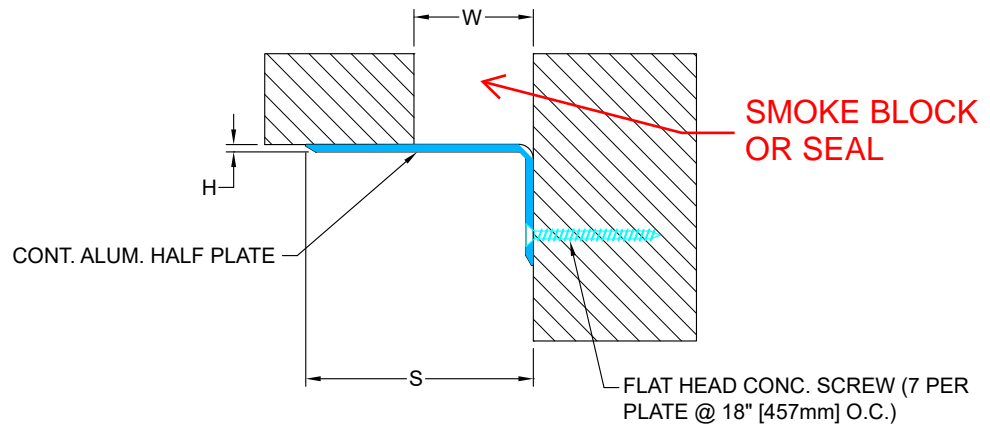

801 Series Options

801-A07 with Mineral Wool & Gun Grade Sealant
Fire Barrier System
(2" (50mm) system shown)

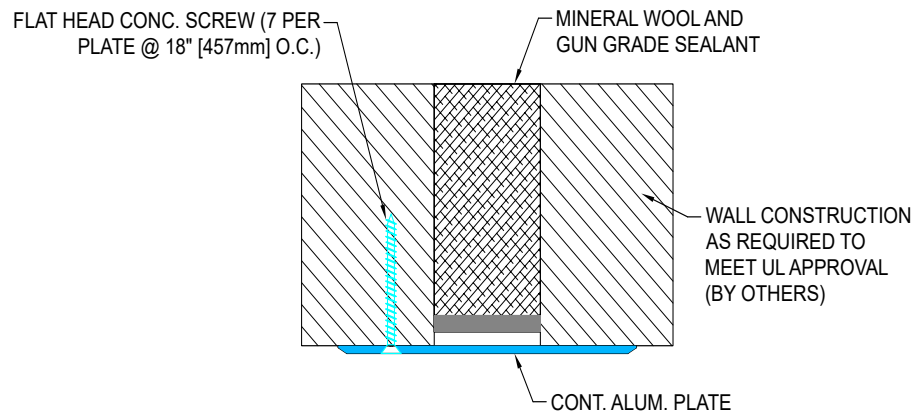

801-A07 with Vapor Barrier
(2" (50mm) system shown)

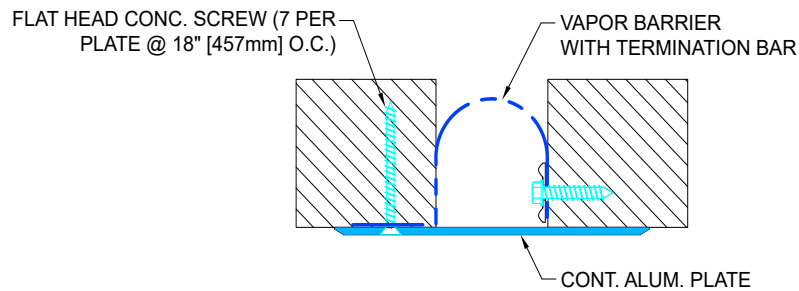

SECTION 083113

ACCESS DOORS AND FRAMES

PART 1 - GENERAL

1.1 SUMMARY

A. Section Includes:

1. Fire-rated access doors and frames.

1.2 ALLOWANCES

- ###### A. Access doors and frames are part of an access door and frame allowance.

1.3 ACTION SUBMITTALS

A. Product Data: For each type of product.

1. Include construction details fire ratings, material descriptions, dimensions of individual components and profiles, and finishes.

- ###### B. Samples: For each type of access door and frame and for each finish specified, complete assembly minimum 6 by 6 inches (150 by 150 mm) in size.

- ###### C. Product Schedule: For access doors and frames. Provide reference reflected ceiling plan.

1.4 INFORMATIONAL SUBMITTALS

A. Qualification Data: For testing and inspecting agency.

1. Fire-Rated Door Inspector: Submit documentation of compliance with NFPA 80, Section 5.2.3.1.
2. Submit copy of DHI Fire and Egress Door Assembly Inspector (FDAI) certificate.

1.5 CLOSEOUT SUBMITTALS

- ###### A. Record Documents: For fire-rated doors, list of applicable room name and number in which access door is located.

1.6 QUALITY ASSURANCE

- A. Fire-Rated Door Inspector Qualifications: Inspector for field quality control inspections of fire-rated door assemblies meets the qualifications set forth in NFPA 80, Section 5.2.3.1 and the following:
 - 1. Door and Hardware Institute Fire and Egress Door Assembly Inspector (FDAI) certification.

PART 2 - PRODUCTS

2.1 PERFORMANCE REQUIREMENTS

- A. Fire-Rated Access Doors and Frames: Assemblies complying with NFPA 80 that are listed and labeled by a qualified testing agency, for fire-protection ratings indicated, according to NFPA 252 or UL 10B.

2.2 FIRE-RATED ACCESS DOORS AND FRAMES

- A. Fire-Rated, Flush Access Doors with Exposed Flanges:
 - 1. Basis-of-Design Product: Subject to compliance with requirements, provide Nystrom, Inc.; IT or a comparable product by one of the following:
 - a. Babcock-Davis.
 - b. Best Access Doors
 - c. Acudor
 - d. Cendrex Inc.
 - 2. Description: Door face flush with frame, with a core of mineral-fiber insulation enclosed in sheet metal with exposed flange, self-closing door, and concealed hinge.
 - 3. Optional Features: Piano hinges.
 - 4. Locations: Ceiling.
 - 5. Door Size: same as existing.
 - 6. Fire-Resistance Rating: Not less than 1 hour.
 - 7. Uncoated Steel Sheet for Door: Nominal 0.036 inch (0.91 mm), 20 gage, factory primed or finished with the color selected by Architect and Facility manager.
 - 8. Stainless Steel Sheet for Door: Nominal 0.038 inch (0.95 mm), 20 gage ASTM A480/A480M No. 4 finish.
 - 9. Frame Material: Same material and finish as door, Nominal 0.062 inch (1.6 mm), 16 gauge.
 - 10. Latch and Lock: Self-latching door hardware, prepared for mortise cylinder with interior release.
- B. Fire-Rated, Flush Access Doors with Concealed Flanges:

1. Basis-of Design Product: Subject to compliance with requirements, provide Nystrom, Inc.; IW, drywall flange, IP, plaster flange or comparable product by one of the following:
 - a. Acudor
 - b. Best Access Doors
 - c. Babcockdavis
 - d. Cendrex
2. Description: Door face flush with frame, with a core of mineral-fiber insulation enclosed in sheet metal with concealed flange for gypsum board and plaster installation, self-closing door, and concealed hinge.
3. Optional Features: Piano hinges.
4. Locations: Ceiling.
5. Door Size: Match existing door size.
6. Fire-Resistance Rating: Not less than 1 hour.
7. Uncoated Steel Sheet for Door: Nominal 0.036 inch (0.91 mm), 20 gage, factory primed or finished with the color selected by Architect and Facility manager.
8. Stainless Steel Sheet for Door: Nominal 0.038 inch (0.95 mm), 20 gage ASTM A480/A480M No. 4 finish.
9. Frame Material: Same material and finish as door, Nominal 0.062 inch (1.6 mm), 16 gauge.
10. Latch and Lock: Self-closing, self-latching door hardware, prepared for mortise cylinder with interior release.

2.3 MATERIALS

- A. Steel Plates, Shapes, and Bars: ASTM A36/A36M.
- B. Steel Sheet: Uncoated or electrolytic zinc coated, ASTM A879/A879M, with cold-rolled steel sheet substrate complying with ASTM A1008/A1008M, Commercial Steel (CS), exposed.
- C. Metallic-Coated Steel Sheet: ASTM A653/A653M, Commercial Steel (CS), Type B; with minimum G60 (Z180) or A60 (ZF180) metallic coating.
- D. Stainless Steel Plate, Sheet, and Strip: ASTM A240/A240M or ASTM A666, Type 316. Remove tool and die marks and stretch lines, or blend into finish.
- E. Stainless Steel Flat Bars: ASTM A666, Type 316. Remove tool and die marks and stretch lines, or blend into finish.
- F. Aluminum Extrusions: ASTM B221 (ASTM B221M), Alloy 6063.
- G. Aluminum Sheet: ASTM B209 (ASTM B209M), alloy and temper recommended by aluminum producer and finisher for type of use and finish indicated.
- H. Frame Anchors: Same material as door face.

- I. Inserts, Bolts, and Anchor Fasteners: Hot-dip galvanized steel according to ASTM A153/A153M or ASTM F2329.

2.4 FABRICATION

- A. General: Provide access door and frame assemblies manufactured as integral units ready for installation.
- B. Metal Surfaces: For metal surfaces exposed to view in the completed Work, provide materials with smooth, flat surfaces without blemishes. Do not use materials with exposed pitting, seam marks, roller marks, rolled trade names, or roughness.
- C. Doors and Frames: Grind exposed welds smooth and flush with adjacent surfaces. Furnish mounting holes, attachment devices and fasteners of type required to secure access doors to types of supports indicated.
 1. For concealed flanges with drywall bead, provide edge trim for gypsum panels securely attached to perimeter of frames.
 2. For concealed flanges with plaster bead for full-bed plaster applications, provide zinc-coated expanded-metal lath and exposed casing bead welded to perimeter of frames.
- D. Recessed Access Doors: Form face of panel to provide recess for application of applied finish. Reinforce panel as required to prevent buckling. Provide access sleeves for each latch operator and install in holes cut through finish.
 1. For recessed doors with plaster infill, provide self-furring expanded-metal lath attached to door panel.
- E. Latch and Lock Hardware:
 1. Quantity: Furnish number of latches and locks required to hold doors tightly closed.
 2. Keys: Furnish two keys per lock and key all locks alike.
 3. Mortise Cylinder: Prepare door panel to accept cylinder. Provide mortise cylinder lock to comply with testing and minimum ½” latch throw.

2.5 FINISHES

- A. Comply with NAAMM's "Metal Finishes Manual for Architectural and Metal Products" for recommendations for applying and designating finishes.
- B. Protect mechanical finishes on exposed surfaces from damage by applying a strippable, temporary protective covering before shipping.
- C. Appearance of Finished Work: Noticeable variations in same piece are not acceptable. Variations in appearance of adjoining components are acceptable if they are within the range of approved Samples and are assembled or installed to minimize contrast.

- D. Painted Finishes: Comply with coating manufacturer's written instructions for cleaning, conversion coating, and applying and baking finish.
 - 1. Factory Primed: Apply manufacturer's standard, lead- and chromate-free, universal primer immediately after surface preparation and pretreatment.
 - 2. Factory Finished: Apply manufacturer's standard baked-enamel or powder-coat finish immediately after cleaning and pretreating, with minimum dry-film thickness of 1 mil (0.025 mm) for topcoat.
 - a. Color: As selected by Architect and facility from full range of industry colors
- E. Stainless Steel Finishes:
 - 1. Surface Preparation: Remove tool and die marks and stretch lines, or blend into finish.
 - 2. Polished Finish: ASTM A480/A480M No. 4 finish. Grind and polish surfaces to produce uniform finish, free of cross scratches.
 - a. Run grain of directional finishes with long dimension of each piece.
 - b. When polishing is completed, passivate and rinse surfaces. Remove embedded foreign matter and leave surfaces chemically clean.

PART 3 - EXECUTION

3.1 EXAMINATION

- A. Examine substrates for compliance with requirements for installation tolerances and other conditions affecting performance of the Work.
- B. Proceed with installation only after unsatisfactory conditions have been corrected.

3.2 INSTALLATION

- A. Comply with manufacturer's written instructions for installing access doors and frames.

3.3 FIELD QUALITY CONTROL

- A. Inspection Agency: Engage a qualified inspector to perform inspections and to furnish reports to Architect.
- B. Inspections:
 - 1. Fire-Rated Door Inspections: Inspect each fire-rated access door in accordance with NFPA 80, Section 5.2.
- C. Repair or remove and replace installations where inspections indicate that they do not comply with specified requirements.

- D. Reinspect repaired or replaced installations to determine if replaced or repaired door assembly installations comply with specified requirements.
- E. Prepare and submit separate inspection report for each fire-rated access door indicating compliance with each item listed in NFPA 80 and NFPA 101.

3.4 ADJUSTING

- A. Adjust doors and hardware, after installation, for proper operation.

END OF SECTION 083113

SECTION 123216

MANUFACTURED PLASTIC-LAMINATE-CLAD CASEWORK

PART 1 - GENERAL

1.1 SUMMARY

A. Section Includes:

1. Plastic-laminate-clad casework.
2. Hardware and accessories.

B. Related Requirements:

1. Section 092216 "Non-Structural Metal Framing" for reinforcements in metal-framed partitions for anchoring casework.
2. Section 096513 "Resilient Base and Accessories" for resilient base applied to plastic-laminate-clad casework.
3. Section 123553.16 "Plastic-Laminate Laboratory Casework."
4. Section 123623.13 "Plastic-Laminate-Clad Countertops."

1.2 DEFINITIONS

- A. Definitions in the AWI/AWMAC/WI's "Architectural Woodwork Standards" apply to the Work of this Section.

1.3 PREINSTALLATION MEETINGS

- A. Keying Conference: Conduct conference at [Project site] <Insert location>. Incorporate keying conference decisions into final keying requirements.

1.4 COORDINATION

- A. Coordinate sizes and locations of framing, blocking, furring, reinforcements, and other related units of Work specified in other Sections to ensure that casework can be supported and installed as indicated.
- B. Coordinate with Facility Manager and Project Manager for locations and types of key requirements.

1.5 ACTION SUBMITTALS

- A. Product Data: For each type of product.
- B. Shop Drawings: For plastic-laminate-clad casework.
 - 1. Include plans, elevations, sections, and attachments to other work including blocking and reinforcements required for installation.
 - 2. Indicate types and sizes of casework.
 - 3. Indicate manufacturer's catalog numbers for casework.
 - 4. Show fabrication details, including types and locations of hardware.
 - 5. Indicate locations of and clearances from adjacent walls, doors, windows, other building components, and equipment.
 - 6. Apply WI's Certified Compliance Program label to Shop Drawings.
- C. Keying Schedule: Include schematic keying diagram, and index each key set to unique designations that are coordinated with the Contract Documents.
- D. Samples: For casework and hardware finishes.
- E. Samples for Initial Selection: For casework and hardware finishes.
- F. Samples for Verification: For the following:
 - 1. Plastic Laminates: 12 by 12 inches (300 by 300 mm), for each type, color, pattern, and surface finish required.
 - a. Provide one Sample applied to core material with specified edge material applied to one edge.
 - b. Provide edge banding on one edge.

1.6 INFORMATIONAL SUBMITTALS

- A. Qualification Data: For casework manufacturer and Installer.
- B. Sample Warranty: For special warranty.
- C. Field quality-control reports.

1.7 CLOSEOUT SUBMITTALS

- A. Quality Standard Compliance Certificates: [AWI's Quality Certification Program] [WI's Certified Compliance Program certificates].

1.8 QUALITY ASSURANCE

- A. Installer Qualifications: Licensed participate in WI's Certified Compliance Program.

1.9 DELIVERY, STORAGE, AND HANDLING

- A. Protect finished surfaces during handling and installation with protective covering of polyethylene film or other suitable material.

1.10 FIELD CONDITIONS

- A. Environmental Limitations: Do not deliver or install casework until building is enclosed, wet-work is complete, and HVAC system is operating and maintaining temperature and relative humidity at levels planned for building occupants during remainder of construction period. Maintain temperature and relative humidity during remainder of construction period in range recommended for Project location by the AWI/AWMAC/WI's "Architectural Woodwork Standards."
- B. Established Dimensions: Where casework is indicated to fit to other construction, establish dimensions for areas where casework is to fit. Provide allowance for trimming at site, and coordinate construction to ensure that actual dimensions correspond to established dimensions.
- C. Field Measurements: Where casework is indicated to fit to existing construction, verify dimensions of existing construction by field measurements before fabrication and indicate measurements on Shop Drawings. Provide fillers and scribes to allow for trimming and fitting.
- D. Locate concealed framing, blocking, and reinforcements that support casework by field measurements before enclosing them, and indicate measurements on Shop Drawings.

1.11 WARRANTY

- A. Special Warranty: Manufacturer agrees to repair or replace components of casework that fail in materials or workmanship within specified warranty period.
 - 1. Failures include, but are not limited to, the following:
 - a. Delamination of components or other failures of glue bond.
 - b. Warping of components.
 - c. Failure of operating hardware.
 - 2. Warranty Period: Five years from date of Substantial Completion.

PART 2 - PRODUCTS

2.1 GENERAL REQUIREMENTS FOR CASEWORK

- A. Quality Standard: Unless otherwise indicated, comply with the AWI/AWMAC/WI's "Architectural Woodwork Standards" for grades of casework indicated for construction, finishes, installation, and other requirements.
1. Grade: Premium or Custom
 2. Provide labels and certificates from WI certification program indicating that casework complies with requirements of grades specified.

2.2 PLASTIC-LAMINATE-CLAD CASEWORK

A. Manufacturers

1. Kewaunee Scientific Corporation, Architectural Millwork, Laminate
2. Advanced Cabinet Systems
3. Onepoint Solutions
4. Stolo Cabinets, Inc

B. Source Limitations: Obtain from single source from single manufacturer.

C. Design: Face-frame and Frameless cabinet construction with the following door and drawer-front style:

1. Reveal overlay with recessed finger pulls machined into faces of doors and drawers.
2. Flush overlay.

D. Grain Direction for Wood-Grain Plastic Laminate:

1. Doors: Vertical with continuous vertical matching.
2. Drawer Fronts: Vertical with continuous vertical matching.
3. Face Frame Members: Lengthwise.
4. End Panels: Vertical.
5. Bottoms and Tops of Units: Side to side.
6. Knee Space Panels: Vertical.
7. Aprons: Horizontal.

E. Exposed Materials:

1. Plastic-Laminate Grade: HGS.
 - a. Colors and Patterns: Match Architect's finish schedule
2. Edgebanding: Plastic laminate matching adjacent surfaces

3. Solid Wood: Clear hardwood lumber of species indicated, selected for compatible grain and color.
 - a. Wood Species: Match existing cabinet.
 - b. Wood Finish: Match Architect's finish schedule.

F. Semiexposed Materials:

1. Plastic Laminate: Grade VGS unless otherwise indicated. Provide plastic laminate for semiexposed surfaces unless otherwise indicated.
 - a. Provide plastic laminate of same grade as exposed surfaces for interior faces of doors and drawer fronts and other locations where opposite side of component is exposed.
2. Hardboard: Use only for cabinet backs where exterior side of back is not exposed.
3. Metal for Steel Drawer Pans: Cold-rolled, carbon-steel sheet complying with ASTM A1008/A1008M; matte finish; suitable for exposed applications.
4. Unless otherwise indicated, provide specified edgebanding on all semiexposed edges.

G. Concealed Materials:

1. Solid Wood: With no defects affecting strength or utility.
2. Plywood: Hardwood plywood.
3. Plastic Laminate: Grade BKL.
4. Particleboard.
5. MDF.
6. Hardboard.

2.3 HARDWARE AND ACCESSORIES

- A. Hardware, General: Unless otherwise indicated, provide manufacturer's standard powder-coated, commercial-quality, heavy-duty hardware.
 1. Use threaded metal or plastic inserts with machine screws for fastening to particleboard except where hardware is through-bolted from back side.
- B. Butt Hinges: Stainless steel, semiconcealed, five-knuckle hinges complying with ANSI/BHMA A156.9, Grade 1, with antifriction bearings and rounded tips. Provide two hinges for doors less than 48 inches (1220 mm) high, and provide three hinges for doors more than 48 inches (1220 mm) high.
- C. Wire Pulls: Solid stainless steel wire pulls, fastened from back with two screws.
 1. For sliding doors, provide recessed stainless steel flush pulls.
 2. Provide two pulls for drawers more than 24 inches (600 mm) wide.

- D. Semirecessed Pulls: Plastic. For sliding doors, provide recessed plastic flush-pulls. Provide two pulls for drawers more than 24 inches (600 mm) wide.
- E. Door and Drawer Bumpers: Self-adhering, clear silicone rubber.
 - 1. Doors: Provide one bumper at top and bottom of closing edge of each swinging door.
 - 2. Drawers: Provide one bumper on back side of drawer front at each corner.
- F. Drawer Slides: ANSI/BHMA A156.9.
 - 1. Match existing
 - 2. Heavy Duty (Grade 1HD-100): Side mount
 - a. Type: Full extension.
 - b. Material: Zinc-plated steel slides.
 - 3. General-purpose drawers; provide 100 lb (45 kg) load capacity.
 - 4. File drawers; provide 150 lb (45 kg) load capacity.
- G. Label Holders: Stainless steel sized to receive standard label cards approximately 1 by 2 inches (25 by 51 mm), and attached with screws or brads.
 - 1. Provide label holders where indicated as existing
- H. Drawer and Hinged-Door Locks: Cylindrical (cam) type, five-pin tumbler, brass with chrome-plated finish, and complying with ANSI/BHMA A156.11, Grade 1.
 - 1. Provide a minimum of two keys per lock and six master keys.
 - 2. Provide locks on every door and drawer.
 - a. Master key for up to 500 key changes.
- I. Sliding-Door Hardware Sets: Manufacturer's standard, to suit type and size of sliding-door unit.
 - 1. Mortise-type, zinc-plated steel standards and shelf rests complying with ANSI/BHMA A156.9, Type B04071 and Type B04091.

2.4 MATERIALS

- A. Maximum Moisture Content for Lumber: 7 percent for hardwood and 12 percent for softwood.
- B. Hardwood Plywood: HPVA HP-1, particleboard core except where veneer core is indicated.
- C. Softwood Plywood: DOC PS 1.
- D. Particleboard: ANSI A208.1, Grade M-2.
- E. MDF: Medium-density fiberboard, ANSI A208.2, [Grade 130] <Insert grade>.

- F. Hardboard: ANSI A135.4, Class 1 tempered.
- G. Plastic Laminate: High-pressure decorative laminate complying with NEMA LD 3.
 - 1. Source Limitations: Obtain from single source from single manufacturer.
- H. Glass for Glazed Doors:
 - 1. Clear tempered glass complying with ASTM C1048, Kind FT, Condition A, Type I, Class 1, Quality-Q3; not less than 5.0 mm thick.

2.5 FABRICATION

- A. Plastic-Laminate-Clad Cabinet Construction: As required by referenced quality standard, but not less than the following:
 - 1. Bottoms of Cabinets, and Tops of Tall Cabinets: 3/4-inch (19-mm) particleboard or match existing.
 - 2. Shelves: 3/4-inch- (19-mm-) thick plywood or 1-inch- (25-mm-) thick particleboard.
 - 3. Backs of Casework: 3/4-inch- (19-mm-) thick particleboard or MDF where exposed, dadoed into sides, bottoms, and tops where not exposed.
 - 4. Drawer Fronts: 3/4-inch (19-mm) particleboard or matching existing.
 - 5. Drawer Sides and Backs: 1/2-inch- (13-mm-) thick with glued dovetail or multiple-dowel joints. Match existing.
 - 6. Drawer Bottoms: 1/2-inch- (13-mm-) thick particleboard or MDF glued and dadoed into front, back, and sides of drawers.
 - 7. Drawer Bodies: Steel drawer pans formed from 0.0359-inch- (0.9-mm-) thick metal, metallic phosphate treated, and finished with manufacturer's standard two-coat, baked-enamel finish consisting of prime coat and thermosetting topcoat with a minimum dry film thickness of 1 mil (0.025 mm) for topcoat and 2 mils (0.05 mm) for system.
 - 8. Cabinet Doors:
 - a. 48 Inches (1220 mm) High or Less: 3/4 inch (19 mm) thick, with particleboard or MDF cores
 - b. 48 Inches (1220 mm) or More in Height: 3/4 inches (19 mm) thick, with particleboard cores.
 - 9. Stiles and Rails of Glazed Doors:
 - a. 48 Inches (1220 mm) High or Less: 3/4 inch (19 mm) thick, with particleboard cores.
 - b. 48 Inches (1220 mm) or More in Height: 3/4 inches (17 mm) thick, with particleboard cores.
- B. Filler Strips: Provide as needed to close spaces between casework and walls, ceilings, and equipment. Fabricate from same material and with same finish as casework.

PART 3 - EXECUTION

3.1 EXAMINATION

- A. Examine areas, with Installer present, for compliance with requirements for installation tolerances, location of framing and reinforcements, and other conditions affecting performance of the Work.
- B. Proceed with installation only after unsatisfactory conditions have been corrected.

3.2 INSTALLATION

- A. Grade: Install casework to comply with same quality standard grade as item to be installed.
- B. Install casework level, plumb, and true in line; shim as required using concealed shims. Where casework abuts other finished work, apply filler strips and scribe for accurate fit, with fasteners concealed where practical.
- C. Base Cabinets: Set cabinets straight, level, and plumb. Adjust subtops within 1/16 inch (1.5 mm) of a single plane. Align similar adjoining doors and drawers to a tolerance of 1/16 inch (1.5 mm). Bolt adjacent cabinets together with joints flush, tight, and uniform.
- D. Wall Cabinets: Hang cabinets straight, level, and plumb. Adjust fronts and bottoms within 1/16 inch (1.5 mm) of a single plane. Fasten cabinets to hanging strips, masonry, framing, wood blocking, or reinforcements in walls and partitions. Align similar adjoining doors to a tolerance of 1/16 inch (1.5 mm).
- E. Fasten casework to adjacent units and to masonry, framing, wood blocking, or reinforcements in walls and partitions to comply with the AWI/AWMAC/WI's "Architectural Woodwork Standards."
- F. Install hardware uniformly and precisely. Set hinges snug and flat in mortises unless otherwise indicated. Adjust and align hardware so moving parts operate freely and contact points meet accurately. Allow for final adjustment after installation.
- G. Adjust operating hardware so doors and drawers operate smoothly without warp or bind. Lubricate operating hardware as recommended by manufacturer.

3.3 FIELD QUALITY CONTROL

- A. Inspections: Provide inspection of installed Work through WI's Certified Compliance Program certifying that woodwork, including installation, complies with requirements of the Architectural Woodwork Standards for the specified grade.
 - 1. Inspection entity to prepare and submit report of inspection.

3.4 CLEANING

- A. Repair or remove and replace defective work as directed on completion of installation.
- B. Clean finished surfaces, touch up as required, and remove or refinish damaged or soiled areas to match original factory finish, as approved by Architect.

END OF SECTION 123216

THIS PAGE IS INTENTIONALLY LEFT BLANK

SECTION 123623.13

PLASTIC-LAMINATE-CLAD COUNTERTOPS

PART 1 - GENERAL

1.1 SUMMARY

A. Section Includes:

1. Plastic-laminate-clad countertops.

1.2 ACTION SUBMITTALS

A. Product Data: For each type of product.

1. Include data for fire-retardant treatment from chemical-treatment manufacturer and certification by treating plant that treated materials comply with requirements.

B. Shop Drawings: For plastic-laminate-clad countertops.

1. Include plans, sections, details, and attachments to other work. Detail fabrication and installation, including field joints.
2. Show locations and sizes of cutouts and holes for items installed in plastic-laminate-clad countertops.
3. Apply WI Certified Compliance Program label to Shop Drawings.

C. Samples: Plastic laminates in each type, color, pattern, and surface finish required in manufacturer's standard size.

D. Samples for Initial Selection: For plastic laminates.

E. Samples for Verification: As follows:

1. Plastic Laminates: For each type, color, pattern, and surface finish required, 12 by 12 inches (300 by 300 mm) in size.
2. Fabrication Sample: For each type and profile of countertop required, provide one sample applied to core material with specified edge material applied to one edge.

1.3 INFORMATIONAL SUBMITTALS

A. Qualification Data: For Installer and fabricator.

B. Product Certificates: For the following:

1. Composite wood products.

2. High-pressure decorative laminate.
3. Chemical-resistant, high-pressure decorative laminate.
4. Adhesives.

C. Quality Standard Compliance Certificates: WI Certified Compliance Program.

D. Evaluation Reports: For fire-retardant-treated materials, from ICC-ES.

1.4 QUALITY ASSURANCE

A. Fabricator Qualifications: Shop that employs skilled workers who custom fabricate products similar to those required for this Project and whose products have a record of successful in-service performance.

1. Shop Certification: WI's Certified Compliance Program licensee.

B. Installer Qualifications: WI's Certified Compliance Program licensee.

1.5 DELIVERY, STORAGE, AND HANDLING

A. Deliver countertops only after casework and supports on which they will be installed have been completed in installation areas.

B. Store countertops in areas where environmental conditions comply with requirements specified in "Field Conditions" Article.

C. Keep surfaces of countertops covered with protective covering during handling and installation.

1.6 FIELD CONDITIONS

A. Environmental Limitations without Humidity Control: Do not deliver or install countertops until building is enclosed, wet-work is complete, and HVAC system is operating and maintaining temperature and relative humidity at levels planned for building occupants during the remainder of the construction period.

B. Environmental Limitations with Humidity Control: Do not deliver or install countertops until building is enclosed, wet-work is complete, and HVAC system is operating and maintaining temperature between 60 and 90 deg F (16 and 32 deg C) and relative humidity between 25 and 55percent during the remainder of the construction period.

C. Field Measurements: Where countertops are indicated to fit to other construction, verify dimensions of other construction by field measurements before fabrication and indicate measurements on Shop Drawings. Coordinate fabrication schedule with construction progress to avoid delaying the Work.

- D. Established Dimensions: Where countertops are indicated to fit to other construction, establish dimensions for areas where countertops are to fit. Provide allowance for trimming at site, and coordinate construction to ensure that actual dimensions correspond to established dimensions.

PART 2 - PRODUCTS

2.1 FABRICATORS

- A. Fabricators: Subject to compliance with requirements, available fabricators offering products that may be incorporated into the Work on the WI's member list.

2.2 PLASTIC-LAMINATE-CLAD COUNTERTOPS

- A. Quality Standard: Unless otherwise indicated, comply with the "Architectural Woodwork Standards" for grades of plastic-laminate-clad countertops indicated for construction, finishes, installation, and other requirements.

1. Provide inspections of fabrication and installation together with labels and certificates from WI certification program indicating that countertops comply with requirements of grades specified.
2. The Contract Documents contain requirements that are more stringent than the referenced quality standard. Comply with requirements of Contract Documents in addition to those of the referenced quality standard.

- B. Grade: Custom

- C. Chemical-Resistant, High-Pressure Decorative Laminate: NEMA LD 3, Grade HGP, and as follows:

1. Manufacturers

- a. Hartson-Kennedy Cabinet Top Co, Inc
- b. Kewaunee Scientific Corporation
- c. Wilsonart International, Inc
- d. Stolo Cabinets, Inc

2. Laminate has the following ratings when tested with indicated reagents in accordance with NEMA LD 3, Test Procedure 3.9.5:

- a. Nitric Acid (30 Percent): Moderate effect.
- b. Sulfuric Acid (77 Percent): Moderate effect.
- c. Hydrochloric Acid (37 Percent): Moderate effect.
- d. Phosphoric Acid (75 Percent): No effect.
- e. Acetic Acid (98 Percent): No effect.
- f. Formaldehyde: No effect.
- g. Ethyl Acetate: No effect.
- h. Ethyl Ether: No effect.

- i. Phenol (85 Percent): Moderate effect.
- j. Benzene: No effect.
- k. Xylene: No effect.
- l. Butyl Alcohol: No effect.
- m. Furfural: No effect.
- n. Methyl Ethyl Ketone: No effect.
- o. Sodium Hydroxide (25 Percent): No effect.
- p. Sodium Sulfide (15 Percent): No effect.
- q. Ammonium Hydroxide (28 Percent): No effect.
- r. Zinc Chloride: No effect.
- s. Gentian Violet: No effect.
- t. Methyl Red: No effect.

D. Colors, Patterns, and Finishes: Provide materials and products that result in colors and textures of exposed laminate surfaces complying with the following requirements:

- 1. As indicated on drawings.

E. Edge Treatment: Same as laminate cladding on horizontal surfaces as same as existing

F. Core Material: Same as existing

G. Core Material at Sinks: Particleboard made with exterior glue, MDF made with exterior glue, or exterior-grade plywood.

H. Core Thickness: 1-1/8 inch (29 mm).

I. Backer Sheet: Provide plastic-laminate backer sheet, NEMA LD 3, Grade BKL, on underside of countertop substrate.

J. Paper Backing: Provide paper backing on underside of countertop substrate.

2.3 WOOD MATERIALS

A. Wood Products: Provide materials that comply with requirements of referenced quality standard unless otherwise indicated.

- 1. Wood Moisture Content: 4 to 9 percent.

B. Composite Wood Products: Provide materials that comply with requirements of referenced quality standard for each type of countertop and quality grade specified unless otherwise indicated.

- 1. MDF: Medium-density fiberboard, ANSI A208.2, Grade 130
- 2. Particleboard: ANSI A208.1, Grade M-2.
- 3. Softwood Plywood: DOC PS 1.

2.4 FIRE-RETARDANT-TREATED MATERIALS

- A. Fire-Retardant-Treated Materials, General: Where fire-retardant-treated materials are indicated, use materials that are acceptable to authorities having jurisdiction and with fire-test-response characteristics specified as determined by testing identical products in accordance with test method indicated by a qualified testing agency.
1. Use treated materials that comply with requirements of referenced quality standard. Do not use materials that are warped, discolored, or otherwise defective.
 2. Use fire-retardant-treatment formulations that do not bleed through or otherwise adversely affect finishes. Do not use colorants to distinguish treated materials from untreated materials.
 3. Identify fire-retardant-treated materials with appropriate classification marking of qualified testing agency in the form of removable paper label or imprint on surfaces that will be concealed from view after installation.
- B. Fire-Retardant-Treated Lumber and Plywood: Products with a flame-spread index of 25 or less when tested in accordance with ASTM E84, with no evidence of significant progressive combustion when the test is extended an additional 20 minutes, and with the flame front not extending more than 10.5 feet (3.2 m) beyond the centerline of the burners at any time during the test.
1. Kiln dry lumber and plywood after treatment to a maximum moisture content of 19 and 15 percent, respectively.
 2. For items indicated to receive a stained or natural transparent finish, use organic resin chemical formulation.
 3. Mill lumber after treatment within limits set for wood removal that do not affect listed fire-test-response characteristics, using a woodworking shop certified by testing and inspecting agency.
- C. Fire-Retardant Particleboard: Made from softwood particles and fire-retardant chemicals mixed at time of panel manufacture to achieve flame-spread index of 25 or less and smoke-developed index of 25 or less when tested in accordance with ASTM E84.
1. For panels 3/4 inch (19 mm) thick and less, comply with ANSI A208.1 for Grade M-2 except for the following minimum properties: modulus of rupture, 1600 psi (11 MPa); modulus of elasticity, 300,000 psi (2070 MPa); internal bond, 80 psi (550 kPa); and screw-holding capacity on face and edge, 250 and 225 lbf (1100 and 1000 N), respectively.
 2. For panels 13/16 to 1-1/4 inches (20 to 32 mm) thick, comply with ANSI A208.1 for Grade M-1 except for the following minimum properties: modulus of rupture, 1300 psi (9 MPa); modulus of elasticity, 250,000 psi (1720 MPa); linear expansion, 0.50 percent; and screw-holding capacity on face and edge, 250 and 175 lbf (1100 and 780 N), respectively.
- D. Fire-Retardant MDF: Medium-density fiberboard panels complying with ANSI A208.2, made from softwood fibers, synthetic resins, and fire-retardant chemicals mixed together at time of panel manufacture to achieve flame-spread index of 25 or less and smoke-developed index of 200 or less in accordance with ASTM E84.

2.5 ACCESSORIES

- A. Wire-Management Grommets: Circular, molded-plastic grommets and matching plastic caps with slot for wire passage.
 - 1. Outside Diameter: 2 inches (51 mm)
 - 2. Color: Brown or match existing

2.6 MISCELLANEOUS MATERIALS

- A. Adhesive for Bonding Plastic Laminate: As selected by fabricator to comply with low or no VOC limit requirements.
 - 1. Adhesive for Bonding Edges: Hot-melt adhesive or adhesive specified above for faces.

2.7 FABRICATION

- A. Sand fire-retardant-treated wood lightly to remove raised grain on exposed surfaces before fabrication.
- B. Fabricate countertops to dimensions, profiles, and details indicated. Provide front and end overhang of 1 inch (25 mm) over base cabinets. Ease edges to radius indicated for the following:
 - 1. Solid-Wood (Lumber) Members: 1/16 inch (1.5 mm) unless otherwise indicated.
- C. Complete fabrication, including assembly, to maximum extent possible before shipment to Project site. Disassemble components only as necessary for shipment and installation. Where necessary for fitting at site, provide ample allowance for scribing, trimming, and fitting.
 - 1. Seal edges of cutouts by saturating with varnish.

PART 3 - EXECUTION

3.1 PREPARATION

- A. Before installation, condition countertops to average prevailing humidity conditions in installation areas.
- B. Before installing countertops, examine shop-fabricated work for completion and complete work as required, including removal of packing.

3.2 INSTALLATION

- A. Grade: Install countertops to comply with same grade as item to be installed.

- B. Assemble countertops and complete fabrication at Project site to the extent that it was not completed in the shop.
 - 1. Provide cutouts for appliances, plumbing fixtures, electrical work, and similar items. Locate openings accurately, and use templates or roughing-in diagrams to produce accurately sized and shaped openings. Sand edges of cutouts to remove splinters and burrs.
 - 2. Seal edges of cutouts by saturating with varnish.
- C. Field Jointing: Where possible, make in the same manner as shop jointing, using dowels, splines, adhesives, and fasteners recommended by manufacturer. Prepare edges to be joined in shop so Project-site processing of top and edge surfaces is not required. Locate field joints where shown on Shop Drawings.
 - 1. Secure field joints in countertops with concealed clamping devices located within 6 inches (150 mm) of front and back edges and at intervals not exceeding 24 inches (600 mm). Tighten in accordance with manufacturer's written instructions to exert a constant, heavy-clamping pressure at joints.
- D. Scribe and cut countertops to fit adjoining work, refinish cut surfaces, and repair damaged finish at cuts.
- E. Fire-Retardant-Treated Wood: Handle, store, and install fire-retardant-treated wood to comply with chemical-treatment manufacturer's written instructions, including those for adhesives used to install woodwork.
- F. Countertop Installation: Anchor securely by screwing through corner blocks of base cabinets or other supports into underside of countertop.
 - 1. Install countertops level and true in line. Use concealed shims as required to maintain not more than a 1/8-inch-in-96-inches (3-mm-in-2400-mm) variation from a straight, level plane.
 - 2. Secure backsplashes to tops with concealed metal brackets at 16 inches (400 mm) o.c. and to walls with adhesive.
 - 3. Seal joints between countertop and backsplash, if any, and joints where countertop and backsplash abut walls with mildew-resistant silicone sealant or another permanently elastic sealing compound recommended by countertop material manufacturer.

3.3 ADJUSTING AND CLEANING

- A. Repair damaged and defective countertops, where possible, to eliminate functional and visual defects. Where not possible to repair, replace countertops. Adjust joinery for uniform appearance.
- B. Clean countertops on exposed and semiexposed surfaces.
- C. Protection: Provide Kraft paper or other suitable covering over countertop surfaces, taped to underside of countertop at a minimum of 48 inches (1220 mm) o.c. Remove protection at Substantial Completion.

END OF SECTION 123623.13

**DSH METROPOLITAN SNF BUILDING REPAIR
DSH - METRO
DEPARTMENT OF STATE HOSPITAL
JCCA # 17038-1**

SUBMITTAL REVIEW

Submitted By: KAZONI CONSTRUCTION

Date Received:

Submittal No.:

Date Returned:

Reviewed By: JCCA

Description:

REVIEWED	REJECTED
REVISE AND RESUBMIT	FURNISH AS CORRECTED
<p>CORRECTIONS OR COMMENTS MADE ON THE SHOP DRAWINGS DURING THIS REVIEW DO NOT RELIEVE THE CONTRACTOR FROM COMPLIANCE WITH REQUIREMENTS OF THE DRAWINGS AND SPECIFICATIONS. THIS CHECK IS ONLY FOR REVIEW OF THE GENERAL CONFORMANCE WITH THE DESIGN CONCEPT OF THE PROJECT AND GENERAL COMPLIANCE WITH THE INFORMATION GIVEN IN CONTRACT DOCUMENTS. THE CONTRACTOR IS RESPONSIBLE FOR CONFIRMING AND CORRELATING ALL QUANTITIES AND DIMENSIONS; SELECTING FABRICATION PROCESSES AND TECHNIQUES OF CONSTRUCTION; COORDINATING HIS OR HER WORK WITH THAT OF ALL OTHER TRADES AND PERFORMING ALL WORK IN A SAFE AND SATISFACTORY MANNER.</p>	
BY _____	DATE _____
J.C. CHANG & ASSOCIATES, INC.	

Comments:



Submittal Transmittal Form No.: 17r2

Revision No.: _____

Specification Section: _____

Project No.: 1590014

Project: DSH Metropolitan SNF Building Repair

General Contractor: Kazoni Construction

Subcontractor/Supplier: Complete Access Solutions

Attention: J.C. Chang & Associates

Contract Drawing Reference: _____

Review and commentary noted below are for general conformance with (1) the AOR's design concept of the project and (2) the information given in the contract documents and for no other purpose. Commentary below is subject to the requirements of the contract agreement with the owner and/or subject to AOR's review/approval.

- Reviewed by General Contractor
- Furnish as Corrected/Noted
- Revise and Resubmit
- Submit Specific Item
- Rejected

Reviewed By: KK

Date: 4/3/2024

Date Needed by from Architect:

4/17/2024

Remarks:

Please find the following submittal attachments:

Transom core spec and installation per manufacturer

Signed: Keith Kulpinski

September, 2010

L LABELED

TRANSOM PANELS

SPECIFY USE OF PANEL AND LIST NOMINAL FRAME OPENING FOR CORRECT PANEL UNDERSIZING.

1/2" (12.7) PANEL MINERAL FIBREBOARD CORE
~~20, 18, OR~~ 16 GA. FACE SKINS

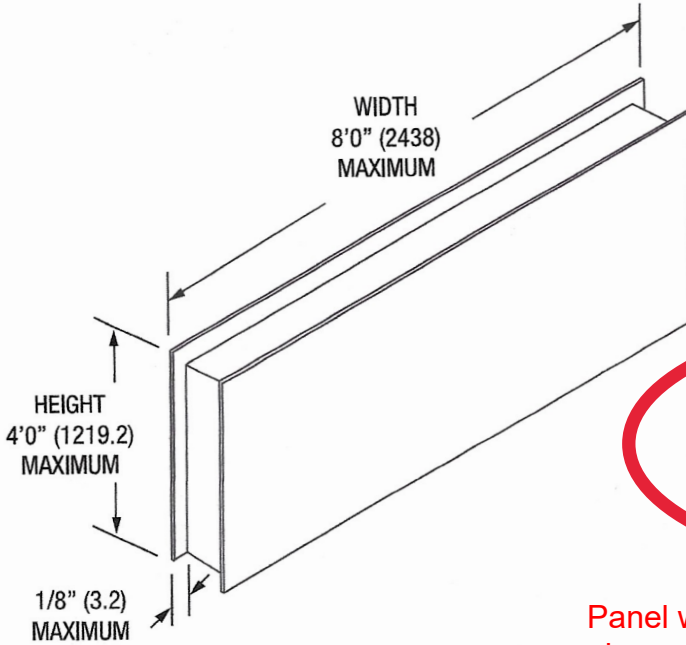

PANEL INSTALLATION OPTIONS:

1. PANEL INSTALLED WITH GLASS STOP
2. PANEL INSTALLED INTO DOOR WINDOW KIT

Panel will be installed with glass stop per manufacturers installation requirements

SIDE PANELS AND/OR DOOR PANELS

SPECIFY USE OF PANEL AND LIST NOMINAL FRAME OPENING FOR CORRECT PANEL UNDERSIZING.

1/2" (12.7) PANEL MINERAL FIBREBOARD CORE
~~20, 18, OR~~ 16 GA. FACE SKINS

NOTE: REFERENCE LABEL SECTION OF TECH DATA MANUAL FOR MAXIMUM SQUARE INCH SIZE CAPABILITIES FOR DOORS AND FRAMES.

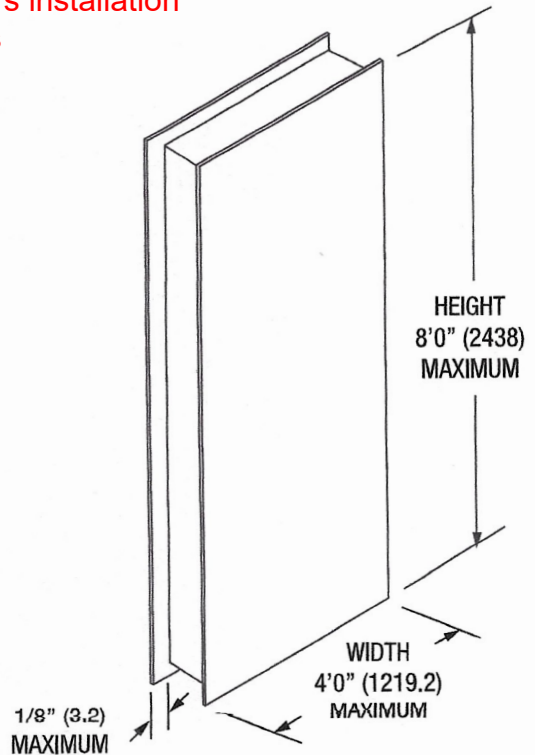
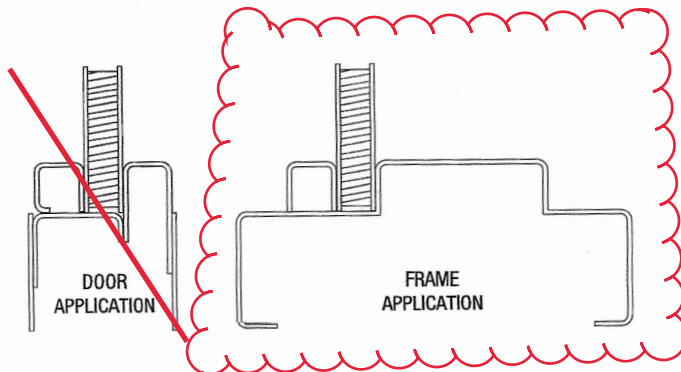

90 Min Fire Rating
16 Guage Material

Experience a safer and more open world

OPNG. No.	30	DOOR OPNG.		DOOR SWING	FIRE LABEL	1/2" MIN. (5)	HINGES	STRIKE	CLOSER	MUTE	MISC.
		WIDTH	HEIGHT								

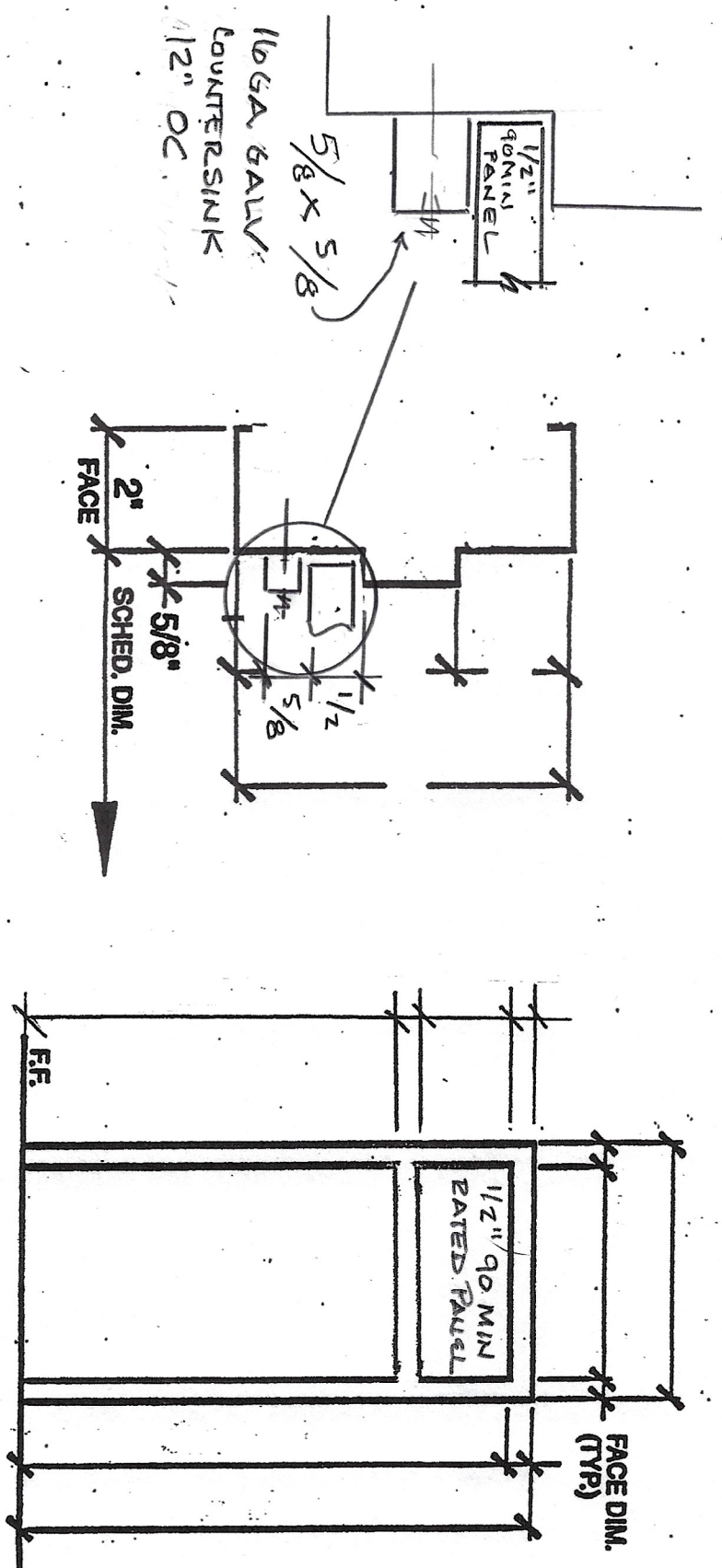

MATERIAL	WELD	ANCHORS	FLOOR	WALL TYPE	ELEV.
FINISH PRIME	KD-DW	EA. JAMB	HEAD	PLAN REF.	
	N/D		SILL MORTAR BOX		

CONTRACTORS DOOR SUPPLY

ELEVATION

JOB No.	
SHEET No.	

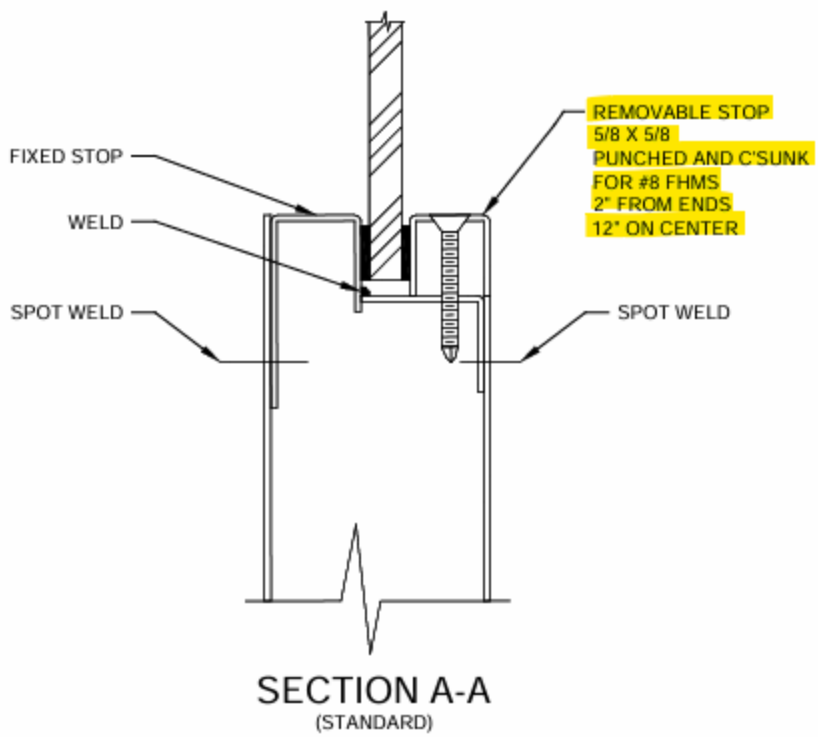



Search

Close



Login / Signup



My account v



Cart

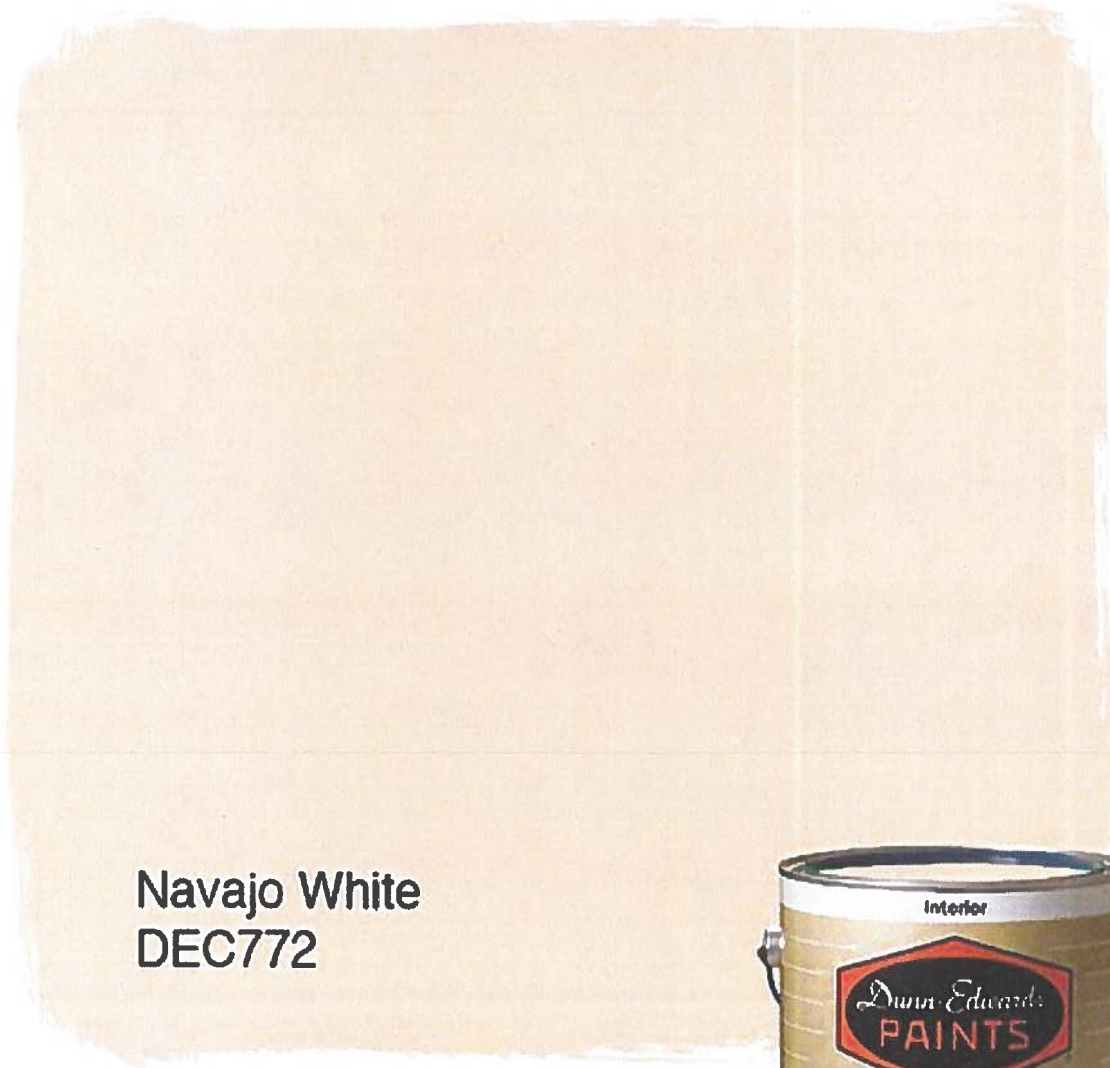

Navajo White
DEC772



★ Reviews



Navajo White DEC 772

DUNN-EDWARDS PAINTS SKU: SPMA50-1-L-1

Paint Type: Suprema

[Explore our paint types](#)

Interior	Exterior
Exquisite	Suprema
Everest	Spartawall
Aristoshield	

Sheen: Semi-Gloss

Flat	Velvet
Eggshell	Low Sheen
Semi-Gloss	

Size: Gallon

Gallon

Price: \$70.50

Quantity: 1

Description

Color Disclaimer:

★ Reviews



Search

Close



Login / Signup



My account v



Cart

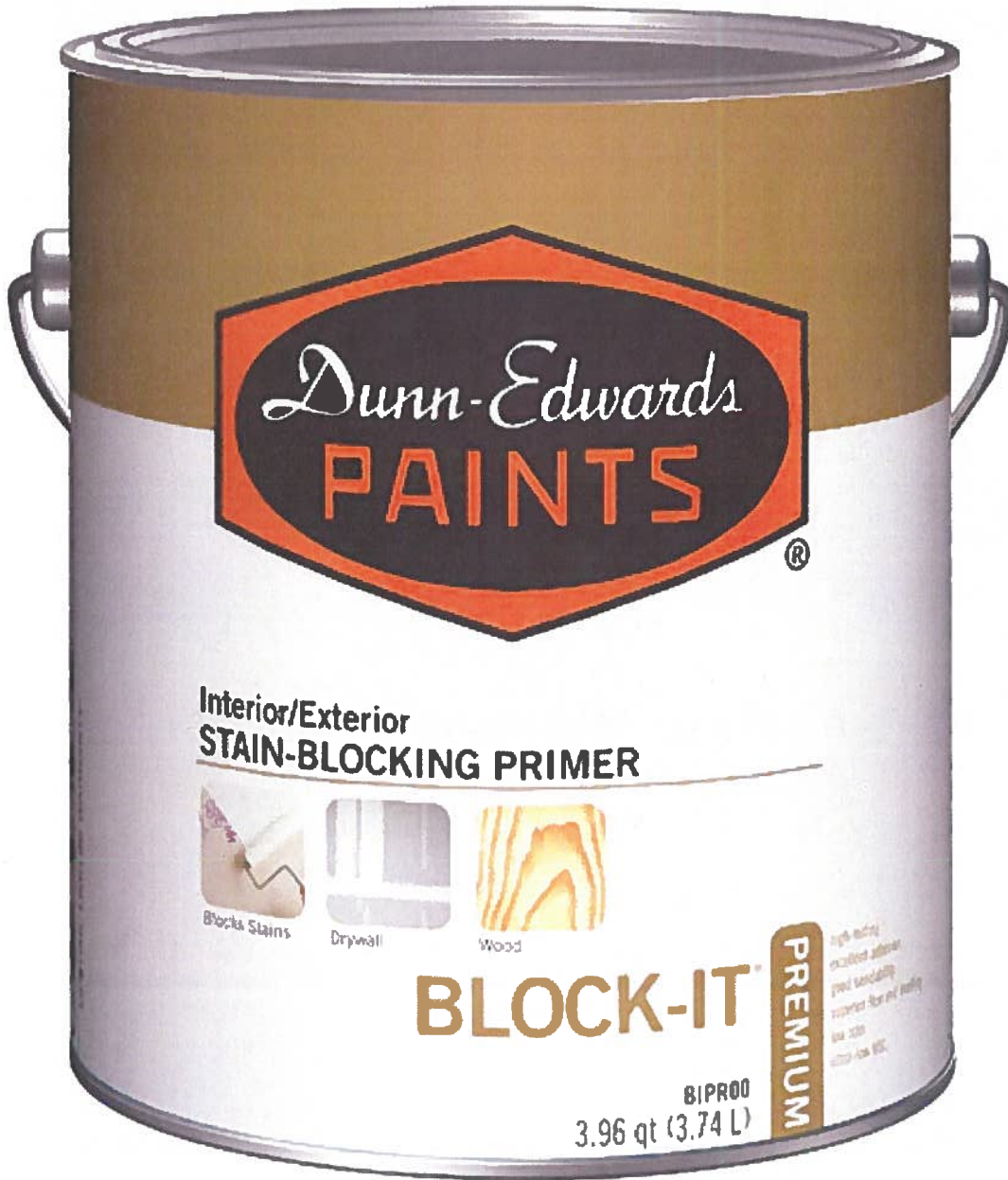

★ Reviews



BLOCK-IT Premium Interior/Exterior Primer

DUNN-EDWARDS PAINTS SKU: BIPR00-1-WH-1

Description

BLOCK-IT[®] Premium is a high-hiding, ultra-low VOC waterborne alkyd primer for use on a variety of previously painted or new interior and exterior surfaces. BLOCK-IT[®] Premium is excellent for blocking stains from food and grease, water or smoke damage, ballpoint or felt pen ink, lipstick, crayon, and tannin from woods such as cedar or redwood. Its innovative formulation also provides excellent adhesion and enamel holdout, good sandability, low odor, and superior flow-and-leveling for easy brush and roller application.

Excellent for stains such as food and grease, water or smoke damage, ballpoint or felt pen ink,

[View more](#)

★ Reviews

Estimate shipping

Country

United States

Province

Alabama

Zip code

OLD MASTERS® WOOD STAINS

GEL STAIN

Old Masters® Gel Stain is a highly pigmented, oil-based stain designed to achieve intense colors on interior and exterior wood, fiberglass, metal and composition surfaces. Its thick formula allows easy application, exceptional adhesion and superior color control. Ideal for difficult-to-stain woods such as pine, poplar, maple, plywood and veneers, as well as nonporous surfaces including metal, composition (Masonite), interior and exterior fiberglass doors and plastic moldings. Gel Stain comes in 21 factory-mixed colors and can also be intermixed or tinted to achieve custom colors.

"Specially formulated for use on interior and exterior wood, fiberglass, metal and composition surfaces."

WATER-BASED WOOD STAIN

Old Masters® Water-Based Wood Stain enhances the beauty of bare wood surfaces with intense color. Its water-based formula allows easy application, fast drying and low odor. Ideal for use on cabinets, furniture, doors, trim, crafts, floors and much more. Old Masters Water-Based Wood Stain is available in 10 popular colors. A Natural Tint Base is available to tint and mix an endless number of colors. This stain is non-toxic, child-safe when dry and cleans easily with soap and water.

"Fast drying, semi-transparent wood stain with low odor and easy water clean up."



OLD MASTERS® COLOR SELECTIONS

Penetrating, Wiping and Gel Stain are available in 21 popular colors. Custom colors can be achieved by tinting Old Masters Natural Tint Base or by tinting any of the 21 ready-mixed stain colors. Pickling White can also be used to create contemporary Santa Fe colors, featured on page 12 of the Project Guide. Old Masters Water-Based Wood Stain is currently available in 10 ready-mixed* stain colors. A Natural Tint Base is available to tint and mix an endless number of colors.



Cedar*



Cherry



Dark Mahogany*



Dark Walnut



Early American*

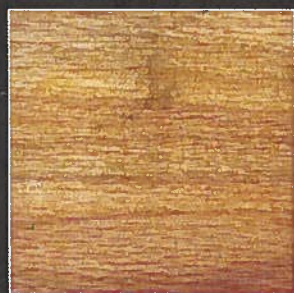

Fruitwood

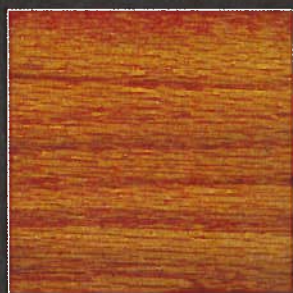

Golden Oak*



Maple



Natural/Tint Base*

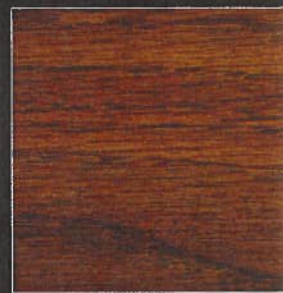

Provincial*

NOTE: Color Samples printed in this brochure are reproduced as accurate as modern printing techniques permit. Color will vary according to application technique, surface type and wood species.